

# LISTINO 28/2026

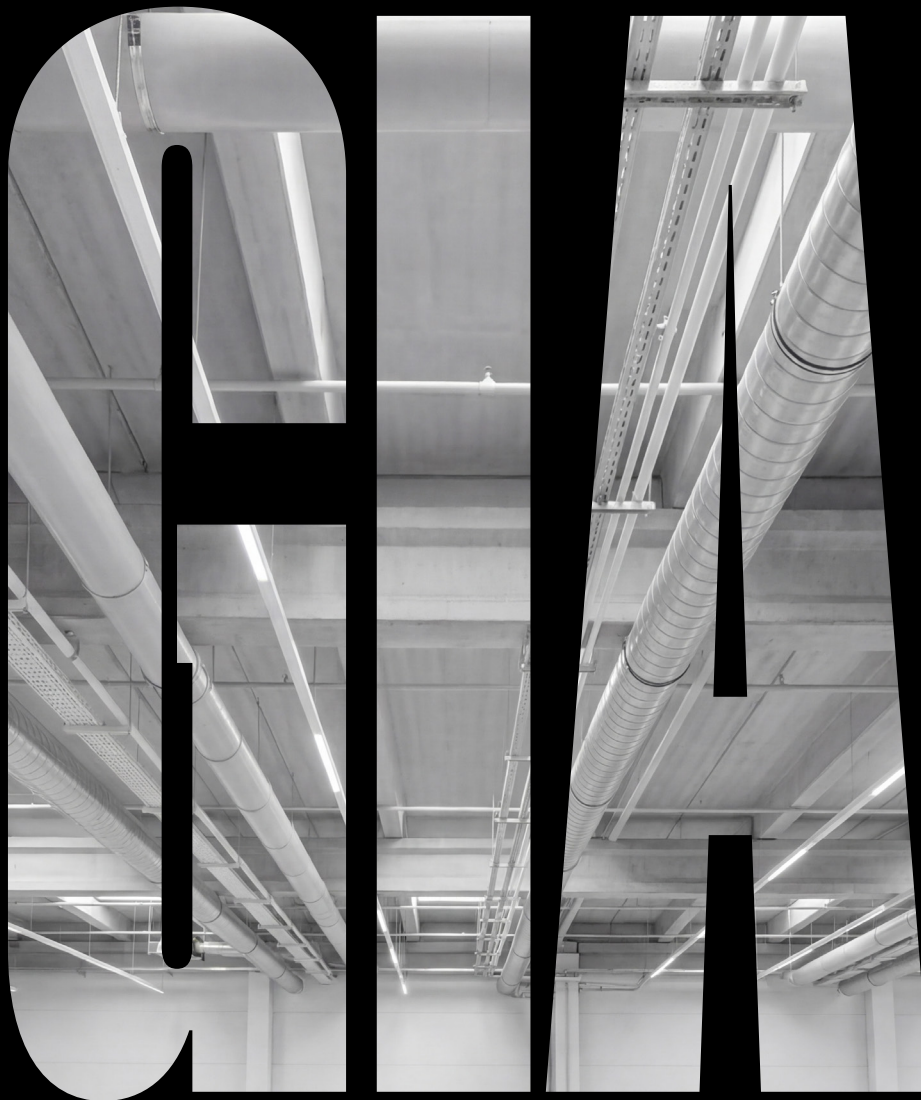

**HVAC-R • IDROTERMOSANITARIO • FISSAGGIO**

una completa selezione di prodotti raccolti in un unico catalogo  
per garantire qualità e servizio ai massimi livelli.

**gia**  
Fissaggi brevettati

**DIVERSITECH**®

# 2026

## LA PIÙ AMPIA SCELTA DI PRODOTTI HVAC/R

GIA è diventata ufficialmente l'hub di riferimento e il polo logistico strategico per i marchi del gruppo DiversiTech in Italia. Grazie al potenziamento del nostro centro di distribuzione e alla sinergia con la leadership mondiale di DiversiTech nel settore HVAC/R e del fissaggio, oggi GIA si pone come unico punto di contatto per un'offerta senza precedenti.



# SIMPLIFY YOUR WORK

ARCTIC  
HAYES

ARTIPLASTIC<sup>®</sup>  
SMART PLASTIC SOLUTIONS

Castel<sup>®</sup>  
engineering

PUMP  
HOUSE

gia

GUS

ilp

niccons<sup>®</sup>

Rodigas<sup>®</sup>

VoRPA<sup>®</sup>  
ANCHORS & FIXINGS

**DIVERSITECH<sup>®</sup>**

Fondata nel 1971, DiversiTech<sup>®</sup> Corporation è il principale produttore di componenti HVAC/R in Nord America, con un ampio portfolio di oltre 200 categorie di prodotti. Grazie ad un'offerta diversificata, costantemente migliorata e progettata per rispondere alle esigenze specifiche dei professionisti del settore, DiversiTech<sup>®</sup> si distingue per la qualità della produzione e per un servizio clienti d'eccellenza. DiversiTech<sup>®</sup> è il partner ideale per semplificare le installazioni e garantire soluzioni efficaci. La semplicità di un lavoro eseguito in modo impeccabile è a portata di mano.

# UNA SOLIDA COMPETENZA MANUFATTURIERA

## Precisione, resistenza e sostenibilità

Gestiamo una rete di stabilimenti produttivi all'avanguardia in Europa, specializzati nella gestione di specifiche lavorazioni e diverse tipologie di materiali, a testimonianza del nostro costante impegno verso l'innovazione e la qualità.

### Lavorazione delle Materie Plastiche

Gli stabilimenti di produzione delle materie plastiche sono dotati di macchinari all'avanguardia per lo stampaggio e l'iniezione, con capacità variabili da 25T fino a 900T e di tecnologie di mono e bi-estrusione.

Operativi 24 ore su 24, questi impianti realizzano profili in PVC di qualsiasi dimensione e forma, integrando lavorazioni essenziali come l'applicazione del film protettivo per i raggi UV.

### Lavorazione dell'acciaio

Gli stabilimenti dedicati alla lavorazione dei metalli producono stampi e componenti certificati e conformi ai criteri più rigorosi del settore. L'impiego di processi completamente automatizzati garantisce un triplice beneficio: efficienza operativa, precisione millimetrica e la totale tracciabilità di ogni pezzo.

### Lavorazione della Gomma

La sostenibilità è il fondamento della nostra produzione di gomma: in questo processo, i pneumatici d'auto esausti vengono trasformati in soluzioni antivibranti eleganti e resistenti, con caratteristiche funzionali eccellenti per fungere da supporti. Questa prassi riduce significativamente l'impatto ambientale e sostiene i principi dell'economia circolare.



# DISTRIBUZIONE EUROPEA. PRODUZIONE EUROPEA.

DiversiTech opera in Europa con un network di aziende produttive, riconosciute per esperienza e competenza. Questa struttura garantisce qualità in ogni fase del processo produttivo, rafforzando il nostro impegno verso l'eccellenza e l'innovazione. Con attenzioni dedicate per paese, forniamo soluzioni a livello locale che integrano efficienza, flessibilità e attenzione ai dettagli. Il supporto nostri distribution center ci permette di semplificare i processi di acquisto e ridurre significativamente i tempi di consegna.



Guarda il video e visita le nostre fabbriche

Stampaggio gomma

Centro di distribuzione

Centro di distribuzione

Lavorazioni acciaio

Centro di distribuzione

Estrusione e stampaggi polimeri

Stampaggio gomma

Estrusione e stampaggi polimeri

Produzione collari e fissaggi

Centro di distribuzione

Head Quarter

Stampaggio gomma

Stampaggi e lavorazioni acciaio

Produzione fissaggi



# DISPONIBILITÀ IMMEDIATA E CRESCITA CONDIVISA CON I NOSTRI CLIENTI

## Certifichiamo la nostra qualità

L'affidabilità e il valore dei prodotti GIA sono garantiti dall'uso di materie prime di qualità e sistemi innovativi, entrambi certificati a livello nazionale e conformi alle normative europee. L'impegno di GIA si riconosce inoltre nella volontà di sviluppare prodotti innovativi e sistemi brevettati in grado di rispondere alle mutevoli esigenze dell'installatore in cantiere.



## Servizio Tecnico vicino a te

Con il nostro team di tecnici distribuiti sul territorio italiano, siamo sempre pronti ad aiutarti dove ce n'è bisogno. Contattaci per richiedere una visita gratuita direttamente in cantiere o presso la Tua azienda. Ti aiuteremo a selezionare le migliori soluzioni di fissaggio.



## Al Fianco degli Installatori

Da oltre quarant'anni GIA è al fianco degli installatori, perseguendo l'eccellenza nell'innovazione. Le nostre soluzioni nascono dall'ascolto delle reali necessità di chi opera sul campo, per agevolare il lavoro e ottimizzare i tempi. Grazie a un dialogo continuo con i nostri clienti garantiamo l'affidabilità dei prodotti, progettati per offrire prestazioni che superano le aspettative.



## Servizio Antisismico

Il servizio tecnico in sede è a disposizione per verifiche antisismiche e relazioni di calcolo. Assistenza telefonica gratuita.

Assistenza tecnica  
[assistenza@gia.it](mailto:assistenza@gia.it)

Supporto tecnico  
**0321.77.71.42**



## Soluzioni per il Cantiere

L'impegno di GIA per il cantiere si traduce in prodotti innovativi e di qualità, interamente concepiti e realizzati in Italia. Il controllo diretto dell'intero processo produttivo, dalla selezione delle materie prime al collaudo tecnico, si traduce in soluzioni robuste ed efficienti, per le sfide dei cantieri più impegnativi.

# INDICE

## IDROTERMOSANITARIO

1.	FISSAGGI PER RADIATORI .....	14
2.	FISSAGGI SANITARI .....	22
3.	COLLARI E FISSAGGI PER TUBAZIONI .....	38
4.	ACCESSORI DI FISSAGGIO .....	78
5.	ANCORANTI E SIGILLANTI .....	86
6.	SISTEMI DI FISSAGGIO INDUSTRIALE .....	104
7.	FISSAGGI INOX.....	140
8.	FISSAGGI PER SOLARE TERMICO .....	154

## HVAC/R

9.	CANALINE E ACCESSORI .....	162
10.	STAFFE ED ACCESSORI PER UNITÀ ESTERNE.....	184
11.	SUPPORTI A PAVIMENTO .....	196
12.	SCARICO DELLA CONDENSA.....	212
13.	SCATOLE DI PREDISPOSIZIONE AD INCASSO .....	228
14.	PRODOTTI COMPLEMENTARI .....	236

# 1. FISSAGGI PER RADIATORI

La gamma di fissaggi per radiatori di GIA è uno dei comparti storici dell'azienda, con radici che risalgono al 1978, anno del primo brevetto: la mensola da muro telescopica con tassello regolabile. Questo articolo, tuttora presente a catalogo, si distingue per il caratteristico tassello a forma di spina elastica e per lo smusso di raccordo al codulo del radiatore, elementi che ne hanno consolidato affidabilità e riconoscimento sul mercato.

Nel tempo, la gamma si è ampliata includendo mensole con ancorante a battuta e modelli specifici per pareti con isolante o cartongesso. A completamento della proposta, il catalogo offre accessori e piedini di supporto, studiati per garantire fissaggi stabili, versatili e conformi agli standard tecnici, adatti a ogni tipo di radiatore.

SCOPRI DI PIÙ,  
INQUADRA IL  
QR CODE

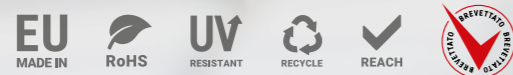

## Mensole per radiatori su muratura

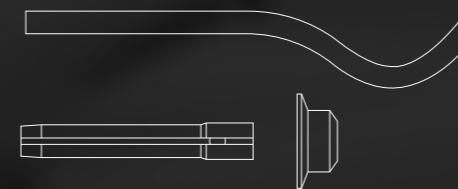

C3-C4

Mensole telescopiche smussate per radiatori in ghisa a 2 colonne

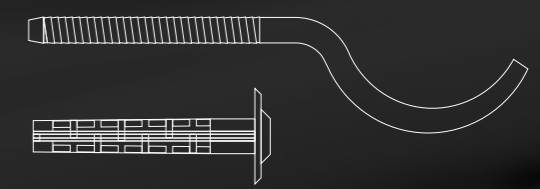

MR-T

Mensole smussate per radiatori tubolari

## Mensole per radiatori su cartongesso

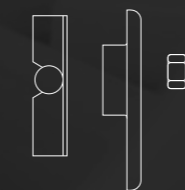

G-MAGIC

Mensola per cartongesso, per radiatori in alluminio e tubolari fino a 4 colonne

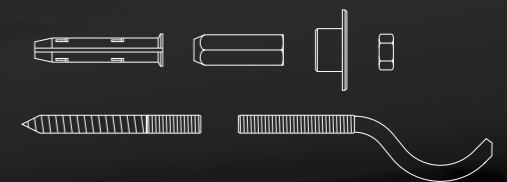

ISOMEN

Mensola per pareti in muratura con isolante e per pareti in cartongesso

## L/M/C

Mensole telescopiche smussate per radiatori in ghisa e tubolari in buste trasparenti da 2 pz/cad



Cod. europeo	Cod. fabbrica	Tipo	Colonne	Conf. (pz)	Imballo (conf)	Pallet (conf)	€/conf
9901-0701-01	010101	L2 BIANCA	> 6	2	30	720	13,630
9901-0800-00	010000	L	5/6	2	35	945	10,420
9901-0700-01	010001	L BIANCA	5/6	2	35	945	10,270
9901-0810-00	011000	M	4	2	35	945	9,240
9901-0710-01	011001	M BIANCA	4	2	35	945	9,560
9901-0820-00	012000	C	2/3	2	35	945	8,380
9901-0720-01	012001	C BIANCA	2/3	2	35	945	8,630

## C2 BIANCA

Mensola telescopica smussata per radiatori in ghisa 2 colonne in buste trasparenti da 2 pz/cad



Cod. europeo	Cod. fabbrica	Tipo	Colonne	Conf. (pz)	Imballo (conf)	Pallet (conf)	€/conf
9901-0121-01	012101	C2 BIANCA	2	2	40	2240	5,640

## C3/C4 BIANCA

Mensole telescopiche smussate per radiatori tubolari in buste trasparenti da 2 pz/cad



Cod. europeo	Cod. fabbrica	Tipo	Colonne	Conf. (pz)	Imballo (conf)	Pallet (conf)	€/conf
9901-0122-01	012201	C3 BIANCA	2/3	2	50	1350	6,080
9901-0123-01	012301	C4 BIANCA	3/4	2	50	1350	6,620

## A/A1

Mensole telescopiche smussate per radiatori in alluminio in buste trasparenti da 2 pz/cad



Cod. europeo	Cod. fabbrica	Tipo	Descrizione	Conf. (pz)	Imballo (conf)	Pallet (conf)	€/conf
9901-0230-00	013000	A	Sezione circolare	2	80	2160	4,710
9901-0130-01	013001	A BIANCA	Sezione circolare	2	80	2160	4,670
9901-0231-00	013100	A1	Coduli stretti	2	80	2160	6,380
9901-0131-01	013101	A1 BIANCA	Coduli stretti	2	80	2160	6,110

## MR-A1 BIANCA

Mensola piatta per radiatori in alluminio in buste trasparenti da 2 pz/cad



Cod. europeo	Cod. fabbrica	Tipo	Descrizione	Conf. (pz)	Imballo (conf)	Pallet (conf)	€/conf
9901-0531-06	013106	MR-A1 BIANCA	Verniciata	2	80	2160	4,040

## MR-T/MR-GT BIANCA

Mensole smussate per radiatori tubolari in buste trasparenti da 2 pz/cad



Cod. europeo	Cod. fabbrica	Tipo	Colonne	Conf. (pz)	Imballo (conf)	Pallet (conf)	€/conf
9901-0522-06	012206	MR-T3 BIANCA	Tubolari - 2 colonne	2	50	1350	5,200
9901-0523-06	012306	MR-T4 BIANCA	Tubolari - 3 colonne	2	50	1350	5,660
9901-0524-06	012406	MR-T5 BIANCA	Tubolari - 4 colonne	2	35	945	6,910
9901-0500-06	010006	MR-GT6 BIANCA	Tubolari e ghisa- 5/6 col.	2	35	945	8,300

## AC1/AC2

Mensole telescopiche per radiatori lamellari in buste trasparenti da 2 pz/cad



Cod. europeo	Cod. fabbrica	Tipo	Conf. (pz)	Imballo (conf)	Pallet (conf)	€/conf
9901-0250-00	015000	AC1	2	80	2160	4,650
9901-0251-00	015100	AC2	2	80	2160	5,570

## ISOMEN

Mensola per pareti in muratura con isolante o cartongesso in scatola da 2 pz/cad



Cod. europeo	Cod. fabbrica	Tipo	Descrizione	Conf. (pz)	Imballo (conf)	Pallet (conf)	€/conf
9901-0122-06	122201	ISOMEN	Giolli Ø12	2	10	560	56,390

## G-MAGIC

Mensola per pareti in cartongesso in buste trasparenti da 2 pz/cad



Cod. europeo	Cod. fabbrica	Tipo	Descrizione	Conf. (pz)	Imballo (conf)	Pallet (conf)	€/conf
9901-1060-20	016020	G-MAGIC	Per alluminio e tubolari fino a 4 colonne	2	10	270	25,520

## GST/ST 35

Gambo e sega a tazza in scatola



Cod. europeo	Cod. fabbrica	Tipo	Descrizione	Conf. (pz)	Imballo (conf)	Pallet (conf)	€/conf
9901-1000-00	230000	GST	Gambo 8,5 mm per tazza 32-210 mm	1	5	600	29,690
9901-1000-10	230010	ST 35	Tazza 35 mm	1	5	900	21,790

## MP/MP PIÙ

Piedino per radiatori in ghisa e acciaio in scatola



Cod. europeo	Cod. fabbrica	Tipo	Descrizione	Conf. (pz)	Imballo (conf)	Pallet (conf)	€/conf
9901-2080-00	018000	MP	Senza scocca	2	5	120	90,930
9901-2080-01	018001	MP PIÙ	Con scocca	2	5	120	134,200

## MP1

Piedino per radiatori in ghisa o tubolari in scatola



Cod. europeo	Cod. fabbrica	Tipo	Conf. (pz)	Imballo (conf)	Pallet (conf)	€/conf
9901-2080-06	018006	MP1	2	6	336	45,380

## MP2

Piedino per radiatori in alluminio in scatola

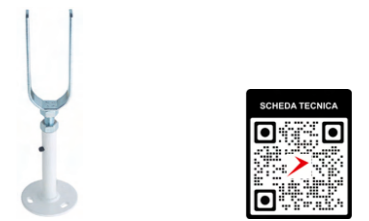

Cod. europeo	Cod. fabbrica	Tipo	Conf. (pz)	Imballo (conf)	Pallet (conf)	€/conf
9901-2080-08	018008	MP2	2	6	336	51,340

## SC01

Scocca di copertura piedini in scatola



Cod. europeo	Cod. fabbrica	Tipo	Descrizione	Conf. (pz)	Imballo (conf)	Pallet (conf)	€/conf
9901-2080-11	018011	SC01	Bianca	-	10	560	4,370

## RAN

Ranella copriforo per mensola telescopica  
in scatola



Cod. europeo	Cod. fabbrica	Tipo	Dimensioni (mm)	Conf. (pz)	Imballo (conf)	Pallet (conf)	€/conf
9901-0890-00	269000	RAN 10 A	10A - Ø 10	-	100	12000	0,420
9901-0890-01	269001	RAN 12 G	12G - Ø 12	-	100	12000	0,430
9901-0890-02	269002	RAN 15 G	15G - Ø 15	-	100	12000	0,460

## DIMA

Universale per attacchi radiatori  
in scatola



Cod. europeo	Cod. fabbrica	Tipo	Dimensioni	Conf. (pz)	Imballo (conf)	Pallet (conf)	€/conf
9901-2900-10	260010	DIMA	500 - 900 mm	-	10	600	57,320
9901-2900-15	260015	DIMA 140	800 - 1450 mm	-	1	-	91,140
9901-2900-16	260016	DIMA 260	1400 - 2600 mm	-	1	-	126,700
9901-2900-30	260030	KIT DIMA	500 - 900 mm	-	5	125	136,900

**SIMPLIFY  
YOUR  
WORK**

## 2.

# FISSAGGI SANITARI

La famiglia di fissaggi per sanitari di GIA è tra le più storiche dell'azienda. La gamma comprende soluzioni per il fissaggio su muratura di sanitari a terra, supporti laterali, lavabi, lavelli, scaldabagni e caldaie, tutti dotati di ancoranti professionali dimensionati per stabilità e durata.

Per i sanitari sospesi, la gamma prevede staffe dedicate a vasi e bidet, studiate per resistenza e semplicità di installazione. Per le pareti in cartongesso, GIA ha sviluppato una proposta completa con telai, staffe regolabili e sistemi modulari, pensati per semplificare il lavoro dell'installatore garantendo robustezza, compatibilità con gli spessori di lastra e integrazione con impianti idraulici.

SCOPRI DI PIÙ,  
INQUADRA IL  
QR CODE



## Staffe per sanitari sospesi su muratura



ROSSA

staffa premontata  
per vasi sospesi



BIANCA

staffa premontata  
per vasi e bidet sospesi

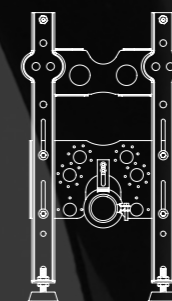

AZZURRA

staffa premontata  
per bidet sospesi

## Staffe per sanitari sospesi su cartongesso

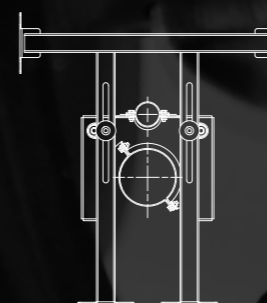

TDW

telaio autoportante  
per vasi sospesi

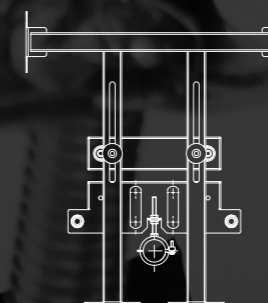

TDB

telaio autoportante  
per bidet sospesi

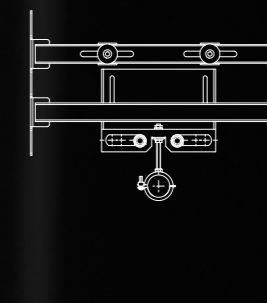

TDL

telaio autoportante  
per lavabi sospesi

# FISSAGGI PER SANITARI PER MURATURA

## WB INOX

Kit di fissaggio a pavimento di vasi e bidet con ancorante Giolli in buste trasparenti



Cod. europeo	Cod. fabbrica	Tipo	Descrizione	Conf. (pz)	Imballo (conf)	Pallet (conf)	€/conf
9902-0104-00	020400	WB INOX	M6x80 - Giolli Ø8	4	100	2700	5,420
9902-0104-10	020410	WBL INOX	M6x100 - Giolli Ø8	4	100	2700	7,650

## WB/WBL TECH INOX

Kit di fissaggio a pavimento di vasi e bidet con ancorante G-TECH in buste trasparenti



Cod. europeo	Cod. fabbrica	Tipo	Descrizione	Conf. (pz)	Imballo (conf)	Pallet (conf)	€/conf
9902-0104-05	020405	WB TECH INOX	M6x80 - G-Tech Ø8	4	100	2700	5,260
9902-0104-15	020415	WBL TECH INOX	M6x100 - G-Tech Ø8	4	25	3000	7,430

## WB 2 INOX

Supporti laterali per il fissaggio a pavimento di vasi e bidet in buste trasparenti da 2 pz/cad



Cod. europeo	Cod. fabbrica	Tipo	Ancorante	Conf. (pz)	Imballo (conf)	Pallet (conf)	€/conf
9902-0102-01	020201	WB 2 INOX	Giolli Ø8	2	50	1350	8,200

## WB 2 TECH INOX

Supporti laterali per il fissaggio a pavimento di vasi e bidet in buste trasparenti da 2 pz/cad



Cod. europeo	Cod. fabbrica	Tipo	Ancorante	Conf. (pz)	Imballo (conf)	Pallet (conf)	€/conf
9902-0102-05	020205	WB 2 TECH INOX	G-Tech Ø8	2	50	1350	7,960

## CP

Fissaggio cassette di scarico a muro in buste trasparenti da 2 pz/cad

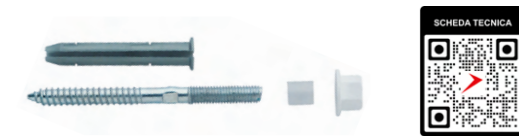

Cod. europeo	Cod. fabbrica	Tipo	Descrizione	Conf. (pz)	Imballo (conf)	Pallet (conf)	€/conf
9902-0519-00	031900	CP	M8x100 - Giolli Ø10	2	100	2700	4,690

## LR

Fissaggio regolabile lavabi a muro in buste trasparenti da 2 pz/cad



Cod. europeo	Cod. fabbrica	Tipo	Descrizione	Conf. (pz)	Imballo (conf)	Pallet (conf)	€/conf
9902-0302-00	030200	LR 3	M10x120 - Giolli Ø12	2	80	2160	3,830
9902-0303-00	030300	LR 4	M10x180 - Giolli Ø12	2	50	1350	7,140
9902-0304-00	030400	LR 5	M10x220 - Giolli Ø12	2	50	1350	8,730

## LR 14

Fissaggio lavabo a muro in buste trasparenti da 2 pz/cad



Cod. europeo	Cod. fabbrica	Tipo	Descrizione	Conf. (pz)	Imballo (conf)	Pallet (conf)	€/conf
9902-0302-05	030205	LR 14	M10x130 - Foro Ø14	2	50	1350	5,270

## LC - LA

Supporti regolabili per il fissaggio a muro di lavelli in buste trasparenti da 2 pz/cad



Cod. europeo	Cod. fabbrica	Tipo	Dimensioni	Conf. (pz)	Imballo (conf)	Pallet (conf)	€/conf
9902-0310-02	021000	LC	11x460 mm	2	15	360	38,490
9902-0320-00	022000	LA	11x340 mm	2	15	405	35,820

## BL 2

Fissaggi a muro di scaldabagni e caldaie in buste trasparenti da 2 pz/cad



Cod. europeo	Cod. fabbrica	Tipo	Descrizione	Conf. (pz)	Imballo (conf)	Pallet (conf)	€/conf
9902-0521-50	032150	BL2	10x95 - Giolli Ø8	2	100	2700	2,580

## BLR

Fissaggi a muro regolabile di scaldabagni e caldaie in buste trasparenti da 2 pz/cad



Cod. europeo	Cod. fabbrica	Tipo	Descrizione	Conf. (pz)	Imballo (conf)	Pallet (conf)	€/conf
9902-0522-00	032200	BLR	10x83 - Giolli Ø12	2	80	2160	8,680

## BL 14

Fissaggi a muro di scaldabagni e caldaie in buste trasparenti da 2 pz/cad



Cod. europeo	Cod. fabbrica	Tipo	Descrizione	Conf. (pz)	Imballo (conf)	Pallet (conf)	€/conf
9902-0521-55	032155	BL 14	10x93 - Foro Ø14	2	50	2800	4,370

## G80

Staffa universale per vasi sospesi con supporto per cassette a incasso in scatola - Articolo in esaurimento



Cod. europeo	Cod. fabbrica	Tipo	Conf. (pz)	Imballo (conf)	Pallet (conf)	€/conf
9902-1106-00	020600	G80	-	1	-	59,930

## SVELTA EVO

Staffa universale per vasi e bidet sospesi in scatola



Cod. europeo	Cod. fabbrica	Tipo	Descrizione	Conf. (pz)	Imballo (pz)	Pallet (pz)	€/pz
9902-1105-33	020533	SVELTA EVO 180	Staffa montata a 180 mm	-	5	75	35,030
9902-1105-37	020537	SVELTA EVO	Staffa singola in scatola	-	1	70	34,660

## BIANCA

Staffa premontata universale per vasi e bidet sospesi in scatola



Cod. europeo	Cod. fabbrica	Tipo	Descrizione	Conf. (pz)	Imballo (pz)	Pallet (pz)	€/pz
9902-1105-15	020515	BIANCA	Con istruzioni	-	1	60	61,280

## ROSSA

Staffa premontata universale per vasi sospesi in scatola



Cod. europeo	Cod. fabbrica	Tipo	Descrizione	Conf. (pz)	Imballo (pz)	Pallet (pz)	€/pz
9902-1105-02	020502	ROSSA	Con istruzioni	-	1	60	54,100

## AZZURRA

Staffa premontata universale per bidet sospesi in scatola



Cod. europeo	Cod. fabbrica	Tipo	Descrizione	Conf. (pz)	Imballo (pz)	Pallet (pz)	€/pz
9902-1105-13	020513	AZZURRA	Con istruzioni	-	1	60	71,470

## SIN 180-230

Kit doppio interasse per staffe rossa, azzurra e bianca in buste trasparenti



Cod. europeo	Cod. fabbrica	Tipo	Conf. (pz)	Imballo (conf)	Pallet (conf)	€/conf
9902-1205-07	020507	SIN 180 - 230	2	10	1200	21,100

## PRO

Prolunga per staffe rossa, azzurra e bianca in buste trasparenti



Cod. europeo	Cod. fabbrica	Tipo	Conf. (pz)	Imballo (conf)	Pallet (conf)	€/conf
9902-1205-50	020550	PRO	2	4	480	20,230

## PSS

Piedino di rinforzo per staffe rossa, azzurra e bianca in buste trasparenti



Cod. europeo	Cod. fabbrica	Tipo	Conf. (pz)	Imballo (conf)	Pallet (conf)	€/conf
9902-1205-20	020520	PSS	2	8	216	24,550

## SAP

Sagoma universale protettiva per appoggio vasi e bidet in buste trasparenti



Cod. europeo	Cod. fabbrica	Tipo	Conf. (pz)	Imballo (pz)	Pallet (pz)	€/pz
9902-1205-08	020508	SAP	1	25	750	18,190

## SIP

Striscia protettiva per appoggio sanitari e ceramiche in genere in buste trasparenti



Cod. europeo	Cod. fabbrica	Tipo	Dimensioni	Conf. (pz)	Imballo (pz)	Pallet (pz)	€/pz
9902-1205-09	020509	SIP	5 mt	1	8	448	16,130

## CAP

Kit di fissaggio alle staffe per sanitari sospesi in buste trasparenti



Cod. europeo	Cod. fabbrica	Tipo	Conf. (pz)	Imballo (conf)	Pallet (conf)	€/conf
9902-1205-05	020505	CAP	2	10	1200	8,290

## PO

Kit prolunghe in ottone 1/2" in buste trasparenti



Cod. europeo	Cod. fabbrica	Tipo	Conf. (pz)	Imballo (conf)	Pallet (conf)	€/conf
9902-1205-06	020506	PO	2	20	2400	24,950

# FISSAGGI PER SANITARI PER CARTONGESSO

## TDW

Telaio autoportante vaso sospeso per cartongesso



Cod. europeo	Cod. fabbrica	Tipo	Dimensioni (mm)	Conf. (pz)	Imballo (pz)	Pallet (pz)	€/pz
9902-1507-00	020700	TDW	Larghezza 530/550	-	1	-	219,100
9902-1507-01	020701	TDW200	Lunghezza extra H+200	-	1	-	271,500

## TDCS

Supporto cassetta di scarico per cartongesso



Cod. europeo	Cod. fabbrica	Tipo	Dimensioni (mm)	Conf. (pz)	Imballo (pz)	Pallet (pz)	€/pz
9902-1507-29	020729	TDCS	Larghezza 530/550	-	1	-	37,290

### NOTE PER L'INSTALLAZIONE

CASO 1 - VASO SOSPESO: l'articolo va abbinato al telaio TDW (cod. 020700)  
CASO 2 - VASO A PAVIMENTO FILO PARETE: l'articolo è da abbinare a TDWP (cod. 020705)  
in caso di scarico a parete, oppure a TDWP1 (cod. 020706) in caso di scarico a terra.

## TDWH

Telaio autoportante vaso sospeso disabili per cartongesso



Cod. europeo	Cod. fabbrica	Tipo	Dimensioni (mm)	Conf. (pz)	Imballo (pz)	Pallet (pz)	€/pz
9902-1507-08	020708	TDWH	Larghezza 530/550	-	1	-	329,000

## TDB

Telaio autoportante bidet sospeso per cartongesso



Cod. europeo	Cod. fabbrica	Tipo	Dimensioni (mm)	Conf. (pz)	Imballo (pz)	Pallet (pz)	€/pz
9902-1507-10	020710	TDB	Larghezza 530/550	-	1	-	226,700
9902-1507-11	020711	TDB 200	Lunghezza extra H+200	-	1	-	279,200

## TDO

Telaio orinatoio sospeso per cartongesso



Cod. europeo	Cod. fabbrica	Tipo	Dimensioni (mm)	Conf. (pz)	Imballo (pz)	Pallet (pz)	€/pz
9902-1507-40	020740	TDO	Larghezza 530/550	-	1	-	321,400

## TDL

Telaio lavabo sospeso per cartongesso



Cod. europeo	Cod. fabbrica	Tipo	Dimensioni (mm)	Conf. (pz)	Imballo (pz)	Pallet (pz)	€/pz
9902-1507-20	020720	TDL	Larghezza 530/550	-	1	-	167,500

## TDLC

Telaio lavabo a canale per cartongesso



Cod. europeo	Cod. fabbrica	Tipo	Dimensioni (mm)	Conf. (pz)	Imballo (pz)	Pallet (pz)	€/pz
9902-1507-22	020722	TDLC	Larghezza 530/550 Lung. mensola 350	-	1	-	239,300

## TDLH

Telaio lavabo sospeso per disabili per cartongesso

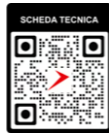

Cod. europeo	Cod. fabbrica	Tipo	Dimensioni (mm)	Conf. (pz)	Imballo (pz)	Pallet (pz)	€/pz
9902-1507-28	020728	TDLH	Larghezza 530/550	-	1	-	334,200

## TDWP

Telaio vaso a pavimento per cartongesso



Cod. europeo	Cod. fabbrica	Tipo	Dimensioni (mm)	Conf. (pz)	Imballo (pz)	Pallet (pz)	€/pz
9902-1507-05	020705	TDWP	Larghezza 530/550	-	1	-	101,000

## TDWP1

Telaio vaso a pavimento senza scarico per cartongesso



Cod. europeo	Cod. fabbrica	Tipo	Dimensioni (mm)	Conf. (pz)	Imballo (pz)	Pallet (pz)	€/pz
9902-1507-06	020706	TDWP1	Larghezza 530/550	-	1	-	74,910

## TDML

Telaio mensola porta lavabo per cartongesso



Cod. europeo	Cod. fabbrica	Tipo	Dimensioni (mm)	Conf. (pz)	Imballo (pz)	Pallet (pz)	€/pz
9902-1507-23	020723	TDML	Largh. 530/550 - Lung. mens. 350 + prolunga fino a 600	-	1	-	363,100

## TDS

Telaio soffione doccia per cartongesso



Cod. europeo	Cod. fabbrica	Tipo	Dimensioni (mm)	Conf. (pz)	Imballo (pz)	Pallet (pz)	€/pz
9902-1507-34	020734	TDS	Larghezza 530/550	-	1	-	83,850

## TDM1

Telaio miscelatore interno per cartongesso



Cod. europeo	Cod. fabbrica	Tipo	Dimensioni (mm)	Conf. (pz)	Imballo (pz)	Pallet (pz)	€/pz
9902-1507-35	020735	TDM1	Larghezza 530/550	-	1	-	83,850

## TDM2

Telaio miscelatore esterno per cartongesso



Cod. europeo	Cod. fabbrica	Tipo	Dimensioni (mm)	Conf. (pz)	Imballo (pz)	Pallet (pz)	€/pz
9902-1507-36	020736	TDM2	Larghezza 530/550	-	1	-	83,850

## TDU

Telaio supporto universale per cartongesso



Cod. europeo	Cod. fabbrica	Tipo	Dimensioni (mm)	Conf. (pz)	Imballo (pz)	Pallet (pz)	€/pz
9902-1507-33	020733	TDU	Legno 520x220x20	-	1	-	114,900
9902-1507-41	9902-1507-41	TDU H 360	Legno 520x360x20	-	1	-	126,00

## TDU H 520

Telaio supporto universale verticale per cartongesso



Cod. europeo	Cod. fabbrica	Tipo	Dimensioni (mm)	Conf. (pz)	Imballo (pz)	Pallet (pz)	€/pz
9902-1507-42	9902-1507-42	TDU H520	Legno 220x520x20	-	1	-	139,00

## TDT

Traversa universale per cartongesso



Cod. europeo	Cod. fabbrica	Tipo	Dimensioni (mm)	Conf. (pz)	Imballo (pz)	Pallet (pz)	€/pz
9902-1507-31	020731	TDT	Larghezza 530/550	-	1	-	57,840

## TDLA

Telaio lavatrice/lavastoviglie per cartongesso



Cod. europeo	Cod. fabbrica	Tipo	Dimensioni (mm)	Conf. (pz)	Imballo (pz)	Pallet (pz)	€/pz
9902-1507-37	020737	TDLA	Larghezza 530/550	-	1	-	100,900

## TDRA

Telaio rubinetti d'arresto per cartongesso



Cod. europeo	Cod. fabbrica	Tipo	Dimensioni (mm)	Conf. (pz)	Imballo (pz)	Pallet (pz)	€/pz
9902-1507-38	020738	TDRA	Larghezza 530/550	-	1	-	91,660

## TDBP

Telaio bidet a pavimento per cartongesso



Cod. europeo	Cod. fabbrica	Tipo	Dimensioni (mm)	Conf. (pz)	Imballo (pz)	Pallet (pz)	€/pz
9902-1507-15	020715	TDBP	Larghezza 530/550 anche sottolavello	-	1	-	83,850

## TDSRA/TDIRA

Staffa a "Z" per cartongesso



TDSRA

TDIRA



Cod. europeo	Cod. fabbrica	Tipo	Dimensioni (mm)	Conf. (pz)	Imballo (pz)	Pallet (pz)	€/pz
9902-1507-39	020739	TDSRA	Raccordo M/F 1/2"	-	1	-	33,440
9902-1507-32	020732	TDIRA	Raccordo M/F 1/2" - int.	-	1	-	32,790

## SNELLA L

Telaio per lavabo per cartongesso in scatola



Cod. europeo	Cod. fabbrica	Tipo	Dimensioni (mm)	Conf. (pz)	Imballo (pz)	Pallet (pz)	€/pz
9902-1508-20	9795-151-700	SNELLA L	H 980 - L 580 Interasse 122/130	-	1	50	151,500

## SNELLA W

Telaio per vaso per cartongesso in scatola



Cod. europeo	Cod. fabbrica	Tipo	Dimensioni (mm)	Conf. (pz)	Imballo (pz)	Pallet (pz)	€/pz
9902-1508-01	9795-131-700	SNELLA W	H 980 - L 580 Interasse 180/230	-	1	50	154,400

## SNELLA B

Telaio per bidet per cartongesso in scatola



Cod. europeo	Cod. fabbrica	Tipo	Dimensioni (mm)	Conf. (pz)	Imballo (pz)	Pallet (pz)	€/pz
9902-1508-10	9795-141-700	SNELLA B	H 980 - L 450 Interasse 180/230	-	1	50	150,900

**SIMPLIFY  
YOUR  
WORK**

### 3. COLLARI E FISSAGGI PER TUBAZIONI

La gamma di collari e supporti per tubazioni di GIA è vasta e in continuo sviluppo. Include collari in acciaio zincato, modelli ad incastro per profilati, soluzioni per impianti sprinkler anche in versione antisismica, collari rivestiti in EPDM o silicone per alte temperature, prodotti insonorizzati e collari per tubazioni in rame.

Punto di forza sono i collari in PA 6.6, con tecnologia bi-materiale e guaina in EPDM, disponibili in tre colori per una migliore resa estetica. A completare la gamma, piattelli, riduzioni e accessori, studiati per ogni tipologia di applicazione installativa.

SCOPRI DI PIÙ,  
INQUADRA IL  
QR CODE



## FLIP SYSTEM



FLIP  
Collare a serraggio rapido

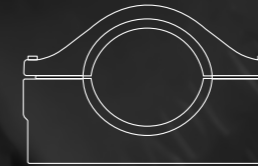

FLIP R  
Collare a serraggio rapido ribassato

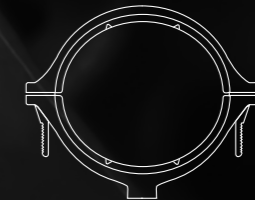

FLIP S  
Collare a serraggio rapido super isofonico

## Caratteristiche tecniche

Realizzati in Nylon PA 6.6 resistente ai raggi UV, alla corrosione e alla nebbia salina, con guaina isofonica in EPDM e inserto filettato in ottone.

Sistema di collari ideale per il fissaggio di tubazioni in impianti idrotermosanitari, pluviali, canalizzazioni elettriche, adatto sia all'uso interno che esterno.

Serraggio regolabile grazie alle linguette dentate laterali, ideale per la creazione sia di punti fissi sia di punti scorrevoli in uno stesso impianto, a seconda delle esigenze di installazione.

Rapida installazione: una volta fissata la base a muro mediante vite e ancorante, il collare si chiude con la semplice pressione delle dita, senza l'utilizzo di utensili.

Se necessario, è inoltre possibile riaprire il collare altrettanto semplicemente usando l'apposito attrezzo APRIFLIP. Basta inserirne i perni negli appositi fori a vista fino a fine corsa e tirare: la parte mobile si libera e il tubo può essere rimosso.

In alternativa, con la stessa tecnica di estrazione, si possono usare due cacciaviti a croce con Ø 3 mm.

## FLIP

Collare a serraggio rapido con fissaggio in buste trasparenti



Cod. europeo	Cod. fabbrica	Tipo	Descrizione	Conf. (pz)	Imballo (pz)	Pallet (pz)	€/pz
9908-7000-05	180005	FLIP 3/8" 14-18	M8 - Giolli Ø10	2	100	2700	3,230
9908-7000-10	180010	FLIP 1/2" 20-24	M8 - Giolli Ø10	2	100	2700	3,390
9908-7000-15	180015	FLIP 3/4" 25-30	M8 - Giolli Ø10	2	60	1620	3,520
9908-7000-20	180020	FLIP 1" 32-36	M8 - Giolli Ø10	2	60	1620	3,770
9908-7000-25	180025	FLIP 1 1/4" 38-44	M8 - Giolli Ø10	2	50	1350	4,120
9908-7000-30	180030	FLIP 1 1/2" 44-50	M8/M10 - Giolli Ø10	2	50	1350	5,190
9908-7000-35	180035	FLIP 2" 56-63	M8/M10 - Giolli Ø10	2	40	1080	5,490
9908-7000-40	180040	FLIP 2 1/2" 74-80	M8/M10 - Giolli Ø10	2	30	810	6,640
9908-7000-45	180045	FLIP 3" 84-90	M8/M10 - Giolli Ø10	2	20	540	7,290

## FLIP1

Collare a serraggio rapido in buste trasparenti



Cod. europeo	Cod. fabbrica	Tipo	Descrizione	Conf. (pz)	Imballo (pz)	Pallet (pz)	€/pz
9999-1801-05	180105	FLIP1 3/8" 14-18	M8	2	100	2700	2,890
9999-1801-10	180110	FLIP1 1/2" 20-24	M8	2	100	2700	3,010
9999-1801-15	180115	FLIP1 3/4" 25-30	M8	2	60	1620	3,160
9999-1801-20	180120	FLIP1 1" 32-36	M8	2	60	1620	3,440
9999-1801-25	180125	FLIP1 1 1/4" 38-44	M8	2	50	1350	3,750
9999-1801-30	180130	FLIP1 1 1/2" 44-50	M8/M10	2	50	1350	4,780
9999-1801-35	180135	FLIP1 2" 56-63	M8/M10	2	40	1080	5,170
9999-1801-40	180140	FLIP1 2 1/2" 74-80	M8/M10	2	30	810	6,310
9999-1801-45	180145	FLIP1 3" 84-90	M8/M10	2	20	540	6,990

## FLIP1 G

Collare a serraggio rapido GIALLO in buste trasparenti



Cod. europeo	Cod. fabbrica	Tipo	Descrizione	Conf. (pz)	Imballo (pz)	Pallet (pz)	€/pz
9908-7102-05	180205	FLIP1G 3/8" 14-18	M8 Giallo	2	40	2240	3,200
9908-7102-10	180210	FLIP1G 1/2" 20-24	M8 Giallo	2	40	2240	3,390
9908-7102-15	180215	FLIP1G 3/4" 25-30	M8 Giallo	2	30	1680	3,530
9908-7102-20	180220	FLIP1G 1" 32-36	M8 Giallo	2	30	1680	3,860
9908-7102-25	180225	FLIP1G 1 1/4" 38-44	M8 Giallo	2	20	1120	4,210
9908-7102-30	180230	FLIP1G 1 1/2" 44-50	M8/M10 Giallo	2	20	1120	5,400
9908-7102-35	180235	FLIP1G 2" 56-63	M8/M10 Giallo	2	20	1120	5,790

## FLIP1 M

Collare a serraggio rapido MARRONE in buste trasparenti



Cod. europeo	Cod. fabbrica	Tipo	Descrizione	Conf. (pz)	Imballo (pz)	Pallet (pz)	€/pz
9908-7103-05	180305	FLIP1M 3/8" 14-18	M8 Marrone	2	40	2240	3,200
9908-7103-10	180310	FLIP1M 1/2" 20-24	M8 Marrone	2	40	2240	3,390
9908-7103-15	180315	FLIP1M 3/4" 25-30	M8 Marrone	2	30	1680	3,530
9908-7103-20	180320	FLIP1M 1" 32-36	M8 Marrone	2	30	1680	3,860
9908-7103-25	180325	FLIP1M 1 1/4" 38-44	M8 Marrone	2	20	1120	4,210
9908-7103-30	180330	FLIP1M 1 1/2" 44-50	M8/M10 Marrone	2	20	1120	5,400
9908-7103-35	180335	FLIP1M 2" 56-63	M8/M10 Marrone	2	20	1120	5,790
9908-7103-40	180340	FLIP1M 2 1/2" 74-80	M8/ M10 Marrone	2	10	560	7,100

## FLIP RW

Collare ribassato a serraggio rapido con fissaggio in buste trasparenti



Cod. europeo	Cod. fabbrica	Tipo	Descrizione	Conf. (pz)	Imballo (pz)	Pallet (pz)	€/pz
9908-7207-05	180705	FLIP RW 3/8" 14-18	6x70 TNY Ø10	2	100	2700	2,260
9908-7207-10	180710	FLIP RW 1/2" 20-24	6x70 TNY Ø10	2	100	2700	2,310
9908-7207-15	180715	FLIP RW 3/4" 25-30	6x70 TNY Ø10	2	60	1620	2,390
9908-7207-20	180720	FLIP RW 1" 32-36	6x70 TNY Ø10	2	60	1620	2,760
9908-7207-25	180725	FLIP RW 1 1/4" 38-44	6x70 TNY Ø10	2	50	1350	3,090
9908-7207-30	180730	FLIP RW 1 1/2" 44-50	6x70 TNY Ø10	2	50	1350	3,640
9908-7207-35	180735	FLIP RW 2" 56-63	6x70 TNY Ø10	2	40	1080	4,180
9908-7207-40	180740	FLIP RW 2 1/2" 74-80	6x70 TNY Ø10	2	30	810	5,480
9908-7207-45	180745	FLIP RW 3" 84-90	6x70 TNY Ø10	2	20	540	6,000

## FLIP R

Collare ribassato a serraggio rapido in buste trasparenti



Cod. europeo	Cod. fabbrica	Tipo	Descrizione	Conf. (pz)	Imballo (pz)	Pallet (pz)	€/pz
9999-1804-05	180405	FLIP R 3/8" 14-18	Vite Ø 6 - Grigio	2	100	2700	1,840
9999-1804-10	180410	FLIP R 1/2" 20-24	Vite Ø 6 - Grigio	2	100	2700	1,900
9999-1804-15	180415	FLIP R 3/4" 25-30	Vite Ø 6 - Grigio	2	60	1620	1,990
9999-1804-20	180420	FLIP R 1" 32-36	Vite Ø 6 - Grigio	2	60	1620	2,350
9999-1804-25	180425	FLIP R 1 1/4" 38-44	Vite Ø 6 - Grigio	2	50	1350	2,650
9999-1804-30	180430	FLIP R 1 1/2" 44-50	Vite Ø 6 - Grigio	2	50	1350	3,230
9999-1804-35	180435	FLIP R 2" 56-63	Vite Ø 6 - Grigio	2	40	1080	3,750
9999-1804-40	180440	FLIP R 2 1/2" 74-80	Vite Ø 6 - Grigio	2	30	810	5,070
9999-1804-45	180445	FLIP R 3" 84-90	Vite Ø 6 - Grigio	2	20	540	5,560

## FLIP RG

Collare ribassato a serraggio rapido GIALLO in buste trasparenti



Cod. europeo	Cod. fabbrica	Tipo	Descrizione	Conf. (pz)	Imballo (pz)	Pallet (pz)	€/pz
9908-7305-05	180505	FLIP RG 3/8" 14-18	Vite Ø 6 - Giallo	2	40	2240	2,060
9908-7305-10	180510	FLIP RG 1/2" 20-24	Vite Ø 6 - Giallo	2	40	2240	2,130
9908-7305-15	180515	FLIP RG 3/4" 25-30	Vite Ø 6 - Giallo	2	30	1680	2,180
9908-7305-20	180520	FLIP RG 1" 32-36	Vite Ø 6 - Giallo	2	30	1680	2,620
9908-7305-25	180525	FLIP RG 1 1/4" 38-44	Vite Ø 6 - Giallo	2	20	1120	3,000
9908-7305-30	180530	FLIP RG 1 1/2" 44-50	Vite Ø 6 - Giallo	2	20	1120	3,630
9908-7305-35	180535	FLIP RG 2" 56-63	Vite Ø 6 - Giallo	2	20	1120	4,210

## FLIP RM

Collare ribassato a serraggio rapido MARRONE in buste trasparenti



Cod. europeo	Cod. fabbrica	Tipo	Descrizione	Conf. (pz)	Imballo (pz)	Pallet (pz)	€/pz
9908-7306-05	180605	FLIP RM 3/8" 14-18	Vite Ø 6 - Marrone	2	40	2240	2,060
9908-7306-10	180610	FLIP RM 1/2" 20-24	Vite Ø 6 - Marrone	2	40	2240	2,130
9908-7306-15	180615	FLIP RM 3/4" 25-30	Vite Ø 6 - Marrone	2	30	1680	2,180
9908-7306-20	180620	FLIP RM 1" 32-36	Vite Ø 6 - Marrone	2	30	1680	2,620
9908-7306-25	180625	FLIP RM 1 1/4" 38-44	Vite Ø 6 - Marrone	2	20	1120	3,000
9908-7306-30	180630	FLIP RM 1 1/2" 44-50	Vite Ø 6 - Marrone	2	20	1120	3,630
9908-7306-35	180635	FLIP RM 2" 56-63	Vite Ø 6 - Marrone	2	20	1120	4,210
9908-7306-40	180640	FLIP RM 2 1/2" 74-80	Vite Ø 6 - Marrone	2	10	560	5,700

## FLIP SI

Collare a serraggio rapido super isofonico in buste trasparenti



Cod. europeo	Cod. fabbrica	Tipo	Descrizione	Conf. (pz)	Imballo (pz)	Pallet (pz)	€/pz
9999-1808-45	180845	FLIP SI 90 (84-90)	M8/M10	1	20	540	6,600
9999-1808-50	180850	FLIP SI 110 (100-110)	M10	1	15	405	9,020
9999-1808-55	180855	FLIP SI 125 (125-135)	M10	1	15	405	9,670

## FLIP SI M

Collare a serraggio rapido super isofonico MARRONE in buste trasparenti



Cod. europeo	Cod. fabbrica	Tipo	Descrizione	Conf. (pz)	Imballo (pz)	Pallet (pz)	€/pz
9908-7409-45	180945	FLIP SIM 90 (84-90)	M8/M10 Marrone	1	20	540	8,300
9908-7409-50	180950	FLIP SIM 110 (100-110)	M10 Marrone	1	15	405	11,440
9908-7409-55	180955	FLIP SIM 125 (125-135)	M10 Marrone	1	15	405	12,160

## FX

Flangia universale in scatola



Cod. europeo	Cod. fabbrica	Tipo	Descrizione	Conf. (pz)	Imballo (pz)	Pallet (pz)	€/pz
9908-7510-50	181050	FX 8	M8	-	30	5400	4,910
9908-7510-55	181055	FX 10	M10	-	30	5400	4,910

## BLOC

Kit autobloccante FLIP-R in buste trasparenti

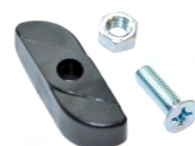

Cod. europeo	Cod. fabbrica	Tipo	Descrizione	Conf. (pz)	Imballo (pz)	Pallet (pz)	€/pz
9908-7510-60	181060	BLOC	Per FLIP R	1	30	3600	1,330

## TNY 10

Ancorante TNY e vite in buste trasparenti

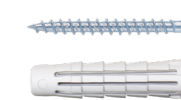

Cod. europeo	Cod. fabbrica	Tipo	Descrizione	Conf. (pz)	Imballo (pz)	Pallet (pz)	€/pz
9908-7510-70	181070	TNY 10	Vite 6x70 - Ancorante TNY Ø10	10	200	24000	0,620

## APRIFLIP

Utensile apri-collare in scatola



Cod. europeo	Cod. fabbrica	Tipo	Conf. (pz)	Imballo (pz)	Pallet (pz)	€/pz
9999-1811-00	181100	AFLIP	1	10	3360	7,740

## STO

Coppia di collari pesanti con fissaggio e vite a martello in buste trasparenti da 2 pz/cad.

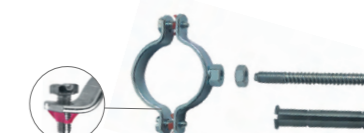

Cod. europeo	Cod. fabbrica	Tipo	Descrizione	Conf. (cp)	Imballo (cp)	Pallet (cp)	€/coppia
9908-1100-03	080003	STO 3/8"	M8 - Giolli Ø10	1	80	2160	3,960
9908-1101-03	080103	STO 1/2"	M8 - Giolli Ø10	1	80	2160	3,990
9908-1102-03	080203	STO 3/4"	M8 - Giolli Ø10	1	60	1620	4,310
9908-1103-03	080303	STO 1"	M8 - Giolli Ø10	1	60	1620	4,600
9908-1104-03	080403	STO 1 1/4"	M8 - Giolli Ø10	1	60	1620	5,010
9908-1105-03	080503	STO 1 1/2"	M8 - Giolli Ø10	1	50	1350	5,230
9908-1106-03	080603	STO 2"	M8 - Giolli Ø10	1	50	1350	5,760
9908-1107-03	080703	STO 2 1/2"	M10 - Giolli Ø12	1	25	675	10,810
9908-1108-03	080803	STO 3"	M10 - Giolli Ø12	1	25	675	11,620
9908-1108-53	080853	STO 3 1/2"	M10 - Giolli Ø12	1	25	675	12,410
9908-1109-03	080903	STO 4"	M10 - Giolli Ø12	1	20	540	12,990

## STO TN

Collare pesante con fissaggio universale  
in buste trasparenti



Cod. europeo	Cod. fabbrica	Tipo	Descrizione	Conf. (pz)	Imballo (pz)	Pallet (pz)	€/pz
9908-1300-04	080004	STO TN 3/8"	M8 - G-Tech Ø10	2	160	4320	1,710
9908-1301-04	080104	STO TN 1/2"	M8 - G-Tech Ø10	2	160	4320	1,720
9908-1302-04	080204	STO TN 3/4"	M8 - G-Tech Ø10	2	120	3240	1,870
9908-1303-04	080304	STO TN 1"	M8 - G-Tech Ø10	2	120	3240	1,990
9908-1304-04	080404	STO TN 1 1/4"	M8 - G-Tech Ø10	2	120	3240	2,160
9908-1305-04	080504	STO TN 1 1/2"	M8 - G-Tech Ø10	2	100	2700	2,260
9908-1306-04	080604	STO TN 2"	M8 - G-Tech Ø10	2	100	2700	2,490
9908-1307-04	080704	STO TN 2 1/2"	M10 - G-Tech Ø12	2	50	1350	4,680
9908-1308-04	080804	STO TN 3"	M10 - G-Tech Ø12	2	50	1350	5,020
9908-1309-04	080904	STO TN 4"	M10 - G-Tech Ø12	2	40	1080	5,620

## STO 1

Coppia di collari pesanti  
in buste trasparenti



Cod. europeo	Cod. fabbrica	Tipo	Descrizione	Conf. (cp)	Imballo (cp)	Pallet (cp)	€/coppia
9908-1220-00	082000	STO1 3/8"	M8 - Per tubi Ø17-19	1	80	2160	2,620
9908-1221-00	082100	STO1 1/2"	M8 - Per tubi Ø20-24	1	80	2160	2,640
9908-1222-00	082200	STO1 3/4"	M8 - Per tubi Ø26-29	1	80	2160	2,980
9908-1223-00	082300	STO1 1"	M8 - Per tubi Ø32-36	1	60	1620	3,260
9908-1224-00	082400	STO1 1 1/4"	M8 - Per tubi Ø40-44	1	60	1620	3,580
9908-1225-00	082500	STO1 1 1/2"	M8 - Per tubi Ø46-50	1	50	1350	3,800
9908-1225-50	082550	STO1 54	M8 - Per tubi Ø50-56	1	50	1350	4,290
9908-1226-00	082600	STO1 2"	M8 - Per tubi Ø58-61	1	50	1350	4,340
9908-1227-00	082700	STO1 2 1/2"	M10 - Per tubi Ø72-78	1	35	945	8,190
9908-1228-00	082800	STO1 3"	M10 - Per tubi Ø86-90	1	30	810	8,970
9908-1228-50	082850	STO1 3 1/2"	M10 - Per tubi Ø96-104	1	30	810	9,610
9908-1229-00	082900	STO1 4"	M10 - Per tubi Ø110-116	1	25	675	10,060
9908-1229-30*	082930	STO1 5"	1/2" - Per tubi Ø135-142	1	15	405	22,700
9908-1229-50*	082950	STO1 6"	1/2" - Per tubi Ø164-170	1	15	405	23,770
9908-1229-70*	082970	STO1 8"	1/2" - Per tubi Ø213-224	1	10	270	31,640
9908-1229-90*	082990	STO1 10"	1/2" - Per tubi Ø269-274	1	5	135	34,450

\* prezzo e confezione gestiti a pezzo



## CPF

Collare ad incastro per profili leggeri e medi  
in buste trasparenti



Cod. europeo	Cod. fabbrica	Tipo	Descrizione	Conf. (pz)	Imballo (pz)	Pallet (pz)	€/pz
9908-2730-00	083000	CPF 3/8"	M6x20 - Per tubi Ø17-18	1	100	5600	1,910
9908-2731-00	083100	CPF 1/2"	M6x20 - Per tubi Ø21-22	1	100	5600	1,950
9908-2732-00	083200	CPF 3/4"	M6x20 - Per tubi Ø26-28	1	100	5600	2,000
9908-2733-00	083300	CPF 1"	M6x20 - Per tubi Ø33-34	1	100	5600	2,050
9908-2734-00	083400	CPF 1 1/4"	M6x20 - Per tubi Ø42-43	1	100	2700	2,260
9908-2735-00	083500	CPF 1 1/2"	M8x25 - Per tubi Ø47-50	1	100	2700	2,940
9908-2736-00	083600	CPF 2"	M8x25 - Per tubi Ø60-63	1	90	2430	3,140
9908-2737-00	083700	CPF 2 1/2"	M8x25 - Per tubi Ø75-78	1	60	1620	3,910
9908-2738-00	083800	CPF 3"	M8x25 - Per tubi Ø88-90	1	60	1620	4,020
9908-2739-00	083900	CPF 4"	M8x25 - Per tubi Ø110-115	1	60	1620	4,430

## CPF3

Collare ad incastro per profili pesanti  
in scatola



Cod. europeo	Cod. fabbrica	Tipo	Descrizione	Conf. (pz)	Imballo (pz)	Pallet (pz)	€/pz
9908-2739-10	083910	CPF3 1/2"	M8x25 - Per tubi Ø22	1	20	6720	2,060
9908-2739-15	083915	CPF3 3/4"	M8x25 - Per tubi Ø28	1	20	6720	2,130
9908-2739-20	083920	CPF3 1"	M8x25 - Per tubi Ø35	1	20	6720	2,230
9908-2739-25	083925	CPF3 1 1/4"	M8x35 - Per tubi Ø44	1	20	3600	2,450
9908-2739-30	083930	CPF3 1 1/2"	M8x35 - Per tubi Ø50	1	20	3600	3,040
9908-2739-35	083935	CPF3 2"	M8x35 - Per tubi Ø62	1	20	3600	3,260
9908-2739-40	083940	CPF3 2 1/2"	M8x35 - Per tubi Ø78	1	20	2400	4,000
9908-2739-45	083945	CPF3 3"	M8x35 - Per tubi Ø90	1	20	2400	4,170
9908-2739-55	083955	CPF3 4"	M8x35 - Per tubi Ø116	1	20	2400	4,570
9908-2739-60	083960	CPF3 5"	M8x35 - Per tubi Ø141	1	20	1120	9,130



## CAV

Cavallotto ad "U"  
in scatola



Cod. europeo	Cod. fabbrica	Tipo	Descrizione	Conf. (pz)	Imballo (pz)	Pallet (pz)	€/pz
9908-2870-00	167000	CAV 3/8"	Ø 6 - Per tubi Ø17-18	-	100	12000	0,990
9908-2872-00	167200	CAV 1/2"	Ø 6 - Per tubi Ø21-22	-	100	12000	1,060
9908-2874-00	167400	CAV 3/4"	Ø 6 - Per tubi Ø26-28	-	100	12000	1,090
9908-2876-00	167600	CAV 1"	Ø 6 - Per tubi Ø33-34	-	100	12000	1,130
9908-2878-00	167800	CAV 1 1/4"	Ø 6 - Per tubi Ø42-43	-	100	12000	1,150
9908-2880-00	168000	CAV 1 1/2"	Ø 8 - Per tubi Ø47-50	-	80	9600	1,930
9908-2882-00	168200	CAV 2"	Ø 8 - Per tubi Ø60-63	-	50	6000	2,090
9908-2884-00	168400	CAV 2 1/2"	Ø 8 - Per tubi Ø75-78	-	50	6000	2,360
9908-2886-00	168600	CAV 3"	Ø 8 - Per tubi Ø88-90	-	30	3600	2,510
9908-2888-00	168800	CAV 3 1/2"	Ø 8 - Per tubi Ø100-102	-	30	3600	2,740
9908-2890-00	169000	CAV 4"	Ø 8 - Per tubi Ø110-115	-	30	3600	2,970
9908-2891-00	169100	CAV 5"	Ø 8 - Per tubi Ø135-140	-	30	1680	3,540
9908-2892-00	169200	CAV 6"	Ø 8 - Per tubi Ø163-168	-	30	1680	3,760
9908-2893-00	169300	CAV 8"	Ø 10 - Per tubi Ø215-220	-	20	540	13,620

## CSP

Collare per impianti antincendio SPRINKLER  
in scatola



Cod. europeo	Cod. fabbrica	Tipo	Descrizione	Conf. (pz)	Imballo (pz)	Pallet (pz)	€/pz
9908-3543-00	084300	CSP 1"	M10	-	50	6000	2,550
9908-3544-00	084400	CSP 1 1/4"	M10	-	50	2800	2,650
9908-3545-00	084500	CSP 1 1/2"	M10	-	50	2800	2,940
9908-3546-00	084600	CSP 2"	M10	-	50	2800	3,020
9908-3547-00	084700	CSP 2 1/2"	M10	-	50	1350	5,600
9908-3548-00	084800	CSP 3"	M10	-	25	1400	5,600
9908-3549-00	084900	CSP 4"	M10	-	25	675	7,150
9908-3549-30	084930	CSP 5"	M12	-	25	675	12,530
9908-3549-50	084950	CSP 6"	M12	-	25	675	13,350
9908-3549-70	084970	CSP 8"	M12	-	1*	-	20,800

\* confezionato sfuso



## CSPR

Collare antisismico di rinforzo laterale  
e longitudinale  
in scatola



Cod. europeo	Cod. fabbrica	Tipo	Descrizione	Conf. (pz)	Imballo (pz)	Pallet (pz)	€/pz
9908-3743-01	084301	CSPR 1"	Tubo DN 25	-	1	-	40,410
9908-3744-01	084401	CSPR 1 1/4"	Tubo DN 32	-	1	-	41,220
9908-3745-01	084501	CSPR 1 1/2"	Tubo DN 40	-	1	-	43,340
9908-3746-01	084601	CSPR 2"	Tubo DN 50	-	1	-	45,190
9908-3747-01	084701	CSPR 2 1/2"	Tubo DN 65	-	1	-	47,580
9908-3748-01	084801	CSPR 3"	Tubo DN 80	-	1	-	49,180
9908-3749-01	084901	CSPR 4"	Tubo DN 100	-	1	-	61,950
9908-3749-31	084931	CSPR 5"	Tubo DN 125	-	1	-	79,990
9908-3749-51	084951	CSPR 6"	Tubo DN 150	-	1	-	96,740
9908-3749-71	084971	CSPR 8"	Tubo DN 200	-	1	-	127,200

## STO1 G

Collare pesante con gomma EDPM  
in scatola



Cod. europeo	Cod. fabbrica	Tipo	Descrizione	Conf. (pz)	Imballo (pz)	Pallet (pz)	€/pz
9908-1620-09	082009	STO1 G 3/8"	M8 - Per tubi Ø12-18	-	100	5600	3,410
9908-1621-09	082109	STO1 G 1/2"	M8 - Per tubi Ø 19-23	-	100	5600	3,440
9908-1622-09	082209	STO1 G 3/4"	M8 - Per tubi Ø 25-30	-	100	5600	3,640
9908-1623-09	082309	STO1 G 1"	M8 - Per tubi Ø 33-38	-	100	2700	3,980
9908-1624-09	082409	STO1 G 1 1/4"	M8 - Per tubi Ø 39-44	-	100	2700	4,220
9908-1625-09	082509	STO1 G 1 1/2"	M8 - Per tubi Ø 45-49	-	60	1620	5,060
9908-1625-59	082559	STO1 G 54	M8 - Per tubi Ø 50-54	-	50	1350	5,130
9908-1626-09	082609	STO1 G 2"	M10 - Per tubi Ø 60-64	-	45	1215	7,780
9908-1627-09	082709	STO1 G 2 1/2"	M10 - Per tubi Ø 73-78	-	30	810	9,160
9908-1628-09	082809	STO1 G 3"	M10 - Per tubi Ø 85-90	-	30	810	9,890
9908-1628-59	082859	STO1 G 3 1/2"	M10 - Per tubi Ø97-102	-	30	810	10,940
9908-1629-09	082909	STO1 G 4"	M10 - Per tubi Ø110-116	-	15	405	12,540
9908-1629-39	082939	STO1 G 5"	1/2"- Per tubi Ø138-141	-	10	270	16,930
9908-1629-59	082959	STO1 G 6"	1/2"- Per tubi Ø165-169	-	10	270	18,940
9908-1629-69	082969	STO1 G 200	1/2"- Per tubi Ø200-205	-	5	135	52,630
9908-1629-79	082979	STO1 G 8"	1/2"- Per tubi Ø215-220	-	5	120	55,390
9908-1629-99	082999	STO1 G 10"	1/2"- Per tubi Ø269-274	-	5	120	61,200



3.

## STO1 GS

Collare pesante con gomma in silicone in scatola



Cod. europeo	Cod. fabbrica	Tipo	Descrizione	Conf. (pz)	Imballo (pz)	Pallet (pz)	€/pz
9908-1762-00	086200	STO1 GS 3/8"	M8 - Per tubi Ø12-18	-	25	3000	5,760
9908-1762-10	086210	STO1 GS 1/2"	M8 - Per tubi Ø 19-23	-	25	3000	5,880
9908-1762-20	086220	STO1 GS 3/4"	M8 - Per tubi Ø 25-30	-	25	3000	6,060
9908-1762-30	086230	STO1 GS 1"	M8 - Per tubi Ø 33-38	-	25	3000	6,790
9908-1762-40	086240	STO1 GS 1 1/4"	M8 - Per tubi Ø 39-44	-	25	3000	7,190
9908-1762-50	086250	STO1 GS 1 1/2"	M8 - Per tubi Ø 45-49	-	20	2400	8,960
9908-1762-55	086255	STO1 GS 54	M8 - Per tubi Ø 50-54	-	20	2400	9,220
9908-1762-60	086260	STO1 GS 2"	M10 - Per tubi Ø 60-64	-	20	1120	19,270
9908-1762-70	086270	STO1 GS 2 1/2"	M10 - Per tubi Ø 73-78	-	15	840	21,660
9908-1762-80	086280	STO1 GS 3"	M10 - Per tubi Ø 85-90	-	10	560	24,060
9908-1762-85	086285	STO1 GS 3 1/2"	M10 - Per tubi Ø97-102	-	10	560	27,450
9908-1762-90	086290	STO1 GS 4"	M10 - Per tubi Ø110-116	-	10	560	31,370
9908-1762-93	086293	STO1 GS 5"	1/2" - Per tubi Ø138-141	-	5	280	39,430
9908-1762-95	086295	STO1 GS 6"	1/2" - Per tubi Ø165-169	-	5	280	44,450

## SI

Collare a clip con EPDM per tubi di scarico insonorizzati in scatola



Cod. europeo	Cod. fabbrica	Tipo	Descrizione	Conf. (pz)	Imballo (pz)	Pallet (pz)	€/pz
9908-4570-75	087075	SI 75-78	Adattatore M10x1/2"	-	30	810	8,540
9908-4570-90	087090	SI 90	Adattatore M10x1/2"	-	30	810	9,310
9908-4571-10	087110	SI 110	Adattatore M10x1/2"	-	15	405	10,410
9908-4571-25	087125	SI 125	Adattatore M10x1/2"	-	15	405	11,170
9908-4571-35	087135	SI 135	Adattatore M10x1/2"	-	15	405	11,630
9908-4571-60	087160	SI 160	Adattatore M10x1/2"	-	10	270	12,900

## STP - G

Collare insonorizzato per tubi di scarico con attacco M10 in buste trasparenti



Cod. europeo	Cod. fabbrica	Tipo	Descrizione	Conf. (pz)	Imballo (pz)	Pallet (pz)	€/pz
9908-4353-09	085309	STP-G 75	M10	-	35	945	5,800
9908-4354-09	085409	STP-G 90	M10	-	30	810	6,200
9908-4355-09	085509	STP-G 110	M10	-	20	540	7,440
9908-4356-09	085609	STP-G 125	M10	-	15	405	7,980
9908-4357-09	085709	STP-G 160	M10	-	10	270	9,210

## STO1 P

Collare pesante con manicotto isolante AF/ARMALEX in buste trasparenti



Cod. europeo	Cod. fabbrica	Tipo	Descrizione	Conf. (pz)	Imballo (pz)	Pallet (pz)	€/pz
9908-1860-00	086000	STO1P 1/4"	Ø 10-14 - M8	1	10	560	18,060
9908-1860-10	086010	STO1P 3/8"	Ø 15-18 - M8	1	10	560	18,700
9908-1860-20	086020	STO1P 1/2"	Ø 20-25 - M8	1	10	560	19,470
9908-1860-30	086030	STO1P 3/4"	Ø 26-28 - M8	1	10	560	20,350
9908-1860-40	086040	STO1P 1"	Ø 32-35 - M8	1	10	560	23,280
9908-1860-50	086050	STO1P 1 1/4"	Ø 40-43 - M10	1	10	560	26,060
9908-1860-60	086060	STO1P 1 1/2"	Ø 48-50 - M10	1	10	560	27,350
9908-1860-70	086070	STO1P 2"	Ø 59-62 - M10	1	10	270	33,970
9908-1860-80	086080	STO1P 2 1/2"	Ø 75-78 - M10	1	6	162	61,200
9908-1860-90	086090	STO1P 3"	Ø 88-90 - 1/2" M12	1	4	108	84,460
9908-1861-00	086100	STO1P 4"	Ø 112-114 - 1/2" M12	1	3	81	98,430

## AIR G

Collare per canali d'aria circolari  
in scatola



Cod. europeo	Cod. fabbrica	Tipo	Descrizione	Conf. (pz)	Imballo (pz)	Pallet (pz)	€/pz
9908-2000-70	9908-2000-70	AIR G 71	M8 - Ø 71	1	25	1875	4,270
9908-2000-80	9908-2000-80	AIR G 80	M8 - Ø 80	1	25	1875	4,460
9908-2000-90	9908-2000-90	AIR G 90	M8 - Ø 90	1	20	1500	4,640
9908-2001-00	9908-2001-00	AIR G 100	M8 - Ø 100	1	20	1500	4,830
9908-2001-10	9908-2001-10	AIR G 112	M8 - Ø 112	1	20	1500	5,000
9908-2001-25	9908-2001-25	AIR G 125	M8 - Ø 125	1	20	1200	5,530
9908-2001-40	9908-2001-40	AIR G 140	M8 - Ø 140	1	20	1200	6,460
9908-2001-50	9908-2001-50	AIR G 150	M8 - Ø 150	1	20	480	6,650
9908-2001-60	9908-2001-60	AIR G 160	M8 - Ø 160	1	15	360	6,650
9908-2001-80	9908-2001-80	AIR G 180	M8 - Ø 180	1	15	900	7,770
9908-2002-00	9908-2002-00	AIR G 200	M8 - Ø 200	1	15	360	8,020
9908-2002-25	9908-2002-25	AIR G 224	M8 - Ø 224	1	15	360	10,620
9908-2002-50	9908-2002-50	AIR G 250	M8 - Ø 250	1	1	100	11,530
9908-2002-80	9908-2002-80	AIR G 280	M8 - Ø 280	1	1	100	13,770
9908-2003-00	9908-2003-00	AIR G 300	M8 - Ø 300	1	1	100	14,770
9908-2003-15	9908-2003-15	AIR G 315	M8 - Ø 315	1	1	100	15,100
9908-2003-55	9908-2003-55	AIR G 355	M8 - Ø 355	1	1	100	16,580
9908-2004-00	9908-2004-00	AIR G 400	M8 - Ø 400	1	1	100	18,960
9908-2004-50	9908-2004-50	AIR G 450	M10 - Ø 450	1	1	100	23,770
9908-2005-00	9908-2005-00	AIR G 500	M10 - Ø 500	1	1	100	26,040
9908-2005-60	9908-2005-60	AIR G 560	M10 - Ø 560	1	1	100	29,020
9908-2006-00	9908-2006-00	AIR G 600	M10 - Ø 600	1	1	100	30,220
9908-2006-30	9908-2006-30	AIR G 630	M10 - Ø 630	1	1	100	33,130
9908-2007-10	9908-2007-10	AIR G 710	M10 - Ø 710	1	1	100	34,630
9908-2008-00	9908-2008-00	AIR G 800	M10 - Ø 800	1	1	100	35,360
9908-2009-00	9908-2009-00	AIR G 900	M10 - Ø 900	1	1	100	43,430
9908-2010-00	9908-2010-00	AIR G 1000	M10 - Ø 1000	1	1	100	47,980
9908-2011-20	9908-2011-20	AIR G 1120	M10 - Ø 1120	1	1	100	57,220
9908-2012-50	9908-2012-50	AIR G 1250	M10 - Ø 1250	1	1	100	66,500

## DUPLEX G

Collare leggero con gomma EPDM e doppio filetto M8-M10  
in buste trasparenti



Cod. europeo	Cod. fabbrica	Tipo	Descrizione	Conf. (pz)	Imballo (pz)	Pallet (pz)	€/pz
9908-1920-00	9908-1920-00	DUPLEX G 3/8"	Ø 17-23 - M8/M10	1	150	11250	1,400
9908-1921-00	9908-1921-00	DUPLEX G 1/2"	Ø 21-26 - M8/M10	1	100	7500	1,580
9908-1922-00	9908-1922-00	DUPLEX G 3/4"	Ø 26-30 - M8/M10	1	100	7500	1,610
9908-1923-00	9908-1923-00	DUPLEX G 1"	Ø 33-37 - M8/M10	1	75	5625	1,720
9908-1924-00	9908-1924-00	DUPLEX G 1 1/4"	Ø 40-43 - M8/M10	1	50	4500	1,860
9908-1925-00	9908-1925-00	DUPLEX G 1 1/2"	Ø 48-53 - M8/M10	1	50	1500	2,080
9908-1925-50	9908-1925-50	DUPLEX G 50-55	Ø 50-55 - M8/M10	1	50	1500	2,260
9908-1926-00	9908-1926-00	DUPLEX G 2"	Ø 57-61 - M8/M10	1	50	1500	3,050
9908-1926-50	9908-1926-50	DUPLEX G 70-73	Ø 70-73 - M8/M10	1	25	1125	3,380
9908-1927-00	9908-1927-00	DUPLEX G 2 1/2"	Ø 74-80 - M8/M10	1	25	1125	3,770
9908-1928-00	9908-1928-00	DUPLEX G 3"	Ø 83-91 - M8/M10	1	20	900	4,070
9908-1928-50	9908-1928-50	DUPLEX G 101-106	Ø 101-106 - M8/M10	1	20	300	4,550
9908-1929-00	9908-1929-00	DUPLEX G 4"	Ø 108-114 - M8/M10	1	20	300	5,160
9908-1929-10	9908-1929-10	DUPLEX G 115-120	Ø 115-120 - M8/M10	1	20	240	5,500
9908-1929-20	9908-1929-20	DUPLEX G 125-130	Ø 125-130 - M8/M10	1	20	240	5,700
9908-1929-30	9908-1929-30	DUPLEX G 5"	Ø 131-135 - M8/M10	1	20	240	6,970

## CLIPPO

Collare a clip con gomma EPDM  
in scatola



Cod. europeo	Cod. fabbrica	Tipo	Descrizione	Conf. (pz)	Imballo (pz)	Pallet (pz)	€/pz
9908-3110-00	081000	CLIPPO 1/4"	Ø12-14 - M8	-	50	6000	2,870
9908-3110-10	081010	CLIPPO 3/8"	Ø15-18 - M8	-	50	6000	2,900
9908-3110-20	081020	CLIPPO 1/2"	Ø20-23 - M8	-	50	6000	3,020
9908-3110-30	081030	CLIPPO 3/4"	Ø25-28 - M8	-	50	6000	3,110
9908-3110-40	081040	CLIPPO 1"	Ø32-35 - M8	-	50	2800	3,340
9908-3110-50	081050	CLIPPO 1 1/4"	Ø40-43 - M8	-	50	2800	3,610
9908-3110-60	081060	CLIPPO 1 1/2"	Ø48-50 - M8	-	50	2800	3,890
9908-3110-70	081070	CLIPPO 54	Ø50-54 - M8	-	40	2240	4,160
9908-3110-80	081080	CLIPPO 2"	Ø60-63 - M8	-	40	2240	4,270

## CLIPPO S

Collare a clip scorrevole con gomma EPDM  
in scatola



Cod. europeo	Cod. fabbrica	Tipo	Descrizione	Conf. (pz)	Imballo (pz)	Pallet (pz)	€/pz
9908-3110-15	081015	CLIPPO S 3/8"	Ø 16 - M8	-	50	6000	3,360
9908-3110-25	081025	CLIPPO S 1/2"	Ø 20 - M8	-	50	6000	3,510
9908-3110-35	081035	CLIPPO S 3/4"	Ø 26 - M8	-	50	6000	3,770
9908-3110-45	081045	CLIPPO S 1"	Ø 32 - M8	-	50	2800	4,040
9908-3110-55	081055	CLIPPO S 1 1/4"	Ø 40 - M8	-	50	2800	4,370
9908-3110-65	081065	CLIPPO S 1 1/2"	Ø 50 - M8	-	50	2800	4,670
9908-3110-85	081085	CLIPPO S 2"	Ø 63 - M8	-	40	2240	5,220

## STP

Collare leggero per tubi PE e con adattatore M/F  
in buste trasparenti



Cod. europeo	Cod. fabbrica	Tipo	Descrizione	Conf. (pz)	Imballo (pz)	Pallet (pz)	€/pz
9908-4050-00	085000	STP 40	Adattatore M10x1/2"	1	50	1350	4,410
9908-4051-00	085100	STP 50	Adattatore M10x1/2"	1	50	1350	4,550
9908-4052-00	085200	STP 63	Adattatore M10x1/2"	1	50	1350	4,930
9908-4053-00	085300	STP 75	Adattatore M10x1/2"	1	50	1350	5,270
9908-4054-00	085400	STP 90	Adattatore M10x1/2"	1	35	945	5,490
9908-4055-00	085500	STP 110	Adattatore M10x1/2"	1	35	945	5,990
9908-4056-00	085600	STP 125	Adattatore M10x1/2"	1	25	675	6,560
9908-4056-50	085650	STP 140	Adattatore M10x1/2"	1	25	675	7,150
9908-4057-00	085700	STP 160	Adattatore M10x1/2"	1	20	540	7,690

## STP

Collare pesante per tubi PE con dado 1/2" GAS  
in buste trasparenti



Cod. europeo	Cod. fabbrica	Tipo	Descrizione	Conf. (pz)	Imballo (pz)	Pallet (pz)	€/pz
9908-4058-02	085802	STP 200	Dado 1/2"	-	10	270	22,410
9908-4058-52	085852	STP 250	Dado 1/2"	-	10	270	31,170
9908-4059-02	085902	STP 315	Dado 1/2"	-	10	210	35,520
9908-4059-52*	085952	STP 400	Dado 1/2"	-	1	-	42,730

\* confezionato sfuso

## STP1

Collare leggero per tubi con dado 1/2" GAS  
in buste trasparenti



Cod. europeo	Cod. fabbrica	Tipo	Descrizione	Conf. (pz)	Imballo (pz)	Pallet (pz)	€/pz
9908-4150-01	085001	STP1 40	Dado 1/2"	1	50	1350	4,890
9908-4151-01	085101	STP1 50	Dado 1/2"	1	50	1350	5,050
9908-4152-01	085201	STP1 63	Dado 1/2"	1	50	1350	5,470
9908-4153-01	085301	STP1 75	Dado 1/2"	1	50	1350	5,850
9908-4154-01	085401	STP1 90	Dado 1/2"	1	35	945	6,110
9908-4155-01	085501	STP1 110	Dado 1/2"	1	35	945	6,600
9908-4156-01	085601	STP1 125	Dado 1/2"	1	25	675	7,330
9908-4156-51	085651	STP1 140	Dado 1/2"	1	25	675	7,980
9908-4157-01	085701	STP1 160	Dado 1/2"	1	20	540	8,540

## STP1

Collare pesante per tubi PE con manicotto 1" GAS  
in scatola



Cod. europeo	Cod. fabbrica	Tipo	Descrizione	Conf. (pz)	Imballo (pz)	Pallet (pz)	€/pz
9908-4158-01	085801	STP1 200	Manicotto 1"	-	10	270	29,000
9908-4158-21	085821	STP1 220	Manicotto 1"	-	10	270	36,830
9908-4158-51	085851	STP1 250	Manicotto 1"	-	10	210	39,490
9908-4159-01	085901	STP1 315	Manicotto 1"	-	10	210	45,210
9908-4159-51*	085951	STP1 400	Manicotto 1"	-	1	-	54,300

\* confezionato sfuso

## DIS

Distanziatore per collari  
in scatola



Cod. europeo	Cod. fabbrica	Tipo	Descrizione	Conf. (pz)	Imballo (pz)	Pallet (pz)	€/pz
9909-5069-00	166900	DIS	Per vite M6	-	100	300.000	0,370

## PG S

Guaina isolante in silicone  
in scatola



Cod. europeo	Cod. fabbrica	Tipo	Descrizione	Conf. (pz)	Imballo (pz)	Pallet (pz)	€/pz
9908-9960-01	166001	PG 4 S	Larghezza 20,5	-	10	1120	34,230
9908-9960-51	166051	PG 7 S	Larghezza 30	-	10	560	62,530

## PG

Guaina isolante in EDPM  
in scatola



Cod. europeo	Cod. fabbrica	Tipo	Descrizione	Conf. (pz)	Imballo (pz)	Pallet (pz)	€/pz
9908-9960-00	166000	PG 4	Larghezza 20,5	-	20	1120	11,330
9908-9960-40	166040	PG 6	Larghezza 40	-	20	420	28,250
9908-9960-50	166050	PG 7	Larghezza 30	-	20	420	19,520
9908-9962-00	166200	PG 8	Larghezza 20	-	20	540	16,190

## NP/NP1

Nastro in PVC  
in scatola

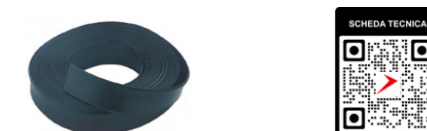

Cod. europeo	Cod. fabbrica	Tipo	Descrizione	Conf. (pz)	Imballo (pz)	Pallet (pz)	€/pz
9908-9990-00	089000	NP	30x1	10	50	2800	3,260
9908-9990-05	089005	NP1	40x1	10	30	1680	4,120

## COP

Coppella metallica universale  
in scatola



Cod. europeo	Cod. fabbrica	Tipo	Conf. (pz)	Imballo (pz)	Pallet (pz)	€/pz
9908-9780-00	088000	COP	50	200	24000	1,440

## PP/PP1/PP2/PP M8-M10

Piattelli per fissaggio collari in scatola

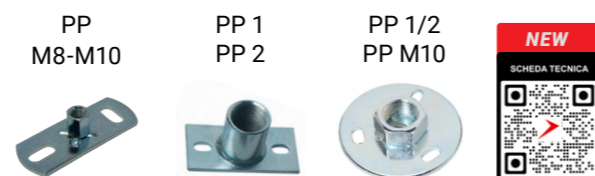

Cod. europeo	Cod. fabbrica	Tipo	Descrizione	Conf. (pz)	Imballo (pz)	Pallet (pz)	€/pz
9908-9794-50	089450	PP M10	Ø 70x3 - M10	-	100	5600	2,620
9908-9794-60	089460	PP 1/2	Ø 70x3 - 1/2"	-	100	5600	3,460
9908-9794-70	089470	PP1	50x100x4 - 1/2"	-	75	2800	5,880
9908-9794-80	089480	PP2	50x100x4 - 1"	-	50	1350	8,010
9908-9795-05	9908-9795-05	PP M8-M10	3x30x80	-	100	7200	1,990

## AD

Adattatore in scatola



Cod. europeo	Cod. fabbrica	Tipo	Descrizione	Conf. (pz)	Imballo (pz)	Pallet (pz)	€/pz
9908-9726-00	262600	AD/8	1/2" - M8	100	400	48000	1,530
9908-9727-00	262700	AD/10	1/2" - M10	100	400	48000	1,740
9908-9728-00	262800	AD/12	1/2" - M12	100	400	48000	2,050

## A

Riduzione MASCHIO - FEMMINA in scatola



Cod. europeo	Cod. fabbrica	Tipo	Descrizione	Conf. (pz)	Imballo (pz)	Pallet (pz)	€/pz
9908-9729-01	262901	A 8-10	M. 8 x F. 10	50	100	18000	3,690
9908-9729-00	262900	A 8-12	M. 8 x F. 12	50	100	18000	3,530
9908-9726-01	262601	A 8-1/2"	M. 8 x F. 1/2"	50	100	12000	5,210
9908-9729-02	262902	A 10-8	M. 10 x F. 8	50	100	18000	3,690
9908-9727-01	262701	A 10-1/2"	M. 10 x F. 1/2"	50	100	12000	5,210

## PLG M10

Aggancio per lamiera grecata M10 in scatola



Cod. europeo	Cod. fabbrica	Tipo	Descrizione	Conf. (pz)	Imballo (pz)	Pallet (pz)	€/pz
9908-9795-07	9908-9795-07	PLG M10	2,50x25 - M10	-	100	3000	2,260

## TNF

Fissaggio a martello per collari in buste trasparenti



Cod. europeo	Cod. fabbrica	Tipo	Descrizione	Conf. (pz)	Imballo (pz)	Pallet (pz)	€/pz
9903-0310-13	146401	10 TNF	8x90 - Giolli Ø10	2	100	2700	2,040
9903-0312-12	146501	12 TNF	10x100 - Giolli Ø12	2	100	2700	3,100

## TF

Fissaggio per collari in buste trasparenti



Cod. europeo	Cod. fabbrica	Tipo	Descrizione	Conf. (pz)	Imballo (pz)	Pallet (pz)	€/pz
9903-0310-12	146400	10 TF	8x90 - Giolli Ø10	2	100	2700	2,040
9903-0312-11	146500	12 TF	10x100 - Giolli Ø12	2	100	2700	3,100
9903-0312-13	146510	12 TF1	10x100 - Giolli Ø12	1	250	6750	1,310

\* Senza dado

## FC TECH

Fissaggio per collari in buste trasparenti



Cod. europeo	Cod. fabbrica	Tipo	Descrizione	Conf. (pz)	Imballo (pz)	Pallet (pz)	€/pz
9903-0118-60	131860	FC TECH M8	Vite 8x80 G-TECH Ø10	2	100	-	1,630
9903-0118-65	131865	FC TECH M10	Vite 10x90 G-TECH Ø12	2	100	-	2,480

## GIPROFIL

Profilo in rame con fissaggio in buste trasparenti



Cod. europeo	Cod. fabbrica	Tipo	Descrizione	Conf. (pz)	Imballo (pz)	Pallet (pz)	€/pz
9908-0290-00	099000	GIPROFIL	25 cm - Giolli Ø8	1	20	1120	22,520

## CR

Collarino in rame  
in buste trasparenti



Cod. europeo	Cod. fabbrica	Tipo	Descrizione	Conf. (pz)	Imballo (pz)	Pallet (pz)	€/pz
9908-0100-30	090030	CR 12	M6 - Giolli Ø6	5	100	12000	2,730
9908-0100-40	090040	CR 14	M6 - Giolli Ø6	5	100	12000	2,780
9908-0100-60	090060	CR 15/16	M6 - Giolli Ø6	5	100	12000	2,840
9908-0100-70	090070	CR18	M6 - Giolli Ø6	5	100	12000	2,870
9908-0100-90	090090	CR 22	M6 - Giolli Ø6	5	100	12000	2,940
9908-0101-30	090130	CR 28	M6 - Giolli Ø6	5	100	12000	3,200
9908-0101-50	090150	CR 35	M6 - Giolli Ø6	5	100	5600	4,130
9908-0101-60*	090160	CR 42	M6 senza vite	10	60	3360	4,610
9908-0101-70*	090170	CR 54	M6 senza vite	10	60	3360	5,820

\* in scatola

## GICOLLAR

Collare ad incastro in rame  
in buste trasparenti



Cod. europeo	Cod. fabbrica	Tipo	Descrizione	Conf. (pz)	Imballo (pz)	Pallet (pz)	€/pz
9908-0210-30	091030	GICOLLAR 12	M6	10	200	24000	2,580
9908-0210-40	091040	GICOLLAR 14	M6	10	200	24000	2,690
9908-0210-60	091060	GICOLLAR 15/16	M6	10	200	24000	2,880
9908-0210-70	091070	GICOLLAR 18	M6	10	200	24000	2,960
9908-0210-90	091090	GICOLLAR 22	M6	10	200	11200	3,110
9908-0211-30	091130	GICOLLAR 28	M6	10	200	11200	3,520
9908-0211-50	091150	GICOLLAR 35	M6	10	100	12000	4,400

## GIDADO

Aggancio per profilo in rame  
in buste trasparenti

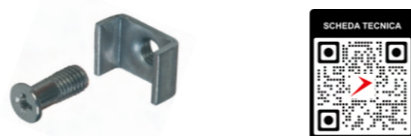

Cod. europeo	Cod. fabbrica	Tipo	Descrizione	Conf. (pz)	Imballo (pz)	Pallet (pz)	€/pz
9908-0290-10	099010	GIDADO	Per GIPROFIL	10	200	24000	2,000



## VGR

Vite autofilettante per fissaggio collari in rame  
in buste trasparenti



Cod. europeo	Cod. fabbrica	Tipo	Descrizione	Conf. (pz)	Imballo (pz)	Pallet (pz)	€/pz
9908-0247-25	164725	VGR1	M6x51x4,3 - Giolli Ø6	10	500	28000	0,970
9908-0247-27	164727	VGR2	M6x61x6,1 - Giolli Ø8	10	300	16800	1,670

## VLCR 6

Vite lunga per fissaggio collari in rame  
in buste trasparenti



Cod. europeo	Cod. fabbrica	Tipo	Descrizione	Conf. (pz)	Imballo (pz)	Pallet (pz)	€/pz
9908-0147-20	164720	VLCR6	M6x80x6 - Giolli Ø8	10	200	24000	1,660

## VP POL M6

Ancorante a percussione M6 MARRONE per collari in rame  
in scatola



Cod. europeo	Cod. fabbrica	Tipo	Descrizione	Conf. (pz)	Imballo (pz)	Pallet (pz)	€/pz
2500-0043-90	06740	VP POL M6	6x39	-	200	-	0,170

## CTR

Collare a diametro variabile  
in buste trasparenti



Cod. europeo	Cod. fabbrica	Tipo	Descrizione	Conf. (pz)	Imballo (pz)	Pallet (pz)	€/pz
9908-0630-03	093003	CTR 10/14	Foro Ø5	20	500	13500	1,030
9908-0630-04	093004	CTR 15/20	Foro Ø6	20	500	13500	1,380
9908-0630-05	093005	CTR 21/28	Foro Ø8	10	200	5400	2,390



## FR

Supporto a fissaggio rapido in scatola



Cod. europeo	Cod. fabbrica	Tipo	Descrizione	Conf. (pz)	Imballo (pz)	Pallet (pz)	€/pz
9908-0405-00	090500	FR 14	Foro Ø8	100	500	12000	0,630
9908-0405-10	090510	FR 16	Foro Ø8	100	500	12000	0,650
9908-0405-20	090520	FR 18	Foro Ø8	50	250	6000	0,680
9908-0405-30	090530	FR 20	Foro Ø8	50	250	6000	0,700
9908-0405-40	090540	FR 22	Foro Ø8	50	250	6000	0,770
9908-0405-60	090560	FR 25	Foro Ø8	50	250	6000	0,800
9908-0405-70	090570	FR 28	Foro Ø8	50	250	6000	0,900

## FRD

Supporto doppio a fissaggio rapido in scatola



Cod. europeo	Cod. fabbrica	Tipo	Descrizione	Conf. (pz)	Imballo (pz)	Pallet (pz)	€/pz
9908-0406-10	090610	FRD 16	Foro Ø8	100	500	6000	0,900
9908-0406-20	090620	FRD 18	Foro Ø8	100	500	6000	0,940
9908-0406-30	090630	FRD 20	Foro Ø8	50	250	6000	0,980
9908-0406-40	090640	FRD 22	Foro Ø8	50	250	6000	1,030
9908-0406-60	090660	FRD 25	Foro Ø8	40	200	4800	1,130

## G-CLIP

Collarino multidiametro in scatola



Cod. europeo	Cod. fabbrica	Tipo	Descrizione	Conf. (pz)	Imballo (pz)	Pallet (pz)	€/pz
9908-0520-10	092010	G-CLIP 14 - 18	Ø14 - 18 mm	50	250	14000	0,970
9908-0520-20	092020	G-CLIP 20 - 25	Ø20 - 25 mm	50	250	6000	1,230
9908-0520-30	092030	G-CLIP 25 - 32	Ø26 - 32 mm	50	250	6000	1,530
9908-0520-40	092040	G-CLIP 35 - 42	Ø35 - 42 mm	25	125	3000	2,680

## G-FAST

Ancorante di fissaggio rapido per G-CLIP in scatola



Cod. europeo	Cod. fabbrica	Tipo	Descrizione	Conf. (pz)	Imballo (pz)	Pallet (pz)	€/pz
9908-0520-95	092095	G-FAST	6x30 - Foro Ø6	-	100	300.000	0,260

## KIT G-CLIP

Kit di fissaggio per G-CLIP in buste trasparenti



Cod. europeo	Cod. fabbrica	Tipo	Descrizione	Conf. (pz)	Imballo (pz)	Pallet (pz)	€/pz
9908-0520-90	092090	KIT G-CLIP	M6 - Giolli Ø6	25	250	30.000	0,600

## CTF BRUNO

Collare a clip per tubi fumo in buste trasparenti



Cod. europeo	Cod. fabbrica	Tipo	Descrizione	Conf. (pz)	Imballo (pz)	Pallet (pz)	€/pz
9908-5030-22	073022	CTF 80 BRUNO	Giolli Ø10	1	20	1120	18,650
9908-5030-32	073032	CTF 100 BRUNO	Giolli Ø10	1	20	1120	19,510

## CTF BIANCO

Collare a clip per tubi fumo in buste trasparenti



Cod. europeo	Cod. fabbrica	Tipo	Descrizione	Conf. (pz)	Imballo (pz)	Pallet (pz)	€/pz
9908-5030-00	073000	CTF 60 BIANCO	Giolli Ø10	1	35	945	7,420
9908-5030-10	073010	CTF 70 BIANCO	Giolli Ø10	1	35	945	7,800
9908-5030-20	073020	CTF 80 BIANCO	Giolli Ø10	1	35	945	8,080
9908-5030-30	073030	CTF 100 BIANCO	Giolli Ø10	1	35	945	8,870
9908-5030-40	073040	CTF 110 BIANCO	Giolli Ø10	1	35	945	8,990
9908-5030-50	073050	CTF 120 BIANCO	Giolli Ø10	1	35	945	9,050
9908-5030-60	073060	CTF 130 BIANCO	Giolli Ø10	1	35	810	9,170
9908-5030-70	073070	CTF 140 BIANCO	Giolli Ø10	1	35	675	9,300
9908-5030-80	073080	CTF 150 BIANCO	Giolli Ø10	1	35	675	9,380

## STF

Fissaggio a diametro variabile per tubi fumo  
in buste trasparenti

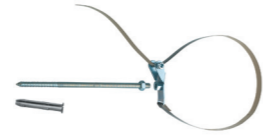

Cod. europeo	Cod. fabbrica	Tipo	Descrizione	Conf. (pz)	Imballo (pz)	Pallet (pz)	€/pz
9908-5500-00	070000	STF	Zincato - Giolli Ø10	1	35	945	9,170
9908-5501-00	070100	STF1	Bianco - Giolli Ø8	1	35	945	9,320

## FST

Fascetta per tubi fumo  
in buste trasparenti

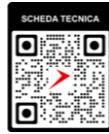

Cod. europeo	Cod. fabbrica	Tipo	Conf. (pz)	Imballo (pz)	Pallet (pz)	€/pz
9908-5511-00	071100	FST	1	70	1890	3,970

**SIMPLIFY  
YOUR  
WORK**

3.

## DATI TECNICI

### PESI DELLE TUBAZIONI E INTERASSI

Tubi di scarico in PE  
secondo DIN EN 12056 (DIN 19856)

DN	Dimensioni tubi	Ø Esterno	Spessore	Peso vuoto	Peso pieno d'acqua	Distanza max. supporti
DN	pollici	mm	mm	Kg/m	Kg/m	mt
32	1 1/4"	32	3	0,26	0,79	0,32
40	1 1/2"	40	3	0,36	1,26	0,40
50	2"	50	3	0,24	1,28	0,56
56	-	63	3	0,31	1,99	0,63
65	2 1/2"	75	3	0,49	3,93	0,75
90	-	90	3,5	0,95	6,36	0,90
100	4"	110	4,3	1,02	8,00	1,10
125	5"	125	4,9	1,35	12,43	1,25
150	6"	160	6,2	2,15	18,03	1,60
200	8"	200	6,2	3,76	31,40	2,00
250	10"	250	7,8	5,91	49,10	2,50
300	12"	315	9,8	9,36	77,89	3,15
400	16"	400	12,4	15,88	125,60	4,00

Tubi in Multistrato  
secondo UNI EN 10954-1

Ø Esterno	Spessore	Peso vuoto	Peso pieno d'acqua	Distanza max. supporti
mm	mm	Kg/m	Kg/m	mt
16	1,9	0,11	0,32	0,50
20	1,9	0,11	0,32	0,60
25	2,3	0,17	0,50	0,70
32	2,9	0,27	0,80	0,80
40	3,7	0,41	1,25	1,00
50	4,6	0,64	1,95	1,20
63	5,8	1,01	3,09	1,40
75	6,8	1,42	4,36	1,50

Tubi in Rame  
secondo DIN EN 1057 (DIN 1786)

Ø Esterno	Spessore	Peso vuoto	Peso pieno d'acqua	Distanza max. supporti
mm	mm	Kg/m	Kg/m	mt
8	1,0	0,20	0,24	0,40
10	1,0	0,25	0,30	0,50
12	1,0	0,31	0,39	0,50
14	1,0	0,36	0,47	0,70
16	1,0	0,39	0,52	0,80
18	1,0	0,48	0,68	1,00
22	1,0	0,59	0,90	1,50
28	1,5	1,11	1,60	1,50
35	1,5	1,41	2,21	1,50
42	1,5	1,70	2,90	1,50
54	2,0	2,91	4,87	1,50
64	2,0	3,47	6,29	2,00
76,1	2,0	4,14	8,23	2,00
88,9	2,0	4,86	10,52	2,00
108	2,5	7,37	15,71	2,50
133	3,0	10,90	23,57	2,50
159	3,0	13,09	31,47	2,50

#### N.B.

La distanza massima dei supporti è riferita ad installazioni orizzontali. I dati possono subire variazioni. Consultare e rispettare sempre i dati forniti dal produttore di tubazioni.

Per ulteriori dati materiali fare riferimento alle tabelle riportate a catalogo.

Tubi in acciaio saldati  
secondo pesante DIN EN 10220 (DIN 2448)

DN	Dimensioni tubi	Ø Esterno	Spessore	Peso vuoto	Peso pieno d'acqua	Distanza max. supporti
DN	pollici	mm	mm	Kg/m	Kg/m	mt
8	1/4"	13,5	1,8	0,52	0,60	1,30
8		16	1,8	0,63	0,75	1,30
10	3/8"	17,2	1,8	0,68	0,83	1,35
15	1/2"	21,3	2	0,95	1,19	1,50
20	3/4"	26,9	2,3	1,40	1,79	1,80
-	-	31,8	2,6	1,87	2,43	1,80
25	1"	33,7	2,6	1,99	2,63	2,15
32	1 1/4"	42,4	2,6	2,55	3,64	2,40
-	-	44,5	2,6	2,69	3,90	2,40
40	1 1/2"	48,3	2,6	2,93	4,39	2,60
-	-	51	2,6	3,10	4,75	2,60
50	2"	57	2,9	3,87	5,93	2,90
-	-	60,3	2,9	4,11	6,44	2,90
-	-	63,5	2,9	4,33	6,95	2,90
-	-	70	2,9	4,80	8,04	2,90
65	2 1/2"	76,1	2,9	5,24	9,12	3,20
80	3"	88,9	3,2	6,76	12,11	3,50
-	-	101,6	3,6	8,70	15,7	3,50
-	-	108	3,6	9,27	17,25	3,50
100	4"	114,3	3,6	9,83	18,84	4,00
-	-	127	4	12,13	23,26	4,00
-	-	133	4	12,73	25,00	4,00
125	5"	139,7	4	13,39	27,01	4,10
-	-	152,4	4,5	16,41	32,56	4,40
-	-	159	4,5	17,15	34,82	4,40
150	6"	168,3	4,5	18,16	38,11	4,40
-	-	177,8	5	21,31	43,42	4,80
-	-	193,7	5,6	25,98	52,14	5,00
200	8"	219,1	6,3	33,06	66,55	5,20
225	-	244,5	6,3	37,01	79,25	5,20
250	10"	273	6,3	41,44	94,59	5,20
300	12"	323,9	7,1	55,47	130,8	5,50
350	14"	355,6	8	68,58	159,16	6,00
400	16"	406,4	8,8	86,29	205,01	6,00

## DATI TECNICI DATI PER LA COMPOSIZIONE DEI COLLARI ISOLATI

Tubo	Collare	Guaina
Ø"	Ø mm	Tipo
3/8"	12 - 18	STO/STO1 1/2"
1/2"	19-23	STO/STO1 3/4"
3/4"	25-28	STO/STO1 1"
3/4"	26-30	STO/STO1 1 1/4"
1"	33-38	STO/STO1 1 1/4"
1"	32-35	STO/STO1 1 1/2"
	38-45	STP/STP1 50*
1 1/4"	39-44	STO/STO1 1 1/2"
1 1/2"	44-49	STO/STO1 2"
1 1/2"	50-54	STP/STP1 63*
	52-54	STO/STO1 2"
2"	60-64	STO/STO1 2 1/2"
2"	63-66	STP/STP1 75*
2 1/2"	73-78	STO/STO1 3"
	77-83	STP/STP1 90*
3"	85-90	STO/STO1 3 1/2"
3 1/2"	97-102	STO/STO1 4"
3 1/2"	98-102	STP/STP1 110*
4"	110-116	STP/STP1 125*
	122-126	STP/STP1 140*
	125-133	STO1 5"
	146-150	STP/STP1 160
	150-159	STO1 6"
	185-194	STP/STP1 200
	205-210	STO1 8
	205-210	STP1 220
	235-244	STP/STP1 250
	295-305	STP/STP1 315
	385-393	STP/STP1 400
3/8"	12 - 18	STO1 INOX 1/2"
1/2"	19-23	STO1 INOX 3/4"
3/4"	25-32	STO1 INOX 1 1/4"
3/4"	25-30	STO1 INOX 1"
1"	33-38	STO1 INOX 1 1/4"

Tubo	Collare	Guaina
Ø"	Ø mm	Tipo
1"	31-35	STO1 INOX 1 1/2"
1 1/4"	35-42	STO1 INOX 1 1/2"
1 1/2"	41-47	STO1 INOX 2"
	50-54	STO1 INOX 2"
2"	59-64	STO1 INOX 2 1/2"
2 1/2"	73-78	STO1 INOX 3"
3"	86-92	STO1 INOX 3 1/2"
3 1/2"	96-102	STO1 INOX 4"
	123-130	STO1 INOX 5"
	145-148	CTF INOX 160
	148-155	STO1 INOX 6"
	156-162	CTF INOX 180
	185-187	CTF INOX 200

\* senza distanziali

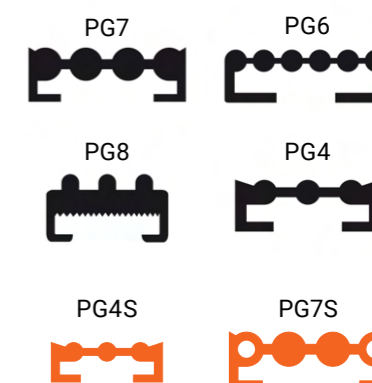

# DATI TECNICI

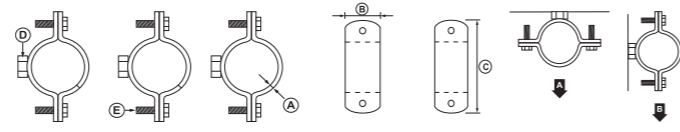

Cod. EU	Cod.	Collare	Per tubi Ø mm	Attacco	Viti laterali	Spessore	Larghezza	Ingombro	Carico amm. (daN)	Carico amm. (daN)
9999-1801-05	180105	FLIP1 3/8"	14 - 18	M8			20	53	45	70
9999-1801-10	180110	FLIP1 1/2"	20 - 24	M8			25	65	85	72
9999-1801-15	180115	FLIP1 3/4"	25 - 30	M8			25	70	90	75
9999-1801-20	180120	FLIP1 1"	32 - 36	M8			25	78	120	75
9999-1801-25	180125	FLIP1 1 1/4"	38 - 44	M8			27,5	86	120	75
9999-1801-30	180130	FLIP1 1 1/2"	44 - 50	M8-M10			27,5	92	130	70
9999-1801-35	180135	FLIP1 2"	56 - 63	M8-M10			28	105	150	65
9999-1801-40	180140	FLIP1 2 1/2"	74 - 80	M8-M10			30	123	170	45
9999-1801-45	180145	FLIP1 3"	84 - 90	M8-M10			30	136	170	40
9999-1804-05	180405	FLIP R 3/8"	14 - 18				20	53	65	65
9999-1804-10	180410	FLIP R 1/2"	20 - 24				25	65	90	85
9999-1804-15	180415	FLIP R 3/4"	25 - 30				25	70	100	85
9999-1804-20	180420	FLIP R 1"	32 - 36				25	78	100	85
9999-1804-25	180425	FLIP R 1 1/4"	38 - 44				27,5	86	100	85
9999-1804-30	180430	FLIP R 1 1/2"	44 - 50				27,5	92	100	90
9999-1804-35	180435	FLIP R 2"	56 - 63				28	105	100	90
9999-1804-40	180440	FLIP R 2 1/2"	74 - 80				30	126	170	120
9999-1804-45	180445	FLIP R 3"	84 - 90				30	137	170	120
9999-1808-45	180845	FLIP SI 90	84 - 90	M8-M10			30	136	170	40
9999-1808-50	180850	FLIP SI 110	100 - 110	M10			30	155	130	85
9999-1808-55	180855	FLIP SI 125	125 - 135	M10			30	182	180	130
9908-1220-00	082000	STO1 3/8"	17 - 19	M8	M6x20	2,5	20	53	200	100
9908-1221-00	082100	STO1 1/2"	20 - 24	M8	M6x20	2,5	20	58	200	100
9908-1222-00	082200	STO1 3/4"	26 - 29	M8	M6x20	3	20	64	250	100
9908-1223-00	082300	STO1 1"	32 - 36	M8	M6x20	3	20	72	250	100
9908-1224-00	082400	STO1 1 1/4"	40 - 44	M8	M6x20	3	20	81	250	100
9908-1225-00	082500	STO1 1 1/2"	46 - 50	M8	M6x20	3	20	88	250	100
9908-1225-50	082550	STO1 54	50 - 56	M8	M6x20	3	20	96	250	100
9908-1226-00	082600	STO1 2"	58 - 61	M8	M6x20	3	20	98	300	100
9908-1227-00	082700	STO1 2 1/2"	72 - 78	M10	M6x20	3	30	126	300	70
9908-1228-00	082800	STO1 3"	86 - 90	M10	M6x20	3	30	137	300	70
9908-1228-50	082850	STO1 3 1/2"	96 - 104	M10	M6x20	3	30	150	300	70
9908-1229-00	082900	STO1 4"	110 - 116	M10	M6x20	3	30	163	300	70
9908-1229-30	082930	STO1 5"	135 - 142	1/2"	M8x35	4	40	218	400	120
9908-1229-50	082950	STO1 6"	164 - 170	1/2"	M8x35	4	40	247	400	100
9908-1229-70	082970	STO1 8"	213 - 224	1/2"	M8x35	4	40	306	400	90

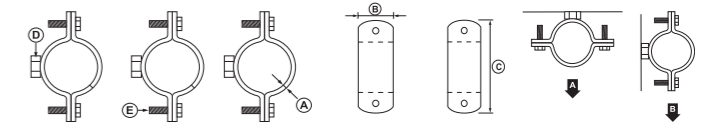

Cod. EU	Cod.	Collare	Per tubi Ø mm	Attacco	Viti laterali	Spessore	Larghezza	Ingombro	Carico amm. (daN)	Carico amm. (daN)
9908-2730-00	083000	CPF 3/8"	17-18		M6x20	2,5	25	23	200	20
9908-2731-00	083100	CPF 1/2"	21-22		M6x20	2,5	25	27	200	20
9908-2732-00	083200	CPF 3/4"	26-28		M6x20	2,5	25	33	200	30
9908-2733-00	083300	CPF 1"	33-34		M6x20	2,5	25	39	200	30
9908-2734-00	083400	CPF 1 1/4"	42-43		M6x20	2,5	25	48	200	30
9908-2735-00	083500	CPF 1 1/2"	47-50		M8x35	3	25	56	300	40
9908-2736-00	083600	CPF 2"	60-63		M8x35	3	25	69	300	40
9908-2737-00	083700	CPF 2 1/2"	75-78		M8x35	3	25	84	300	40
9908-2738-00	083800	CPF 3"	88-90		M8x35	3	25	96	300	40
9908-2739-00	083900	CPF 4"	110-115		M8x35	3	25	121	300	40
9908-2739-10	083910	CPF3 1/2"	22		M8x25	2	32	26	200	20
9908-2739-15	083915	CPF3 3/4"	28		M8x25	2	32	32	200	30
9908-2739-20	083920	CPF3 1"	35		M8x25	2	32	39	200	30
9908-2739-25	083925	CPF3 1 1/4"	44		M8x35	2	32	48	200	30
9908-2739-30	083930	CPF3 1 1/2"	50		M8x35	2	32	54	300	40
9908-2739-35	083935	CPF3 2"	62		M8x35	2	32	66	300	40
9908-2739-40	083940	CPF3 2 1/2"	78		M8x35	2	32	82	300	40
9908-2739-45	083945	CPF3 3"	90		M8x35	2	32	94	300	40
9908-2739-55	083955	CPF3 4"	116		M8x35	2	32	120	300	40
9908-2739-60	083960	CPF3 5"	141		M8x35	2	32	145	300	40
9908-2870-00	167000	CAV 3/8"	17 - 18	M6		6	6	30,5		
9908-2872-00	167200	CAV 1/2"	21 - 22	M6		6	6	35,5		
9908-2874-00	167400	CAV 3/4"	26 - 28	M6		6	6	40		
9908-2876-00	167600	CAV 1"	33 - 34	M6		6	6	46		
9908-2878-00	167800	CAV 1 1/4"	42 - 43	M6		6	6	55,5		
9908-2880-00	168000	CAV 1 1/2"	47 - 50	M8		8	8	66		
9908-2882-00	168200	CAV 2"	60 - 63	M8		8	8	77		
9908-2884-00	168400	CAV 2 1/2"	75 - 78	M8		8	8	93		
9908-2886-00	168600	CAV 3"	88 - 90	M8		8	8	105		
9908-2888-00	168800	CAV 3 1/2"	100 - 102	M8		8	8	116		
9908-2890-00	169000	CAV 4"	110 - 115	M8		8	8	131		
9908-2891-00	169100	CAV 5"	135 - 140	M8		8	8	158		
9908-2892-00	169200	CAV 6"	163 - 168	M8		8	8	184		
9908-2893-00	169300	CAV 8"	215 - 220	M10		10	10	240		



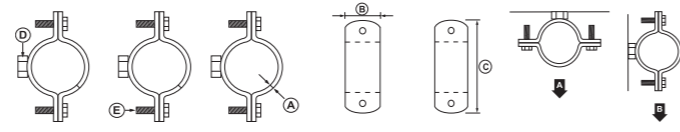

Cod. EU	Cod.	Collare	Per tubi Ø mm	Attacco	Viti laterali	Spessore	Larghezza	Ingombro	Carico amm. (daN)	Carico amm. (daN)
9908-3543-00	084300	CSP 1"	32 - 38	M10		1,1	16		133	
9908-3544-00	084400	CSP 1 1/4"	39 - 44	M10		1,1	16		133	
9908-3545-00	084500	CSP 1 1/2"	45 - 50	M10		1,1	16		133	
9908-3546-00	084600	CSP 2"	60 - 65	M10		1,1	16		133	
9908-3547-00	084700	CSP 2 1/2"	72 - 78	M10		2,2	16		234	
9908-3548-00	084800	CSP 3"	85 - 90	M10		2,2	16		234	
9908-3549-00	084900	CSP 4"	108 - 115	M10		2,2	16		289	
9908-3549-30	084930	CSP 5"	137 - 142	M12		2,5	19		289	
9908-3549-50	084950	CSP 6"	164 - 169	M12		2,5	19		445	
9908-3549-70	084970	CSP 8"	215 - 220	M12		3	19		600	
9908-1620-09	082009	STO1 G 3/8"	12 - 18	M8	M6x20	2,5	20	58	200	100
9908-1621-09	082109	STO1 G 1/2"	19 - 23	M8	M6x20	3	20	64	200	100
9908-1622-09	082209	STO1 G 3/4"	25 - 30	M8	M6x20	3	20	72	200	100
9908-1623-09	082309	STO1 G 1"	33 - 38	M8	M6x20	3	20	81	200	100
9908-1624-09	082409	STO1 G 1 1/4"	39 - 44	M8	M6x20	3	20	88	200	100
9908-1625-09	082509	STO1 G 1 1/2"	45 - 49	M8	M6x20	3	20	97	200	100
9908-1625-59	082559	STO1 G 54	50 - 54	M8	M6x20	3	20	98	200	100
9908-1626-09	082609	STO1 G 2"	60 - 64	M10	M6x20	3	30	126	250	70
9908-1627-09	082709	STO1 G 2 1/2"	73 - 78	M10	M6x20	3	30	137	250	70
9908-1628-09	082809	STO1 G 3"	85 - 90	M10	M6x20	3	30	150	250	70
9908-1628-59	082859	STO1 G 3 1/2"	97 - 102	M10	M6x20	3	30	163	250	70
9908-1629-09	082909	STO1 G 4"	110 - 116	M10	M6x20	3	30	181	250	70
9908-1629-39	082939	STO1 G 5"	138 - 141	1/2"	M6x20	3	30	203	250	70
9908-1629-59	082959	STO1 G 6"	165 - 169	1/2"	M6x20	3	30	237	250	70
9908-1629-69	082969	STO1G 200	200 - 205	1/2"	M8x35	4	40	306	350	80
9908-1629-79	082979	STO1 G 8"	215 - 220	1/2"	M8x35	4	40	314	350	80
9908-1629-99	082999	STO1 G 10"	269 - 274	1/2"	M8x35	4	40	366	350	80

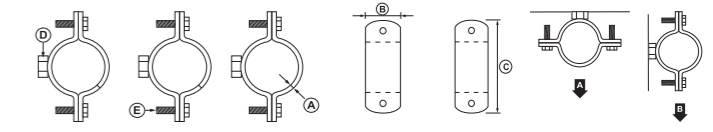

Cod. EU	Cod.	Collare	Per tubi Ø mm	Attacco	Viti laterali	Spessore	Larghezza	Ingombro	Carico amm. (daN)	Carico amm. (daN)
9908-1762-00	086200	STO1GS 3/8"	12 - 18	M8	M6x20	2,5	20	58	200	100
9908-1762-10	086210	STO1GS 1/2"	19 - 23	M8	M6x20	3	20	64	200	100
9908-1762-20	086220	STO1GS 3/4"	25 - 30	M8	M6x20	3	20	72	200	100
9908-1762-30	086230	STO1GS 1"	33 - 38	M8	M6x20	3	20	81	200	100
9908-1762-40	086240	STO1GS 1 1/4"	39 - 44	M8	M6x20	3	20	88	200	100
9908-1762-50	086250	STO1GS 1 1/2"	45 - 49	M8	M6x20	3	20	97	200	100
9908-1762-55	086255	STO1GS 54	50 - 54	M8	M6x20	3	20	98	200	100
9908-1762-60	086260	STO1GS 2"	60 - 64	M10	M6x20	3	30	126	250	70
9908-1762-70	086270	STO1GS 2 1/2"	73 - 78	M10	M6x20	3	30	137	250	70
9908-1762-80	086280	STO1GS 3"	85 - 90	M10	M6x20	3	30	150	250	70
9908-1762-85	086285	STO1GS 3 1/2"	97 - 102	M10	M6x20	3	30	163	250	70
9908-1762-90	086290	STO1GS 4"	110 - 116	M10	M6x20	3	30	181	250	70
9908-1762-93	086293	STO1GS 5"	138 - 141	1/2"	M6x20	3	30	203	250	70
9908-1762-95	086295	STO1GS 6"	165 - 169	1/2"	M6x20	3	30	237	250	70
9908-3110-00	081000	CLIPPO 1/4"	12 - 14	M8	M5x25	1,5	20	45	70	60
9908-3110-10	081010	CLIPPO 3/8"	15 - 18	M8	M5x25	1,5	20	50	70	60
9908-3110-20	081020	CLIPPO 1/2"	20 - 23	M8	M5x25	1,5	20	54	70	60
9908-3110-30	081030	CLIPPO 3/4"	25 - 28	M8	M5x25	1,5	20	58	70	60
9908-3110-40	081040	CLIPPO 1"	32 - 35	M8	M5x25	1,5	20	66	70	60
9908-3110-50	081050	CLIPPO 1 1/4"	40 - 43	M8	M5x25	1,5	20	73	70	60
9908-3110-60	081060	CLIPPO 1 1/2"	48 - 50	M8	M5x25	1,5	20	81	70	60
9908-3110-70	081070	CLIPPO 54	50 - 54	M8	M5x25	1,5	20	96	70	60
9908-3110-80	081080	CLIPPO 2"	60 - 63	M8	M5x25	1,5	20	96	70	60
9908-3110-15	081015	CLIPPO S 3/8"	16	M8	M5x25	1,5	20	50	70	60
9908-3110-25	081025	CLIPPO S 1/2"	20	M8	M5x25	1,5	20	54	70	60
9908-3110-35	081035	CLIPPO S 3/4"	25	M8	M5x25	1,5	20	58	70	60
9908-3110-45	081045	CLIPPO S 1"	32	M8	M5x25	1,5	20	66	70	60
9908-3110-55	081055	CLIPPO S 1 1/4"	40	M8	M5x25	1,5	20	73	70	60
9908-3110-65	081065	CLIPPO S 1 1/2"	50	M8	M5x25	1,5	20	81	70	60
9908-3110-85	081085	CLIPPO S 2"	63	M8	M5x25	1,5	20	96	70	60

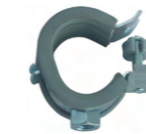

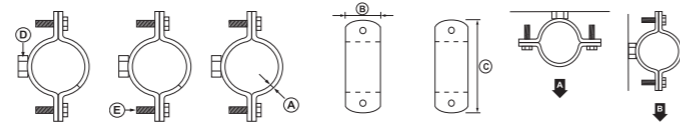

Cod. EU	Cod.	Collare	Per tubi Ø mm	Attacco	Viti laterali	Spessore	Larghezza	Ingombro	Carico amm. (daN)	Carico amm. (daN)
9908-1860-00	086000	STO1P 1/4"	10 - 14	M8	M6x20	3	45	72	200	100
9908-1860-10	086010	STO1P 3/8"	15 - 18	M8	M6x20	3	45	81	200	100
9908-1860-20	086020	STO1P 1/2"	20 - 25	M8	M6x20	3	45	88	250	100
9908-1860-30	086030	STO1P 3/4"	26 - 28	M8	M6x20	3	45	93	250	100
9908-1860-40	086040	STO1P 1"	32 - 35	M8	M6x20	3	50	98	250	100
9908-1860-50	086050	STO1P 1 1/4"	40 - 43	M10	M6x20	3	50	117	250	100
9908-1860-60	086060	STO1P 1 1/2"	48 - 50	M10	M6x20	3	55	126	250	100
9908-1860-70	086070	STO1P 2"	59 - 62	M10	M6x20	3	65	137	300	100
9908-1860-80	086080	STO1P 2 1/2"	75 - 78	M10	M6x20	3	85	181	300	70
9908-1860-90	086090	STO1P 3"	88 - 90	F.1/2"-F.M12	M8x35	4	100	218	300	70
9908-1861-00	086100	STO1P 4"	112 - 114	F.1/2"-F.M12	M8x35	4	115	247	300	70
9908-4570-75	087075	SI 75-78	75 - 78	1/2" x M10	M6x40	2,5	25	127	50	70
9908-4570-90	087090	SI 90	90	1/2" x M10	M6x40	2,5	25	142	50	70
9908-4571-10	087110	SI 110	110	1/2" x M10	M6x40	2,5	25	163	50	70
9908-4571-25	087125	SI 125	125	1/2" x M10	M6x40	2,5	25	180	50	70
9908-4571-35	087135	SI 135	135	1/2" x M10	M6x40	2,5	25	190	50	70
9908-4571-60	087160	SI 160	160	1/2" x M10	M6x40	2,5	25	218	50	70
9908-4050-00	085000	STP 40	40	1/2" x M10	M6x20	3	30	89	300	150
9908-4051-00	085100	STP 50	50	1/2" x M10	M6x20	3	30	99	300	150
9908-4052-00	085200	STP 63	63	1/2" x M10	M6x20	3	30	113	300	150
9908-4053-00	085300	STP 75	75	1/2" x M10	M6x20	3	30	126	300	150
9908-4054-00	085400	STP 90	90	1/2" x M10	M6x20	3	30	141	300	100
9908-4055-00	085500	STP 110	110	1/2" x M10	M6x20	3	30	163	300	100
9908-4056-00	085600	STP 125	125	1/2" x M10	M6x20	3	30	182	300	80
9908-4056-50	085650	STP 140	140	1/2" x M10	M6x20	3	30	194	300	60
9908-4057-00	085700	STP 160	160	1/2" x M10	M6x20	3	30	216	300	40
9908-4058-02	085802	STP 200	200	1/2"	M8x35	4	40	283	400	100
9908-4058-52	085852	STP 250	250	1/2"	M8x35	4	40	334	400	70
9908-4059-02	085902	STP 315	315	1/2"	M8x35	4	40	400	400	70
9908-4059-52	085952	STP 400	400	1/2"	M8x35	4	40	501	400	40

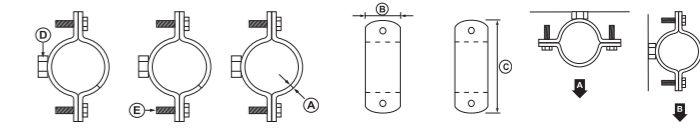

Cod. EU	Cod.	Collare	Per tubi Ø mm	Attacco	Viti laterali	Spessore	Larghezza	Ingombro	Carico amm. (daN)	Carico amm. (daN)
9908-4150-01	085001	STP1 40	40	1/2"	M6x20	3	30	89	300	150
9908-4151-01	085101	STP1 50	50	1/2"	M6x20	3	30	99	300	150
9908-4152-01	085201	STP1 63	63	1/2"	M6x20	3	30	113	300	150
9908-4153-01	085301	STP1 75	75	1/2"	M6x20	3	30	126	300	150
9908-4154-01	085401	STP1 90	90	1/2"	M6x20	3	30	141	300	100
9908-4155-01	085501	STP1 110	110	1/2"	M6x20	3	30	163	300	100
9908-4156-01	085601	STP1 125	125	1/2"	M6x20	3	30	182	300	80
9908-4156-51	085651	STP1 140	140	1/2"	M6x20	3	30	194	300	60
9908-4157-01	085701	STP1 160	160	1/2"	M6x20	3	30	216	300	40
9908-4158-01	085801	STP1 200	200	1"	M8x35	4	40	283	400	100
9908-4158-21	085821	STP1 220	220	1"	M8x35	4	40	306	400	90
9908-4158-51	085851	STP1 250	250	1"	M8x35	4	40	336	400	70
9908-4159-01	085901	STP1 315	315	1"	M8x35	4	40	400	400	70
9908-4159-51	085951	STP1 400	400	1"	M8x35	4	40	501	400	40
9908-0100-30	090030	CR 12	12	M6	TC 5X10	1	10	38	40	30
9908-0100-40	090040	CR 14	14	M6	TC 5X10	1	10	38	40	30
9908-0100-60	090060	CR 15/16	15 - 16	M6	TC 5X10	1	10	42	40	30
9908-0100-70	090070	CR 18	18	M6	TC 5X10	1	10	42	40	30
9908-0100-90	090090	CR 22	22	M6	TC 5X10	1	10	45	40	30
9908-0101-30	090130	CR 28	28	M6	TC 5X10	1	10	56	40	30
9908-0101-50	090150	CR 35	35	M6	TC 5X10	1	12	67	40	30
9908-0101-60	090160	CR 42	42	M6	TC 5X10	1	11	79	40	30
9908-0101-70	090170	CR 54	54	M6	TC 5X10	1,2	14	99	40	30
9908-0210-30	091030	GICOLLAR 12	12	M6	TCCI 6X7,5	1,5	15	15	50	35
9908-0210-40	091040	GICOLLAR 14	14	M6	TCCI 6X7,5	1,5	15	20,5	50	35
9908-0210-60	091060	GICOLLAR 15-16	15 - 16	M6	TCCI 6X7,5	1,5	15	22,5	50	35
9908-0210-70	091070	GICOLLAR 18	18	M6	TCCI 6X7,5	1,5	15	24,5	50	35
9908-0210-90	091090	GICOLLAR 22	22	M6	TCCI 6X7,5	1,5	15	29,5	50	35
9908-0211-30	091130	GICOLLAR 28	28	M6	TCCI 6X7,5	1,5	15	35,5	50	35
9908-0211-50	091150	GICOLLAR 35	35	M6	TCCI 6X7,5	1,5	15	44,5	50	35



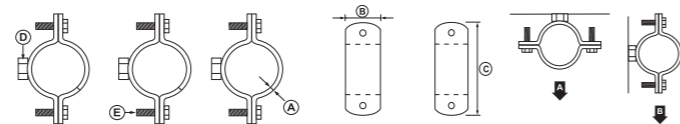

	Cod. EU	Cod.	Collare	Per tubi Ø mm	Attacco	Viti laterali	Spessore	Larghezza	Ingombro	Carico amm. (daN)	Carico amm. (daN)
	9999-0853-09	085309	STP-G 75	75	M10	M6x20	2,5	25	126	200	70
	9999-0854-09	085409	STP-G 90	90	M10	M6x20	2,5	25	141	200	70
	9999-0855-09	085509	STP-G 110	110	M10	M6x20	2,5	25	163	200	70
	9999-0856-09	085609	STP-G 125	125	M10	M6x20	2,5	25	182	200	70
	9999-0857-09	085709	STP-G 160	160	M10	M6x20	2,5	25	216	200	70
	9908-2000-70	-	AIR G 71	71	M8	M6x20	1,5	20	111	90	-
	9908-2000-80	-	AIR G 80	80	M8	M6x20	1,5	20	120	90	-
	9908-2000-90	-	AIR G 90	90	M8	M6x20	1,5	20	130	90	-
	9908-2001-00	-	AIR G 100	100	M8	M6x20	1,5	20	140	90	-
	9908-2001-10	-	AIR G 112	112	M8	M6x20	1,5	20	152	90	-
	9908-2001-25	-	AIR G 125	125	M8	M6x20	1,5	20	165	90	-
	9908-2001-40	-	AIR G 140	140	M8	M6x20	1,5	20	180	90	-
	9908-2001-50	-	AIR G 150	150	M8	M6x20	1,5	20	190	90	-
	9908-2001-60	-	AIR G 160	160	M8	M6x20	1,5	20	200	90	-
	9908-2001-80	-	AIR G 180	180	M8	M6x20	1,5	20	220	90	-
	9908-2002-00	-	AIR G 200	200	M8	M6x20	1,5	20	240	90	-
	9908-2002-25	-	AIR G 224	224	M8	M6x20	1,5	20	264	90	-
	9908-2002-50	-	AIR G 250	250	M8	M6x20	2	25	290	90	-
	9908-2002-80	-	AIR G 280	280	M8	M6x20	2	25	320	90	-
	9908-2003-00	-	AIR G 300	300	M8	M6x20	2	25	340	90	-
	9908-2003-15	-	AIR G 315	315	M8	M6x20	2	25	355	90	-
	9908-2003-55	-	AIR G 355	355	M8	M6x20	2	25	395	90	-
	9908-2004-00	-	AIR G 400	400	M8	M6x20	2	25	440	90	-
	9908-2004-50	-	AIR G 450	450	M10	M6x20	3	25	490	200	-
	9908-2005-00	-	AIR G 500	500	M10	M6x20	3	25	540	200	-
	9908-2005-60	-	AIR G 560	560	M10	M6x20	3	25	600	200	-
	9908-2006-00	-	AIR G 600	600	M10	M6x20	3	25	640	200	-
	9908-2006-30	-	AIR G 630	630	M10	M6x20	3	25	670	200	-
	9908-2007-10	-	AIR G 710	710	M10	M6x20	3	25	750	200	-
	9908-2008-00	-	AIR G 800	800	M10	M6x20	3	25	840	200	-
9908-2009-00	-	AIR G 900	900	M10	M6x20	3	25	940	200	-	
9908-2010-00	-	AIR G 1000	1000	M10	M6x20	3	25	1040	200	-	
9908-2011-20	-	AIR G 1120	1120	M10	M6x20	3	25	1160	200	-	
9908-2012-50	-	AIR G 1250	1250	M10	M6x20	3	25	1290	200	-	

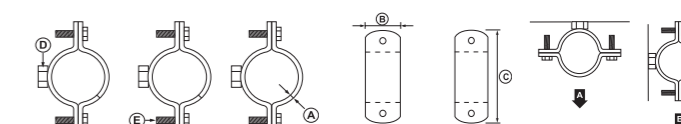

	Cod. EU	Cod.	Collare	Per tubi Ø mm	Attacco	Viti laterali	Spessore	Larghezza	Ingombro	Carico amm. (daN)	Carico amm. (daN)
	9908-1920-00	-	DUPLEX G 3/8"	17-23	M8-M10	M6x20	1,5	20	63	120	70
	9908-1921-00	-	DUPLEX G 1/2"	21-26	M8-M10	M6x20	1,5	20	66	120	70
	9908-1922-00	-	DUPLEX G 3/4"	26-30	M8-M10	M6x20	1,5	20	70	120	70
	9908-1923-00	-	DUPLEX G 1"	33-37	M8-M10	M6x20	1,5	20	77	120	70
	9908-1924-00	-	DUPLEX G 1 1/4"	40-43	M8-M10	M6x20	1,5	20	83	120	70
	9908-1925-00	-	DUPLEX G 1/2"	48-53	M8-M10	M6x20	1,5	20	93	120	70
	9908-1925-50	-	DUPLEX G 50-55	50-55	M8-M10	M6x20	1,5	20	95	120	70
	9908-1926-00	-	DUPLEX G 2"	57-61	M8-M10	M6x20	1,5	20	101	120	70
	9908-1926-50	-	DUPLEX G 70-73	70-73	M8-M10	M6x20	1,5	20	113	120	70
	9908-1927-00	-	DUPLEX G 2 1/2"	74-80	M8-M10	M6x20	1,5	20	120	120	70
	9908-1928-00	-	DUPLEX G 3"	83-91	M8-M10	M6x20	1,5	20	131	120	70
	9908-1928-50	-	DUPLEX G 101-106"	101-106	M8-M10	M6x20	1,5	20	146	120	70
	9908-1929-00	-	DUPLEX G 4"	108-114	M8-M10	M6x20	1,5	20	154	120	70
	9908-1929-10	-	DUPLEX G 115-120	115-120	M8-M10	M6x20	2	20	160	150	70
	9908-1929-20	-	DUPLEX G 125-130	125-130	M8-M10	M6x20	2	20	170	150	70
	9908-1929-30	-	DUPLEX G 5"	131-135	M8-M10	M6x20	2	20	175	150	70

# 4. ACCESSORI DI FISSAGGIO



Gli accessori di fissaggio di GIA comprendono barre e tubi filettati, manicotti, riduzioni, bandelle preforate e porta-etichette, elementi essenziali per le operazioni di montaggio e supporto degli impianti.

Le staffe SUV, specifiche per vasi di espansione, dimostrano l'impegno dell'azienda nella ricerca e sviluppo: ascoltare le esigenze degli installatori e tradurle in soluzioni pratiche e innovative è da sempre filosofia professionale di GIA.

SCOPRI DI PIÙ,  
INQUADRA IL  
QR CODE



## Staffe per vasi d'espansione

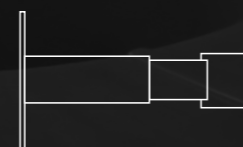

SUV  
staffa telescopica per vasi d'espansione con manicotto da 3/4" e 1"

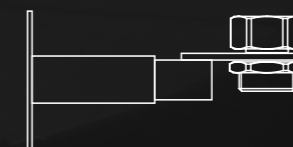

SUV 2  
staffa telescopica per vasi d'espansione con raccordo in ottone da 3/4"



SUV 3  
staffa telescopica per vasi d'espansione con valvola di ritegno bidirezionale in ottone da 3/4"

## Caratteristiche tecniche

SUV  
Per vasi fino a 50 litri, regolazione della distanza dal muro da 160mm a 220 mm

SUV 2  
Certificato DM 174  
Per vasi fino a 50 litri, regolazione della distanza dal muro da 160mm a 220 m

SUV 3  
Certificato DM 174  
Per vasi fino a 50 litri, regolazione della distanza dal muro da 160mm a 220 mm

## SUV

Staffa telescopica per vasi di espansione in scatola



Cod. europeo	Cod. fabbrica	Tipo	Descrizione	Conf. (pz)	Imballo (pz)	Pallet (pz)	€/pz
9999-0755-10	075510	SUV 3/4"	3/4"	1	10	560	24,670
9999-0755-20	075520	SUV 1"	1"	1	10	560	28,840

## SUV 2

Staffa telescopica per vasi di espansione con raccordo di ottone in buste trasparenti



Cod. europeo	Cod. fabbrica	Tipo	Descrizione	Conf. (pz)	Imballo (pz)	Pallet (pz)	€/pz
9999-0755-25	075525	SUV 2	3/4" - Ottone certificato DM174	1	8	448	37,580

## SUV 3

Staffa telescopica per vasi di espansione con raccordo di ottone in buste trasparenti



Cod. europeo	Cod. fabbrica	Tipo	Descrizione	Conf. (pz)	Imballo (pz)	Pallet (pz)	€/pz
9999-0755-30	075530	SUV 3	3/4" - Ottone certificato DM174	1	8	448	62,740

## BA/BA S/BA 1/BA 1 S

Bandella preforata in scatola



Cod. europeo	Cod. fabbrica	Tipo	Descrizione	Conf. (m)	Imballo (conf)	Pallet (conf)	€/conf
9906-0320-01	072001	BA	20x0,8 mm	20	5	135	59,670
9906-0320-03	072003	BA S	17x0,7 mm	10	10	12000	15,390
9906-0320-06	072006	BA 1	14x0,5 mm	30	5	135	58,000
9906-0320-08	072008	BA 1 S	12x0,7 mm	10	10	12000	12,340

## GINASTRO

Nastro in tessuto in scatola



Cod. europeo	Cod. fabbrica	Tipo	Descrizione	Conf. (m)	Imballo (conf)	Pallet (conf)	€/conf
9906-0321-00	072100	GINASTRO	Nastro 25x1 mm	20	14	378	23,600

## CC

Chiodo fissaggio bandella in scatola

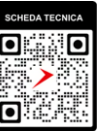

Cod. europeo	Cod. fabbrica	Tipo	Descrizione	Conf. (pz)	Imballo (pz)	Pallet (pz)	€/pz
9906-0320-30	072030	CC 18	Ø 4x18 mm	200	2000	200.000	0,110
9906-0320-31	072031	CC 22	Ø 4x22 mm	200	2000	200.000	0,130

## PCC

Punzone per chiodi in scatola

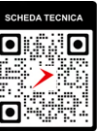

Cod. europeo	Cod. fabbrica	Tipo	Conf. (pz)	Imballo (pz)	Pallet (pz)	€/pz
9906-0320-90	072090	PCC	-	5	600	64,870

## SBA

Supporto per bandella in buste trasparenti



Cod. europeo	Cod. fabbrica	Tipo	Conf. (pz)	Imballo (pz)	Pallet (pz)	€/pz
9906-0320-10	072010	SBA	1	100	5600	2,000

## STRIP

Striscia perforata  
in barre



Cod. europeo	Cod. fabbrica	Tipo	Descrizione	Conf. (pz)	Imballo (pz)	Pallet (pz)	€/pz
9906-0540-00	074000	STRIP	1,98 mt Sezione 40x3 mm	-	10	10	45,770

## ASC

Supporto fissaggio scarico  
in buste trasparenti



Cod. europeo	Cod. fabbrica	Tipo	Descrizione	Conf. (pz)	Imballo (pz)	Pallet (pz)	€/pz
9906-0540-12	074012	ASC	Per STRIP	1	25	3000	4,250

## PIASTRINA

Fissaggio gomiti flangiati  
in buste trasparenti



Cod. europeo	Cod. fabbrica	Tipo	Descrizione	Conf. (pz)	Imballo (pz)	Pallet (pz)	€/pz
9906-0540-10	074010	PIASTRINA	Per STRIP	2	50	2800	4,800

## UTS

Utensile di piega per bandella  
in scatola



Cod. europeo	Cod. fabbrica	Tipo	Descrizione	Conf. (pz)	Imballo (pz)	Pallet (pz)	€/pz
9906-0540-30	074030	UTS	Per STRIP	-	5	600	65,650

## VALIGETTA

Kit per STRIP  
in scatola



Cod. europeo	Cod. fabbrica	Tipo	Descrizione	Conf. (pz)	Imballo (pz)	Pallet (pz)	€/pz
9906-0501-20	000120	VALIGETTA	KIT STRIP	-	1	-	169,000

## BF

Barra filettata  
in fasci



Cod. europeo	Cod. fabbrica	Tipo	Dimensioni (mm)	Barra (m)	Imballo (pz)	Pallet (pz)	€/pz
9906-0749-00	264900	BF/6	M6X1000	1	10	10	1,450
9906-0750-00	265000	BF/8	M8X1000	1	10	10	2,220
9906-0750-02	265002	BF2/8	M8X2000	2	1	1	4,650
9906-0751-00	265100	BF/10	M10X1000	1	10	10	3,290
9906-0751-02	265102	BF2/10	M10X2000	2	1	1	6,860
9906-0752-00	265200	BF/12	M12X1000	1	10	10	4,930
9906-0753-00	265300	BF/14	M14X1000	1	10	10	6,310
9906-0754-00	265400	BF/16	M16X1000	1	10	10	8,370
9906-0755-00	265500	BF/18	M18X1000	1	5	5	11,700
9906-0756-00	265600	BF/20	M20X1000	1	5	5	13,570

## BFT

Tubo filettato  
in fasci



Cod. europeo	Cod. fabbrica	Tipo	Descrizione	Conf. (pz)	Imballo (pz)	Pallet (pz)	€/pz
9906-0760-00	266000	BFT 1/2"	1/2"x1000	1	5	5	40,580

## CBF

Avvitatore per barre e perni filettati  
in scatola



Cod. europeo	Cod. fabbrica	Tipo	Descrizione	Conf. (pz)	Imballo (pz)	Pallet (pz)	€/pz
9906-1910-00	261000	CBF	M6xM8xM10xM12	-	10	1200	54,000

## AN

Manicotto di connessione barre filettate  
in buste trasparenti



Cod. europeo	Cod. fabbrica	Tipo	Descrizione	Conf. (pz)	Imballo (pz)	Pallet (pz)	€/pz
9906-0932-10	163210	AN 6	M6x25	10	200	24000	1,770
9906-0933-10	163310	AN 8	M8x25	10	200	24000	1,770
9906-0935-10	163510	AN 10	M10x30	10	200	24000	2,270
9906-0936-10	163610	AN 12	M12x35	10	100	12000	3,480

## ANR

Manicotto di riduzione  
in scatola



Cod. europeo	Cod. fabbrica	Tipo	Descrizione	Conf. (pz)	Imballo (pz)	Pallet (pz)	€/pz
9906-0932-50	163250	ANR	M6xM8xM10x30	50	200	24000	3,860

## CAT

Catena genovese  
in scatola



Cod. europeo	Cod. fabbrica	Tipo	Descrizione	Conf. (pz)	Imballo (pz)	Pallet (pz)	€/pz
9906-1902-00	270200	CAT 2	Spessore 2,2 mm	20	120	6720	4,010
9906-1903-00	270300	CAT 3	Spessore 3 mm	20	60	1620	5,720

## GA 5

Gancio a "S" per catena  
in buste trasparenti



Cod. europeo	Cod. fabbrica	Tipo	Descrizione	Conf. (pz)	Imballo (pz)	Pallet (pz)	€/pz
9906-1910-50	271050	GA 5	Spessore 5 mm	5	300	36000	0,830

## TEN 6

Tenditore per catena  
in scatola



Cod. europeo	Cod. fabbrica	Tipo	Descrizione	Conf. (pz)	Imballo (pz)	Pallet (pz)	€/pz
9906-1920-60	272060	TEN 6	Escursione 130-180	-	100	12000	5,810

## PT

Porta etichette con fascetta  
in buste trasparenti



Cod. europeo	Cod. fabbrica	Tipo	Conf. (pz)	Imballo (pz)	Pallet (pz)	€/pz
9906-1250-00	025000	PT	1	20	1120	9,890

## PTP

Porta etichetta con perno  
in buste trasparenti



Cod. europeo	Cod. fabbrica	Tipo	Conf. (pz)	Imballo (pz)	Pallet (pz)	€/pz
9906-1250-10	025010	PTP	1	20	1120	5,690

## FAS

Fascetta di prolunga  
in buste trasparenti



Cod. europeo	Cod. fabbrica	Tipo	Conf. (pz)	Imballo (pz)	Pallet (pz)	€/pz
9906-1250-50	025050	FAS	1	50	2800	6,940

## ET

Fogli etichette adesive  
in scatola



Cod. europeo	Cod. fabbrica	Tipo	Descrizione	Conf. (pz)	Imballo (pz)	Pallet (pz)	€/pz
9906-1251-00	025100	ETCA	Andata Riscaldamento	10	20	-	3,360
9906-1251-01	025101	ETCR	Ritorno Riscaldamento	10	20	-	3,360
9906-1251-02	025102	ETCF	Acqua Fredda	10	20	-	3,360
9906-1251-03	025103	ETCC	Acqua Calda	10	20	-	3,360
9906-1251-04	025104	ETCG	Gas	10	20	-	3,360
9906-1251-05	025105	ETCS	Altri fluidi	10	20	-	3,360
9906-1251-50	025150	ET B	-	10	50	-	1,950

## 5. ANCORANTI E SIGILLANTI

La gamma di ancoranti e sigillanti di GIA è ampia e adatta a molteplici materiali e applicazioni, dal settore civile a quello industriale. Comprende ancoranti chimici certificati e sigillanti silconici professionali.

Tra i prodotti principali:

- Giolli, tassello plastico a spina elastica storico;
- G-Tech, ancorante universale con espansione in sei direzioni;
- X-Tech, ancorante bi-materiale per cartongesso.

SCOPRI DI PIÙ,  
INQUADRA IL  
QR CODE



Completano la gamma ancoranti meccanici certificati, inclusi quelli antisismici, per prestazioni affidabili e sicurezza nelle installazioni.



## Ancoranti leggeri plastici



### GIOLLI

Ancorante universale a spina elastica per fissaggi su muratura e calcestruzzo. Particolarmente idoneo in mattoni forati e pareti vuote grazie alle alette di espansione. Realizzato in Polipropilene.



### G-TECH

Ancorante universale per fissaggi su muratura, cartongesso e calcestruzzo. Particolarmente idoneo in mattoni forati e pareti vuote grazie alle alette di espansione. Realizzato in Poliammide 6. Ancoraggi efficaci su ogni tipo di muratura grazie alla sua particolare sagomatura che permette l'espansione in 6 direzioni differenti. Dotato di collarino dinamico che permette sia una posa a filo parete sia un montaggio passante.

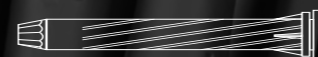

### X-TECH

Ancorante esclusivo per fissaggi su cartongesso, sia su singola che su doppia lastra. Tecnologia ad annodamento: annoda nelle cavità dei supporti per un fissaggio sicuro. Ancorante bi-materiale: corpo d'espansione in poliammide con alette antirotazione e boccola dicentraggio vite; cono d'espansione in tecnopolimero fibro-rinforzato, con filettatura metrica. Ampia rosa di appoggio antistrappo per una tenuta eccellente.

## SIL

Sigillanti siliconici antimuffa ad elevate prestazioni in scatola



Cod. europeo	Cod. fabbrica	Tipo	Descrizione	Conf. (pz)	Imballo (pz)	Pallet (pz)	€/pz
9905-1952-00	155200	SIL-AT	Acetico trasparente 280 ml	-	24	1440	7,570
9905-1952-20	155220	SIL-AB	Acetico bianco 280 ml	-	24	1440	7,570
9905-1952-40	155240	SIL-NT	Neutro prof. trasparente 280 ml	-	24	1440	11,680
9905-1952-60	155260	SIL-NB	Neutro prof. bianco 280 ml	-	24	1440	11,680
9905-1952-80	155280	SIL-HT	Alte temperature nero 310 ml	-	12	936	18,250

## SIL-BC

Beccucci per cartucce sigillanti siliconici in scatola



Cod. europeo	Cod. fabbrica	Tipo	Descrizione	Conf. (pz)	Imballo (pz)	Pallet (pz)	€/pz
9905-1951-99	155199	SIL-BC	Beccuccio silicone	-	25	75000	0,450

## FSR 175

Filo sigilla raccordi in scatola



Cod. europeo	Cod. fabbrica	Tipo	Descrizione	Conf. (pz)	Imballo (pz)	Pallet (pz)	€/pz
9905-1955-00	155500	FSR 175	175 MT	-	12	1920	27,530

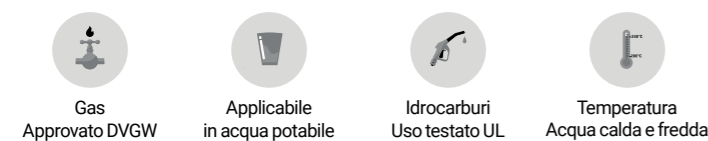

## PSF+ 300

Ancorante chimico professionale senza stirene in scatola



Cod. europeo	Cod. fabbrica	Tipo	Descrizione	Conf. (pz)	Imballo (pz)	Pallet (pz)	€/pz
2500-0039-35	51124P	PSF + 300	300ml + 1 mixer	-	12	1152	13,360



## VSF+ 300

Ancorante chimico professionale antisismico senza stirene in scatola - Articolo disponibile su richiesta



Cod. europeo	Cod. fabbrica	Tipo	Descrizione	Conf. (pz)	Imballo (pz)	Pallet (pz)	€/pz
2500-0039-36	01320	VSF + 300	300ml + 1 mixer	-	12	1152	16,220



## ACCESSORI

Accessori per l'installazione con ancorante chimico e sigillanti in scatola

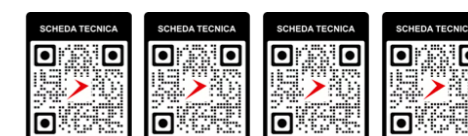

Cod. europeo	Cod. fabbrica	Tipo	Descrizione	Conf. (pz)	Imballo (pz)	Pallet (pz)	€/pz
9905-0150-75	01005G	MIXER	Mixer	-	30	5400	2,220
9905-0150-80	01009	PST	Pistola per cartucce	-	3	81	65,030
9905-0150-85	155085	S1 TCH	Scovolino grande	-	5	2500	24,420
9905-0150-86	155086	S2 TCH	Scovolino piccolo	-	10	5000	34,100
9905-0150-88	155088	PUMP TCH	Pompette pulisci foro	-	2	112	42,590

## BF 8/10/12

Barra filettata per ancorante chimico in scatola



Cod. europeo	Cod. fabbrica	Tipo	Descrizione	Conf. (pz)	Imballo (pz)	Pallet (pz)	€/pz
9905-0150-25	155025	BF 8X110	a 45° - CL.5.8	-	20	6720	2,080
9905-0150-30	155030	BF 10X110	a 45° - CL.5.8	-	20	6720	2,460
9905-0150-34	155034	BF 10X160	a 45° - CL.5.8	-	20	3600	2,850
9905-0150-40	155040	BF 12X115	a 45° - CL.5.8	-	20	6720	3,990

N.B.: Gamma in esaurimento

## R 12/15/20

Bussola retinata per ancorante chimico in scatola



Cod. europeo	Cod. fabbrica	Tipo	Descrizione	Conf. (pz)	Imballo (pz)	Pallet (pz)	€/pz
9905-0150-65	155065	R 12X80	Per barra M6-M8	-	20	6720	0,780
9905-0150-67	155067	R 15X85	Per barra M8-M10	-	20	6720	0,800
9905-0150-69	155069	R 20X85	Per barra M12	-	20	3600	1,000

## GIOLLI TN

Ancorante universale in scatola



Cod. europeo	Cod. fabbrica	Tipo	Descrizione	Conf. (pz)	Imballo (pz)	Pallet (pz)	€/pz
9903-0306-01	102001	6 TN	Ø 6x30	100	1000	56000	0,130
9903-0308-01	104001	8 TN	Ø 8x40	100	600	33600	0,190
9903-0310-01	106201	10 TN	Ø 10x70	70	560	15120	0,380
9903-0312-01	108201	12 TN	Ø 12x70	50	400	10800	0,620

giolli®

## GIOLLI TV

Giolli TN con vite TV testa svasata a croce in scatola



Cod. europeo	Cod. fabbrica	Tipo	Descrizione	Conf. (pz)	Imballo (pz)	Pallet (pz)	€/pz
9903-0306-11	134000	6 TV	Vite 4,5x35 - Giolli Ø 6	100	600	33600	0,350
9903-0308-11	138000	8 TV	Vite 6x44 - Giolli Ø 8	100	600	33600	0,550

giolli®

## GIOLLI TP

Giolli TN con vite TP testa piana taglio combinato in scatola



Cod. europeo	Cod. fabbrica	Tipo	Descrizione	Conf. (pz)	Imballo (pz)	Pallet (pz)	€/pz
9903-0306-15	134400	6 TP	Vite 4,5x35 - Giolli Ø 6	100	600	33600	0,350
9903-0308-15	138400	8 TP	Vite 6x40 - Giolli Ø 8	100	600	33600	0,590
9903-0308-16	138410	8 TP INOX	Vite 6x40 - Giolli Ø 8	10	200	24000	0,980

giolli®

## GIOLLI TB

Giolli TN con vite TB testa esagonale in scatola



Cod. europeo	Cod. fabbrica	Tipo	Descrizione	Conf. (pz)	Imballo (pz)	Pallet (pz)	€/pz
9903-0308-19	138700	8 TB	Vite 6x38 - Giolli Ø 8	100	600	33600	0,800
9903-0310-11	142700	10 TB	Vite 8x80 - Giolli Ø 10	50	300	16800	2,090
9903-0312-14	146700	12 TB	Vite 10x82 - Giolli Ø 12	25	200	5400	3,020

giolli®

## GIOLLI TG

Giolli TN con cancano TG testa a gancio in scatola



Cod. europeo	Cod. fabbrica	Tipo	Descrizione	Conf. (pz)	Imballo (pz)	Pallet (pz)	€/pz
9903-0306-13	134200	6 TG	Giolli Ø 6	100	600	33600	0,640
9903-0308-13	138200	8 TG	Giolli Ø 8	100	600	33600	0,740

giolli®

## VLM

Vitone doppio filetto in scatola



Cod. europeo	Cod. fabbrica	Tipo	Descrizione	Conf. (pz)	Imballo (pz)	Pallet (pz)	€/pz
9904-1546-90	164690	VLM 6	6x90	50	200	24000	0,530
9904-1547-00	164700	VLM 8	8x90	50	200	24000	0,630
9904-1547-01	164701	VLM 8x140	8x140	-	100	18000	1,650
9904-1547-02	164702	VLM 8x200	8x200	-	100	12000	2,110
9904-1547-10	164710	VLM 10	10x100	50	200	24000	1,110
9904-1547-11	164711	VLM 10x140	10x140	-	50	9000	2,100
9904-1547-12	164712	VLM 10x180	10x180	-	50	6000	2,180
9904-1547-13	164713	VLM 10x220	10x220	-	50	6000	2,980

## X-TECH 10X60

Ancorante ad alte prestazioni per pareti in cartongesso in scatola



Cod. europeo	Cod. fabbrica	Tipo	Descrizione	Conf. (pz)	Imballo (pz)	Pallet (pz)	€/pz
9903-0119-00	131900	X-TECH 10x60	10x60 mm - M5	25	250	14000	1,380

## X-TECH C

Ancorante ad alte prestazioni con cancano per pareti in cartongesso in scatola



Cod. europeo	Cod. fabbrica	Tipo	Descrizione	Conf. (pz)	Imballo (pz)	Pallet (pz)	€/pz
9903-0119-01	131901	X-TECH C	10x50 mm - M5	25	250	14000	1,550

## G-TECH TV

Ancorante con vite testa svasata a croce in scatola



Cod. europeo	Cod. fabbrica	Tipo	Descrizione	Conf. (pz)	Imballo (pz)	Pallet (pz)	€/pz
9903-0118-10	131810	G-TECH 6 TV	6x30 - Vite TS 4,5x40	100	100	56000	0,170
9903-0118-30	131830	G-TECH 8 TV	8x40 - Vite TS 5x50	50	500	28000	0,280
9903-0118-50	131850	G-TECH 10 TV	10x50 - Vite TS 6x60	25	250	14000	0,550

## G-TECH TB

Ancorante con vite testa esagonale in scatola



Cod. europeo	Cod. fabbrica	Tipo	Descrizione	Conf. (pz)	Imballo (pz)	Pallet (pz)	€/pz
9903-0118-35	131835	G-TECH 8 TB	8x40 - Vite TE 6x50	50	500	28000	0,660
9903-0118-55	131855	G-TECH 10 TB	10x50 - Vite TE 7x70	25	250	14000	1,090
9903-0118-75	131875	G-TECH 12 TB	12x60 - Vite TE 8x80	20	200	11200	1,420

## VP POL

Ancorante a percussione per canaline in scatola



Cod. europeo	Cod. fabbrica	Tipo	Descrizione	Conf. (pz)	Imballo (pz)	Pallet (pz)	€/pz
2500-0043-88	06747	VP POL	6x37 mm	-	200	-	0,150

## VP POL M6

Ancorante a percussione M6 MARRONE per collari in rame in scatola



Cod. europeo	Cod. fabbrica	Tipo	Descrizione	Conf. (pz)	Imballo (pz)	Pallet (pz)	€/pz
2500-0043-90	06740	VP POL M6	6x39 mm	-	200	-	0,170

## TNF

Fissaggio a martello per collari  
in busta trasparente da 2 pz/cad



Cod. europeo	Cod. fabbrica	Tipo	Descrizione	Conf. (pz)	Imballo (pz)	Pallet (pz)	€/pz
9903-0310-13	146401	10 TNF	8x90 Giolli Ø10	2	100	2700	2,040
9903-0312-12	146501	12 TNF	10x100 Giolli Ø12	2	100	2700	3,100

## TF

Fissaggio per collari  
in busta trasparente da 2 pz/cad



Cod. europeo	Cod. fabbrica	Tipo	Descrizione	Conf. (pz)	Imballo (pz)	Pallet (pz)	€/pz
9903-0310-12	146400	10 TF	8x90 - Giolli Ø10	2	100	2700	2,040
9903-0312-11	146500	12 TF	10x100 - Giolli Ø12	2	100	2700	3,100
9903-0312-13	146510	12 TF1	10x100 - Giolli Ø12	1	250	6750	1,310

\* Senza dado

## FC TECH

Fissaggio per collari  
in busta trasparente da 2 pz/cad



Cod. europeo	Cod. fabbrica	Tipo	Descrizione	Conf. (pz)	Imballo (pz)	Pallet (pz)	€/pz
9903-0118-60	131860	FC TECH M8	Vite 8x80 G TECH Ø10	2	100	-	1,630
9903-0118-65	131865	FC TECH M10	Vite 10x90 G TECH Ø12	2	100	-	2,480

## IP L

Ancorante per isolamento a cappotto  
in scatola



Cod. europeo	Cod. fabbrica	Tipo	Descrizione	Conf. (pz)	Imballo (pz)	Pallet (pz)	€/pz
9903-0603-10	120310	IP L60	Per vite 4,5 - 5	-	50	9000	1,140
9903-0603-20	120320	IP L95	Per vite 8 - M8	-	25	4500	1,790

BEST  
NYLON  
QUALITY



gia

## IP M8

Fissaggio leggero per isolamento a cappotto  
in busta trasparente



Cod. europeo	Cod. fabbrica	Tipo	Descrizione	Conf. (pz)	Imballo (pz)	Pallet (pz)	€/pz
9903-0603-50	120350	IP M8	Con barra INOX M8x70	1	30	1680	5,620

## ISO 8

Fissaggio medio per isolamento a cappotto  
in busta trasparente



Cod. europeo	Cod. fabbrica	Tipo	Descrizione	Conf. (pz)	Imballo (pz)	Pallet (pz)	€/pz
9903-0500-50	120050	ISO 8x100	Cappotti spess. 40-65 mm	1	30	1680	7,360
9903-0500-55	120055	ISO 8x140	Cappotti spess. 80-105 mm	1	30	1680	8,070

## ISO 10

Fissaggio pesante per muri con isolamento a cappotto  
in busta trasparente

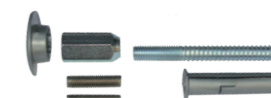

Cod. europeo	Cod. fabbrica	Tipo	Descrizione	Conf. (pz)	Imballo (pz)	Pallet (pz)	€/pz
9903-0501-00	120100	ISO 10x100	Cappotti spess. 40-65 mm	1	30	1680	9,210
9903-0501-40	120140	ISO 10x140	Cappotti spess. 80-105 mm	1	30	1680	9,950
9903-0501-80	120180	ISO 10x180	Cappotti spess. 120-145 mm	1	30	1680	10,400
9903-0502-20	120220	ISO 10x220	Cappotti spess. 160-185 mm	1	30	1680	11,390

## ISOCLIMA 12X200

Fissaggio isolante per murature con isolamento a cappotto  
in busta trasparente da 2 pz/cad



Cod. europeo	Cod. fabbrica	Tipo	Descrizione	Conf. (pz)	Imballo (pz)	Pallet (pz)	€/pz
9903-0502-25	120225	ISOCLIMA 12x200	Cappotti spessore 80-160 mm	2	10	560	48,900



gia

## PTN

Punzone per inserzione ancoranti sotto cappotto in scatola



Cod. europeo	Cod. fabbrica	Tipo	Descrizione	Conf. (pz)	Imballo (pz)	Pallet (pz)	€/pz
9903-0500-10	120010	PTN 10	Per Giolli 10 TN	-	10	5000	25,200
9903-0500-12	120012	PTN 10	Per Giolli 12 TN	-	10	5000	25,200

## TOT

Ancorante in ottone in scatola



Cod. europeo	Cod. fabbrica	Tipo	Descrizione	Conf. (pz)	Imballo (pz)	Pallet (pz)	€/pz
9904-0101-00	100100	TOT 6X24	M6 - Foro Ø8	100	400	48000	0,820
9904-0101-01	100110	TOT 8X30	M8 - Foro Ø10	100	400	48000	1,230
9904-0101-02	100120	TOT 10X35	M10 - Foro Ø12	100	400	48000	1,750
9904-0101-03	100130	TOT 12X40	M12 - Foro Ø15	50	200	24000	3,690

## TCO CE

Ancorante femmina in acciaio multiuso in scatola



Cod. europeo	Cod. fabbrica	Tipo	Descrizione	Conf. (pz)	Imballo (pz)	Pallet (pz)	€/pz
9904-0102-10	100250	TCO CE 8x30	M8x30 - Foro Ø10	-	100	300.000	0,680
9904-0102-11	100255	TCO CE 10x40	M10x40 - Foro Ø12	-	50	150.000	0,910
9904-0102-12	100260	TCO CE 12x50	M12x50 - Foro Ø15	-	25	75.000	1,490



ETAG 001-04



ETAG 001-046



Per M10 e M12



R30-R120

## PE

Punzone per ancoranti in acciaio in scatola



Cod. europeo	Cod. fabbrica	Tipo	Descrizione	Conf. (pz)	Imballo (pz)	Pallet (pz)	€/pz
9904-0112-10	261210	PE 8	Per TCO CE 8	-	1	-	29,210
9904-0112-20	261220	PE 10	Per TCO CE 10	-	1	-	29,210
9904-0112-30	261230	PE 12	Per TCO CE 12	-	1	-	29,210

## VCLS R

Vite per calcestruzzo con innesto rapido in buste trasparenti



Cod. europeo	Cod. fabbrica	Tipo	Descrizione	Conf. (pz)	Imballo (pz)	Pallet (pz)	€/pz
9904-0110-10	130010	VCLS M8 R	Foro Ø8	5	25	3000	8,690
9904-0110-20	130020	VCLS M10 R	Foro Ø8	5	25	3000	9,130

N.B.: Fino ad esaurimento scorte



Per M10 R

## VCLS

Vite antisismica per calcestruzzo con attacco femmina in buste trasparenti



Cod. europeo	Cod. fabbrica	Tipo	Descrizione	Conf. (pz)	Imballo (pz)	Pallet (pz)	€/pz
9904-0110-00	130000	VCLS M6	Foro Ø6	5	25	8400	1,500
9904-0110-01	130001	VCLS M8	Foro Ø6	5	25	8400	1,580
9904-0110-02	130002	VCLS M10	Foro Ø6	5	25	8400	1,580
9904-0110-05	130005	VCLS M8/M10	Foro Ø6	5	25	8400	1,730



ETA 17/0806



R30-R120



SEISMIC

## VTE CLS SM

Vite antisismica ad alte prestazioni per calcitrizzo in scatola



Cod. europeo	Cod. fabbrica	Tipo	Descrizione	Conf. (pz)	Imballo (pz)	Pallet (pz)	€/pz
9904-0110-51	130051	VTE CLS 8x60 SM	8x60 - Foro Ø8	-	25	8400	1,530
9904-0110-53	130053	VTE CLS 10x60 SM	10x60 Foro Ø10	-	25	8400	2,100
9904-0110-55	130055	VTE CLS 10x85 SM	10x85 Foro Ø10	-	25	8400	2,350
9904-0110-57	130057	VTE CLS 10x100 SM	10x100 Foro Ø10	-	25	8400	2,560



## TBF

Ancorante in acciaio per carichi medi in scatola



Cod. europeo	Cod. fabbrica	Tipo	Descrizione	Conf. (pz)	Imballo (pz)	Pallet (pz)	€/pz
9904-0103-05	100325	TBF 10/5-50	M8x55 Foro Ø10	-	25	75.000	1,200
9904-0103-06	100330	TBF 10/35-80	M8x80 Foro Ø10	-	20	60.000	1,410

## TLA CE

Ancorante in acciaio per carichi pesanti in scatola



Cod. europeo	Cod. fabbrica	Tipo	Descrizione	Conf. (pz)	Imballo (pz)	Pallet (pz)	€/pz
9904-0201-11	130111	TLA CE 8/15-80	M8 - Foro Ø8	-	25	75.000	0,960
9904-0201-14	130114	TLA CE 8/50-115	M8 - Foro Ø8	-	15	45.000	1,070
9904-0201-21	130121	TLA CE 10/15-90	M10 - Foro Ø10	-	20	60.000	1,210
9904-0201-24	130124	TLA CE 10/45-120	M10 - Foro Ø10	-	10	30.000	1,470
9904-0201-31	130131	TLA CE 12/10-90	M12 - Foro Ø12	-	15	45.000	1,830
9904-0201-34	130134	TLA CE 12/45-140	M12 - Foro Ø12	-	12	4.032	2,350



## TLA SM

Ancorante antisismico C1-C2 in scatola



Cod. europeo	Cod. fabbrica	Tipo	Descrizione	Conf. (pz)	Imballo (pz)	Pallet (pz)	€/pz
9904-0201-62	130162	TLA SM 8X80	M8 - Foro Ø8	-	100	33.600	1,800
9904-0201-64	130164	TLA SM 8X95	M8 - Foro Ø8	-	100	33.600	2,130
9904-0201-72	130172	TLA SM 10X90	M10 - Foro Ø10	-	50	16.800	2,540
9904-0201-74	130174	TLA SM 10X110	M10 - Foro Ø10	-	50	16.800	3,100
9904-0201-82	130182	TLA SM 12X105	M12 - Foro Ø12	-	25	8.400	3,570
9904-0201-84	130184	TLA SM 12X125	M12 - Foro Ø12	-	25	8.400	4,440



EAD 330232-00-0601

## TOP G

Ancoraggio in acciaio per carichi medi con gancio in scatola



Cod. europeo	Cod. fabbrica	Tipo	Descrizione	Conf. (pz)	Imballo (pz)	Pallet (pz)	€/pz
9904-0105-01	130280	TOP 8 G	M8x60 - Foro Ø12	-	12	36.000	2,970
9904-0105-10	130290	TOP 10 G	M10x73 - Foro Ø14	-	6	18.000	4,370

## TOP CE VTE

Ancorante in acciaio per carichi pesanti con vite in scatola



Cod. europeo	Cod. fabbrica	Tipo	Descrizione	Conf. (pz)	Imballo (pz)	Pallet (pz)	€/pz
9904-0105-02	130310	TOP 8 CE VTE	M8x65 - Foro Ø12	-	25	75.000	1,910
9904-0105-11	130320	TOP 10 CE VTE	M10x80 - Foro Ø14	-	15	45.000	2,990
9904-0105-21	130330	TOP 12 CE VTE	M12x100 - Foro Ø18	-	10	30.000	4,060



ETAG 001-02



## OC/DD/AS

Ancorine per fissaggio a soffitto in scatola



Cod. europeo	Cod. fabbrica	Tipo	Descrizione	Conf. (pz)	Imballo (pz)	Pallet (pz)	€/pz
9904-0111-04	131210	OC 6	M6 - Foro Ø16	-	15	5.040	2,850
9904-0111-06	131230	DD 6	M6 - Foro Ø16	-	15	5.040	2,850
9904-0111-07	131235	AS 8	M8 - Foro Ø20	-	25	75.000	4,180
9904-0111-08	131240	DD8	M8 - Foro Ø20	-	10	3.360	5,720
9904-0111-09	131250	DD10	M10 - Foro Ø22	-	10	3.600	7,500

## G-TECH TV

Barattolo ancoranti Nylon con vite testa svasata a croce



Cod. europeo	Cod. fabbrica	Tipo	Descrizione	Conf. (pz)	Imballo (conf)	Pallet (conf)	€/conf
9903-0118-11	131811	G-TECH 6 TV	6x30 - Vite TS 4,5x40	300	6	144	45,780
9903-0118-31	131831	G-TECH 8 TV	8x40 - Vite TS 5x50	200	6	144	47,380

## GIOLLI TN

Giolli TN in blister



Cod. europeo	Cod. fabbrica	Tipo	Descrizione	Conf. (pz)	Imballo (conf)	Pallet (conf)	€/conf
9903-0920-01	302001	6 TNs	Foro Ø6	30	10	1800	4,590
9903-0940-01	304001	8 TNs	Foro Ø8	20	10	1800	4,590
9903-0962-01	306201	10 TNs	Foro Ø10	10	10	1800	4,590
9903-0982-01	308201	12 TNs	Foro Ø12	6	10	1800	4,590

## GIOLLI TV

Giolli e vite TV in blister



Cod. europeo	Cod. fabbrica	Tipo	Descrizione	Conf. (pz)	Imballo (conf)	Pallet (conf)	€/conf
9903-0905-00	332000	5 TVs	Foro Ø5	25+25	10	1800	7,780
9903-0906-00	334000	6 TVs	Foro Ø6	20+20	10	1800	7,780
9903-0908-00	338000	8 TVs	Foro Ø8	13+13	10	1800	7,780

## GIOLLI TP

Giolli e vite TP in blister



Cod. europeo	Cod. fabbrica	Tipo	Descrizione	Conf. (pz)	Imballo (conf)	Pallet (conf)	€/conf
9903-0906-01	334400	6 TPs	Foro Ø6	20+20	10	1800	7,780
9903-0908-02	338400	8 TPs	Foro Ø8	13+13	10	1800	7,930
9903-0908-03	338410	8 TPXs	Foro Ø8	13+13	10	1800	14,540

## GIOLLI TB

Giolli e vite TB in blister



Cod. europeo	Cod. fabbrica	Tipo	Descrizione	Conf. (pz)	Imballo (conf)	Pallet (conf)	€/conf
9903-0908-04	338700	8 TBs	Foro Ø8	10+10	10	1800	8,120
9903-0908-05	338710	8 TBXs	Foro Ø8	8+8	10	1800	14,540
9903-0910-00	342700	10 TBs	Foro Ø10	4+4	10	1800	8,450
9903-0912-00	346700	12 TBs	Foro Ø12	2+2	10	1800	7,780

## GIOLLI TG

Giolli e cancano TG in blister



Cod. europeo	Cod. fabbrica	Tipo	Descrizione	Conf. (pz)	Imballo (conf)	Pallet (conf)	€/conf
9903-0908-01	338200	8 TGs	Foro Ø8	10+10	10	1800	7,780

## TLA

Ancoranti in acciaio in blister



Cod. europeo	Cod. fabbrica	Tipo	Descrizione	Conf. (pz)	Imballo (conf)	Pallet (conf)	€/conf
9903-0901-12	330112	TLA 8X75s	Foro Ø8	5	10	1800	14,890
9903-0901-22	330122	TLA 10X80s	Foro Ø10	4	10	1800	14,890
9903-0901-23	330123	TLA 10X100s	Foro Ø10	3	10	1800	14,890

N.B.: Gamma in esaurimento, graduale sostituzione con analoghi "TLA CE"

## TOT

Ancoranti in ottone in blister



Cod. europeo	Cod. fabbrica	Tipo	Descrizione	Conf. (pz)	Imballo (conf)	Pallet (conf)	€/conf
9903-0901-10	300110	TOT 8s	Foro Ø10	15	10	1800	21,520
9903-0901-20	300120	TOT 10s	Foro Ø12	10	10	1800	21,520

**SIMPLIFY  
YOUR  
WORK**

# 6. SISTEMI DI FISSAGGIO INDUSTRIALE

I sistemi di staffaggio industriale GIA rappresentano uno dei pilastri dell'offerta aziendale e hanno contribuito nel tempo a definire l'identità del marchio nel settore termoidraulico. Tra gli articoli più rappresentativi spicca la "Barra GIA", un prodotto divenuto un autentico riferimento per gli installatori. Il nome, nato spontaneamente dall'uso quotidiano dei professionisti, testimonia decenni di impiego e chilometri di profili installati, confermandone il ruolo emblematico.

L'offerta si articola in due famiglie principali:

- Sistema leggero Grip, progettato per applicazioni con carichi contenuti o medi, versatile e rapido da installare.
- Sistema pesante G-Strut, robusto e performante, disponibile in profilati di varie sezioni e spessori, con connessioni rapide che consentono assemblaggi sicuri e veloci anche in installazioni industriali complesse.

A completamento della gamma, GIA propone staffe e accessori antisismici certificati, garantendo sicurezza, modularità e facilità d'uso in ogni contesto impiantistico.

SCOPRI DI PIÙ,  
INQUADRA IL  
QR CODE



## Profili GRIP

Sistema di staffaggio leggero.

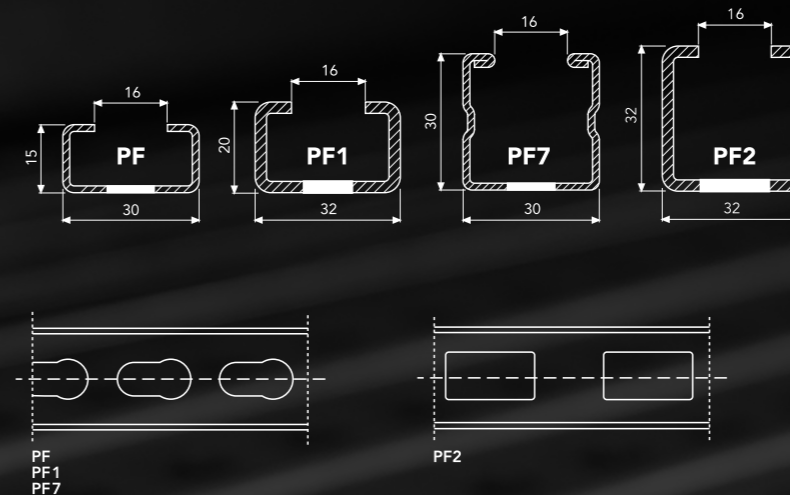

## Profili G-STRUT

Sistema di staffaggio pesante.

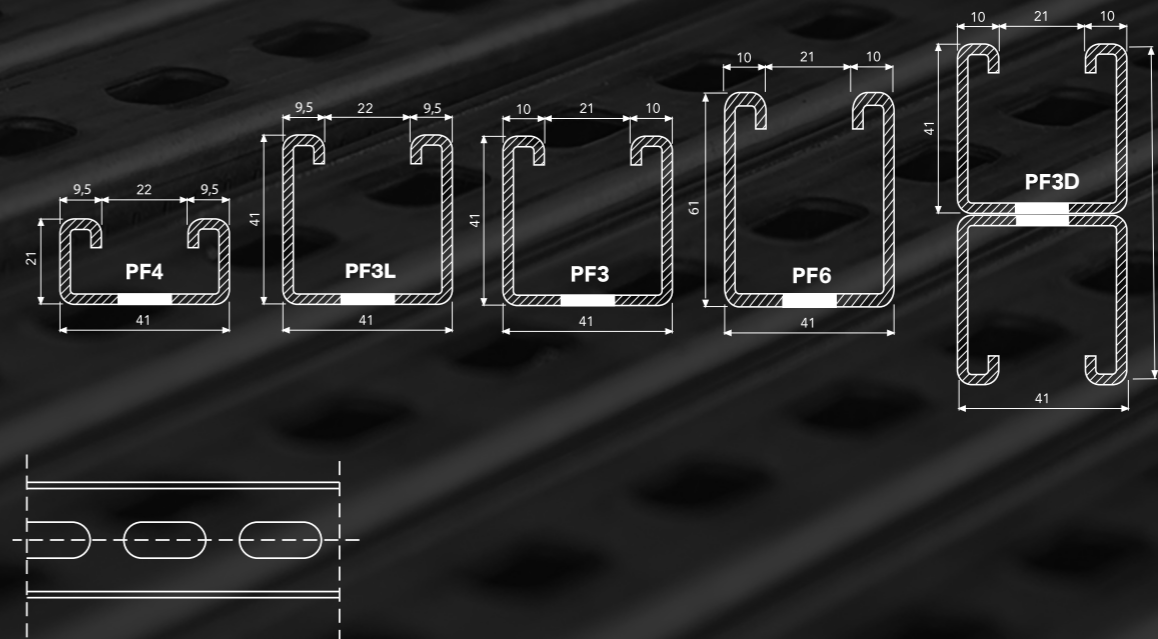

# SISTEMA LEGGERO GRIP

## PF - PF1 - PF7 GRIP

Profilo GRIP  
in barre

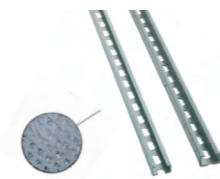

Cod. europeo	Cod. fabbrica	Tipo	Descrizione	Conf. (pz)	Imballo (pz)	Pallet (pz)	€/pz
9909-0100-06	160006	PF GRIP	30x15x1,5 - 2mt	-	10	100	17,570
9909-0101-06	160106	PF 1 GRIP	32x20x2,5 - 2mt	-	10	50	28,230
9909-0101-08	160108	PF 7 GRIP	30x30x1,5 - 2mt	-	50	50	31,480

## PF2 GRIP

Profilo GRIP medio  
in barre

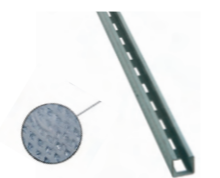

Cod. europeo	Cod. fabbrica	Tipo	Descrizione	Conf. (pz)	Imballo (pz)	Pallet (pz)	€/pz
9909-0102-00	160200	PF 2 GRIP	32x32x2,5 - 2mt	-	8	48	45,320

## PA 30 GRIP

Mensola in profilo GRIP  
in scatola

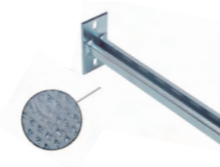

Cod. europeo	Cod. fabbrica	Tipo	Descrizione	Conf. (pz)	Imballo (pz)	Pallet (pz)	€/pz
9909-0312-20	161220	PA 30 GRIP	285 mm - PF1	-	10	560	12,340

## PA 40 GRIP

Mensola in profilo GRIP medio  
in scatola

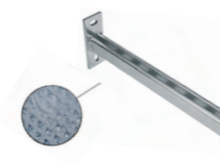

Cod. europeo	Cod. fabbrica	Tipo	Descrizione	Conf. (pz)	Imballo (pz)	Pallet (pz)	€/pz
9999-1612-25	161225	PA 40 GRIP	400 mm - PF2	-	10	240	24,940

## PA

Supporto profilo  
in scatola



Cod. europeo	Cod. fabbrica	Tipo	Descrizione	Conf. (pz)	Imballo (pz)	Pallet (pz)	€/pz
9909-0312-00	161200	PA	PF - PF1 - PF7	-	10	1200	11,330

## PA2

Supporto profilo medio  
in scatola



Cod. europeo	Cod. fabbrica	Tipo	Descrizione	Conf. (pz)	Imballo (pz)	Pallet (pz)	€/pz
9909-0312-02	161202	PA2	PF2	-	10	560	19,200

## SAT GRIP

Mensola a squadra in profilo GRIP  
in scatola

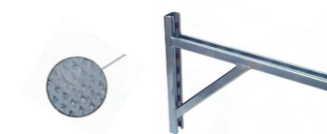

Cod. europeo	Cod. fabbrica	Tipo	Descrizione	Conf. (pz)	Imballo (pz)	Pallet (pz)	€/pz
9909-0412-55	161255	SAT GRIP	370 mm - PF1	-	10	240	27,390
9909-0412-65	161265	SAT 1 GRIP	545 mm - PF1	-	10	160	33,710

## SAT BIANCA

Mensola a squadra in profilo verniciato  
in scatola

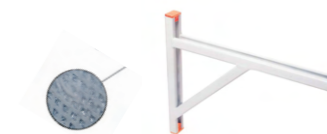

Cod. europeo	Cod. fabbrica	Tipo	Descrizione	Conf. (pz)	Imballo (pz)	Pallet (pz)	€/pz
9909-0412-56	161256	SAT BIANCA	370 mm - PF1	-	10	240	42,850
9909-0412-66	161266	SAT 1 BIANCA	545 mm - PF1	-	10	160	50,350

## SAT 2 GRIP

Mensola a squadra lunga in profilo GRIP in scatola



Cod. europeo	Cod. fabbrica	Tipo	Descrizione	Conf. (pz)	Imballo (pz)	Pallet (pz)	€/pz
9909-0412-70	161270	SAT 2 GRIP	880 mm - PF2	-	1	-	94,150

## JDR GRIP

Dado a rombo GRIP ad innesto rapido in scatola



Cod. europeo	Cod. fabbrica	Tipo	Descrizione	Conf. (pz)	Imballo (pz)	Pallet (pz)	€/pz
9909-0619-01	161901	JDR 8 GRIP	M8	25	250	14000	2,120
9909-0619-02	161902	JDR 10 GRIP	M10	25	250	14000	2,120

## JDM GRIP

Fissaggio GRIP ad innesto rapido in scatola



Cod. europeo	Cod. fabbrica	Tipo	Descrizione	Conf. (pz)	Imballo (pz)	Pallet (pz)	€/pz
9909-0619-20	161920	JDM 8X30 GRIP	M8x30 mm	25	250	14000	2,670
9909-0619-22	161922	JDM 8X70 GRIP	M8x70 mm	10	100	5600	2,920
9909-0619-30	161930	JDM 10X30 GRIP	M10x30 mm	25	250	14000	2,780
9909-0619-32	161932	JDM 10X70 GRIP	M10x70 mm	10	100	5600	3,270

## DR GRIP

Dado a rombo GRIP per profili leggeri in buste trasparenti

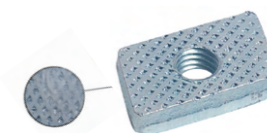

Cod. europeo	Cod. fabbrica	Tipo	Descrizione	Conf. (pz)	Imballo (pz)	Pallet (pz)	€/pz
9909-0720-01	162001	DR 6 GRIP	M6	10	250	30.000	0,990
9909-0721-01	162101	DR 8 GRIP	M8	10	500	60.000	0,990
9909-0722-01	162201	DR 10 GRIP	M10	10	500	60.000	1,110

## RO GRIP

Rondella GRIP in buste trasparenti



Cod. europeo	Cod. fabbrica	Tipo	Descrizione	Conf. (pz)	Imballo (pz)	Pallet (pz)	€/pz
9909-0840-00	164000	RO 6 GRIP	24x6,5x2,0	10	500	60.000	0,220
9909-0841-02	164102	RO 8 GRIP	30x9,0x2,5	10	500	60.000	0,380
9909-0842-00	164200	RO 10 GRIP	30x11x2,5	10	500	60.000	0,380
9909-0842-50	164250	RO 12 GRIP	27x13x2,5	10	500	60.000	0,380

## TR

Tronchetto filettato in buste trasparenti



Cod. europeo	Cod. fabbrica	Tipo	Descrizione	Conf. (pz)	Imballo (pz)	Pallet (pz)	€/pz
9909-5032-00	163200	TR 6	M6x32	10	500	30.000	0,210
9909-5033-00	163300	TR 8	M8x32	10	500	60.000	0,220
9909-5035-00	163500	TR 10	M10x32	10	500	60.000	0,330
9909-5033-05	163305	TR 8x70	M8x70	10	250	30.000	0,330
9909-5035-05	163505	TR 10x70	M10x70	10	250	30.000	0,450
9909-5036-05	163605	TR 12x115	M12x115	5	50	6.000	1,160

## BU

Bullone flangiato  
in buste trasparenti



Cod. europeo	Cod. fabbrica	Tipo	Descrizione	Conf. (pz)	Imballo (pz)	Pallet (pz)	€/pz
9909-5045-00	164500	BU 8	M8x14	10	500	60.000	0,360
9909-5045-03	164503	BU 8x20	M8x20	10	100	33.600	0,500
9909-5045-11	164511	BU 10	M10x16	10	300	36.000	0,770
9909-5045-13	164513	BU 10x25	M10x25	10	100	18.000	0,920

## DM

Bullone testa a martello per profili leggeri  
in buste trasparenti



Cod. europeo	Cod. fabbrica	Tipo	Descrizione	Conf. (pz)	Imballo (pz)	Pallet (pz)	€/pz
9909-0922-90	162290	DM 08	M8x30 mm	10	200	24.000	3,030
9909-0923-00	162300	DM 10	M10x30 mm	10	200	24.000	3,040
9909-0923-10	162310	DM 12	M12x30 mm	10	200	24.000	3,610

## D

Dado esagonale  
in buste trasparenti

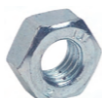

Cod. europeo	Cod. fabbrica	Tipo	Descrizione	Conf. (pz)	Imballo (pz)	Pallet (pz)	€/pz
9909-0825-00	162500	D 6	M6	10	500	60.000	0,110
9909-0826-00	162600	D 8	M8	10	500	60.000	0,160
9909-0827-00	162700	D 10	M10	10	500	60.000	0,230
9909-0827-50	162750	D 12	M12	10	400	48.000	0,360
9909-0828-00	162800	D 14	M14	8	160	19.200	0,550
9909-0828-01	162801	D 16	M16	8	160	19.200	0,660
9909-0828-02	162802	D 18	M18	8	160	19.200	0,930
9909-0828-03	162803	D 20	M20	8	160	19.200	1,210

## ANG 90 GRIP - ANG 45 GRIP

Angolare GRIP per profili leggeri con passaggio asola M8  
in scatola

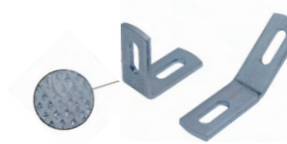

Cod. europeo	Cod. fabbrica	Tipo	Descrizione	Conf. (pz)	Imballo (pz)	Pallet (pz)	€/pz
9909-1110-01	161001	ANG 90 GRIP	26x5 - M8	10	100	5600	3,750
9909-1111-01	161101	ANG 45 GRIP	26x5 - M8	10	100	5600	3,750

## ANG P 90 GRIP - ANG P 45 GRIP

Angolare pesante GRIP per profili leggeri con  
passaggio asola M8.M10 - in scatola



Cod. europeo	Cod. fabbrica	Tipo	Descrizione	Conf. (pz)	Imballo (pz)	Pallet (pz)	€/pz
9909-1110-11	161011	ANG P 90 GRIP	30x6 - M8/M10	10	50	2800	5,330
9909-1111-11	161111	ANG P 45 GRIP	30x6 - M8/M10	10	50	2800	5,370

## CON

Congiunzione per profili leggeri  
in buste trasparenti



Cod. europeo	Cod. fabbrica	Tipo	Descrizione	Conf. (pz)	Imballo (pz)	Pallet (pz)	€/pz
9909-5024-00	162400	CON	PF/PF1/PF2/PF7	1	20	2400	9,490

## TRI

Supporto a squadra  
in scatola



Cod. europeo	Cod. fabbrica	Tipo	Descrizione	Conf. (pz)	Imballo (pz)	Pallet (pz)	€/pz
9909-0313-00	161300	TRI	183x183x4 PF/PF1/PF2/PF7	-	10	560	40,330

# PROFILI GRIP

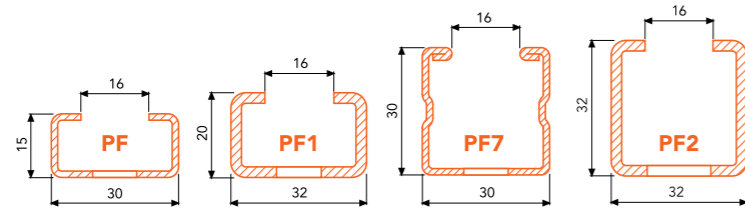

PROFILATO	SPESSORE mm.	PESO Kg./m.	SEZIONE cm <sup>2</sup>	Valori statici riferiti agli assi neutri				PF		PF1		PF7		PF2	
				Jx cm <sup>4</sup>	Jy cm <sup>4</sup>	Wx cm <sup>3</sup>	Wy cm <sup>3</sup>	A	B	C	E	A	B	C	E
PF	1,5	0,69	0,975	0,27	1,34	0,31	0,89	23	10,5	35	12,5				
PF1	2,5	1,33	1,854	0,86	2,89	0,76	1,81	23	10,5	35	12,5				
PF7	1,5	1,12	1,540	1,71	2,44	1,10	1,63	23	10,5	35	12,5				
PF2	2,5	1,79	2,478	2,69	4,17	1,61	2,61	28	15	50	-				

## CARICHI AMMISSIBILI

Materiale: acciaio al carbonio DX 51 D  
 Asse prove x-x  
 Perfetto ritorno elastico  
 Carico di sicurezza 140 N/mm<sup>2</sup> (14 Kg./mm<sup>2</sup>)

F = carico concentrato in daN  
 Q = carico uniformemente distribuito in daN/m  
 La freccia non supera L/250

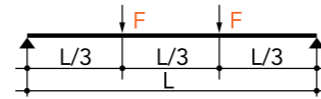
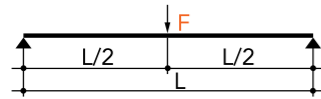

L= mm	500	1000	1500	2000	2500	3000
PF	35	11	4	-	-	-
PF1	85	34	15	8	-	-
PF7	120	60	30	15	-	-
PF2	175	87	47	25	-	-

L= mm	500	1000	1500	2000	2500	3000
PF	25	6	2	-	-	-
PF1	63	20	8	4	-	-
PF7	90	38	15	8	-	-
PF2	132	60	25	14	-	-

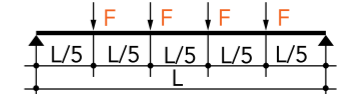
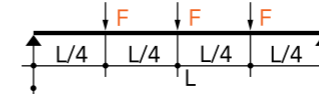

L= mm	500	1000	1500	2000	2500	3000
PF	16	4	-	-	-	-
PF1	42	13	5	2	-	-
PF7	60	28	10	5	-	-
PF2	85	43	18	8	-	-

L= mm	500	1000	1500	2000	2500	3000
PF	12	3	-	-	-	-
PF1	35	10	4	-	-	-
PF7	50	20	8	5	-	-
PF2	73	32	15	8	-	-

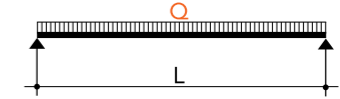
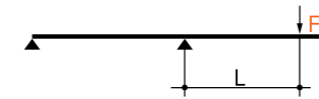

L= mm	500	1000	1500	2000	2500	3000
PF	15	8	3			
PF1	50	15	8	4		
PF7	65	20	13	5	4	
PF2	70	25	15	7	5	3

L= mm	500	1000	1500	2000	2500	3000
PF	64	15	5	2	-	-
PF1	160	53	16	7	-	-
PF7	235	100	32	14	-	-
PF2	340	165	51	21	-	-

# SISTEMA PESANTE G-STRUT

## PF4

Profilo pesante G-STRUT  
in barre



Cod. europeo	Cod. fabbrica	Tipo	Descrizione	Conf. (pz)	Imballo (pz)	Pallet (pz)	€/pz
9909-3004-00	160400	PF 4 MT3	41x21x2 - Barra 3mt	-	6	30	40,750

## PF3

Profilo pesante G-STRUT  
in barre



Cod. europeo	Cod. fabbrica	Tipo	Descrizione	Conf. (pz)	Imballo (pz)	Pallet (pz)	€/pz
9909-3003-02	160302	PF3L MT3	41x41x2 - Barra 3 mt	-	30	30	51,400
9909-3003-05	160305	PF 3 MT3	41x41x2,5 - Barra 3 mt	-	6	30	70,200
9909-3003-06	160306	PF 3 MT6	41x41x2,5 - Barra 6 mt	-	1	1	143,600

\* Prezzo unitario franco partenza (Spese di trasporto da concordare)

## PF6 - PF3D

Profili pesanti G-STRUT  
in barre

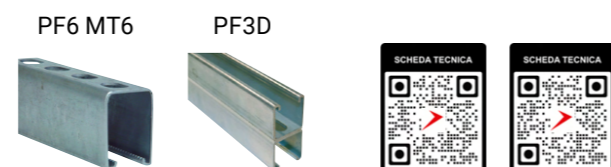

Cod. europeo	Cod. fabbrica	Tipo	Descrizione	Conf. (pz)	Imballo (pz)	Pallet (pz)	€/pz
9909-3006-00	160600	PF6 MT6	41x61x2,5 - Barra 6 mt	-	1	1	205,500
9909-3008-00	160800	PF3D MT6	41x82x2,5 - Barra 6 mt	-	1	1	375,600

Prodotto disponibile su richiesta. Tempi di consegna da concordare.  
Prezzo unitario franco partenza (Spese di trasporto da concordare)



gia

## PAP

Mensola in profilo pesante  
in scatola



Cod. europeo	Cod. fabbrica	Tipo	Descrizione	Conf. (pz)	Imballo (pz)	Pallet (pz)	€/pz
9909-3312-28	161228	PAP 30	300 mm - PF3	-	10	270	19,380
9909-3312-29	161229	PAP 40	400 mm - PF3	-	10	240	23,740
9909-3312-30	161230	PAP 50	500 mm - PF3	-	6	144	39,250
9909-3312-33	161233	PAP 75	750 mm - PF3	-	1	1	47,830
9909-3312-35	161235	PAP 100	1000 mm - PF3	-	1	1	62,940

## PAB S

Piastra base a due fori  
in scatola



Cod. europeo	Cod. fabbrica	Tipo	Descrizione	Conf. (pz)	Imballo (pz)	Pallet (pz)	€/pz
9909-3612-15	161215	PAB S	2 fori - PF3/PF3L/PF4	-	10	560	15,400

## PAP S

Piastra base a sei fori  
in scatola



Cod. europeo	Cod. fabbrica	Tipo	Descrizione	Conf. (pz)	Imballo (pz)	Pallet (pz)	€/pz
9909-3612-08	161208	PAP S	6 fori - PF3/PF3L/PF6	-	5	280	39,050



gia

## PAPD S

Piastra base a sei fori  
in scatola



Cod. europeo	Cod. fabbrica	Tipo	Descrizione	Conf. (pz)	Imballo (pz)	Pallet (pz)	€/pz
9909-3612-09	161209	PAPD S	6 fori - PF3D	-	1	-	68,900

\* Prodotto disponibile su richiesta. Tempi di consegna da concordare.

## PAP

Supporto per profilo pesante  
in scatola

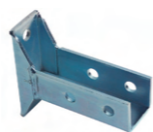

Cod. europeo	Cod. fabbrica	Tipo	Descrizione	Conf. (pz)	Imballo (pz)	Pallet (pz)	€/pz
9909-3312-05	161205	PAP	PF3/PF3L	-	10	560	31,370

## PA 3

Base per profilo pesante  
in scatola

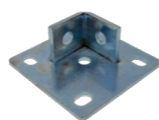

Cod. europeo	Cod. fabbrica	Tipo	Descrizione	Conf. (pz)	Imballo (pz)	Pallet (pz)	€/pz
9909-4212-10	161210	PA 3	PF3/PF3L/PF4	-	10	1200	18,600

## PN 300/600

Puntone di rinforzo  
in scatola



Cod. europeo	Cod. fabbrica	Tipo	Descrizione	Conf. (pz)	Imballo (pz)	Pallet (pz)	€/pz
9909-3710-60	161060	PN 300	300 mm - PAP 40/PAP 50	-	6	420	22,080
9909-3710-62	161062	PN 600	600 mm - PAP 75/PAP 100	-	1	-	36,220



SEISMIC

## RA 400

Angolare di rinforzo pesante  
in scatola



Cod. europeo	Cod. fabbrica	Tipo	Descrizione	Conf. (pz)	Imballo (pz)	Pallet (pz)	€/pz
9909-3710-58	161058	RA 400	400 mm - PF3/PF3L/ PF4/PF6/PF3D	-	5	350	37,730



gia

## TRI S

Supporto a squadra pesante  
in scatola



Cod. europeo	Cod. fabbrica	Tipo	Descrizione	Conf. (pz)	Imballo (pz)	Pallet (pz)	€/pz
9909-3613-50	161350	TRI S	200x200 - PF3/PF3L/ PF4/PF6/PF3D	-	5	280	33,680

## JBR 10

Bullone rapido di connessione  
in buste trasparenti



Cod. europeo	Cod. fabbrica	Tipo	Descrizione	Conf. (pz)	Imballo (pz)	Pallet (pz)	€/pz
9909-3519-50	161950	JBR 10	PF3/PF3L/PF4/PF6/PF3D	5	50	6000	4,210

## JDA

Dado a rombo rapido a farfalla  
in buste trasparenti



Cod. europeo	Cod. fabbrica	Tipo	Descrizione	Conf. (pz)	Imballo (pz)	Pallet (pz)	€/pz
9909-3519-60	161960	JDA 6	M6 - PF3/PF3L/PF4/ PF6/PF3D	5	50	6000	1,490
9909-3519-62	161962	JDA 8	M8 - PF3/PF3L/PF4/ PF6/PF3D	5	50	6000	1,520
9909-3519-65	161965	JDA 10	M10 - PF3/PF3L/PF4/ PF6/PF3D	5	50	6000	1,550
9909-3519-68	161968	JDA 12	M12 - PF3/PF3L/PF4/ PF6/PF3D	5	50	6000	1,960

## JDRP

Piastra con dado a rombo rapido  
in buste trasparenti

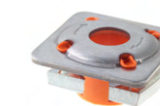

Cod. europeo	Cod. fabbrica	Tipo	Descrizione	Conf. (pz)	Imballo (pz)	Pallet (pz)	€/pz
9909-3519-70	161970	JDRP 6	M6 - PF3/PF3L/PF4/ PF6/PF3D	5	50	6000	3,940
9909-3519-72	161972	JDRP 8	M8 - PF3/PF3L/PF4/ PF6/PF3D	5	50	6000	4,100
9909-3519-75	161975	JDRP 10	M10 - PF3/PF3L/PF4/ PF6/PF3D	5	50	6000	4,100
9909-3519-78	161978	JDRP 12	M12 - PF3/PF3L/PF4/ PF6/PF3D	5	50	6000	4,010



gia

## JDMP

Piastra ad innesto rapido per fissaggio collari in scatola



Cod. europeo	Cod. fabbrica	Tipo	Descrizione	Conf. (pz)	Imballo (pz)	Pallet (pz)	€/pz
9909-3519-80	161980	JDMP 8X70	M8x70mm - PF3/PF3L/PF4/PF6/PF3D	-	10	3360	4,750
9909-3519-85	161985	JDMP 10X70	M10x70mm - PF3/PF3L/PF4/PF6/PF3D	-	10	3360	4,750

## ROS

Rondella sagomata pesante antirotazione in buste trasparenti

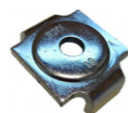

Cod. europeo	Cod. fabbrica	Tipo	Descrizione	Conf. (pz)	Imballo (pz)	Pallet (pz)	€/pz
9909-3519-90	161990	ROS 8	50x8,5x4	5	50	9000	2,490
9909-3519-91	161991	ROS 10	50x10,5x4	5	50	9000	2,590
9909-3519-92	161992	ROS 12	50x12,5x4	5	50	9000	2,690

## DMPR

Dado a rombo con tronchetto e ranella per profili pesanti in scatola



Cod. europeo	Cod. fabbrica	Tipo	Descrizione	Conf. (pz)	Imballo (pz)	Pallet (pz)	€/pz
9909-4023-40	162340	DMPR 8x30	M8x30 mm	10	100	5600	4,480
9909-4023-42	162342	DMPR 8x60	M8x60 mm	10	100	5600	5,200
9909-4023-50	162350	DMPR 10x30	M10x30 mm	10	100	5600	4,950
9909-4023-52	162352	DMPR 10x60	M10x60 mm	10	100	5600	5,630

## DMP

Bullone testa a martello per profili pesanti in buste trasparenti



Cod. europeo	Cod. fabbrica	Tipo	Descrizione	Conf. (pz)	Imballo (pz)	Pallet (pz)	€/pz
9909-4023-30	162330	DMP 8	M8 - PF3/PF3L/PF4/PF6/PF3D	10	50	9000	6,670
9909-4023-31	162331	DMP 10	M10 - PF3/PF3L/PF4/PF6/PF3D	10	50	9000	6,670
9909-4023-32	162332	DMP 12	M12 - PF3/PF3L/PF4/PF6/PF3D	10	50	9000	8,540

## DRP

Dado a rombo per profili pesanti in scatola



Cod. europeo	Cod. fabbrica	Tipo	Descrizione	Conf. (pz)	Imballo (pz)	Pallet (pz)	€/pz
9909-3920-60	162060	DRP 06	M6 - PF3/PF3L/PF4/PF6/PF3D	-	25	75.000	1,380
9909-3921-20	162120	DRP 08	M8 - PF3/PF3L/PF4/PF6/PF3D	-	25	75.000	1,410
9909-3922-20	162220	DRP 10	M10 - PF3/PF3L/PF4/PF6/PF3D	-	25	75.000	1,480
9909-3923-20	162320	DRP 12	M12 - PF3/PF3L/PF4/PF6/PF3D	-	25	75.000	3,110

## BU 12

Bullone in scatola



Cod. europeo	Cod. fabbrica	Tipo	Descrizione	Conf. (pz)	Imballo (pz)	Pallet (pz)	€/pz
9909-4445-20	164520	BU 12	M12x25	-	50	150.000	0,940

## ROP

Rondella pesante piana larga  
in buste trasparenti



Cod. europeo	Cod. fabbrica	Tipo	Descrizione	Conf. (pz)	Imballo (pz)	Pallet (pz)	€/pz
9909-4441-01	164101	ROP 8	40x8x3 x PF3	10	100	18.000	0,620
9909-4442-01	164201	ROP 10	40x10x3 x PF3	10	100	18.000	0,680

## RO

Rondella piana larga  
in buste trasparenti



Cod. europeo	Cod. fabbrica	Tipo	Descrizione	Conf. (pz)	Imballo (pz)	Pallet (pz)	€/pz
9909-0842-70	164270	RO 14	28x15x2,5	8	160	19.200	0,230
9909-0842-71	164271	RO 16	30x17x3	8	160	19.200	0,310
9909-0842-72	164272	RO 18	34x19x3	8	160	19.200	0,390
9909-0842-73	164273	RO 20	37x21x3	8	160	19.200	0,410

## ANS

Angolare connessione rapida a due e a quattro fori  
in scatola

ANS 90



ANS4 90



Cod. europeo	Cod. fabbrica	Tipo	Descrizione	Conf. (pz)	Imballo (pz)	Pallet (pz)	€/pz
9909-3710-30	161030	ANS 90	90° 2 fori - PF3/PF3L/PF4/PF6/PF3D	-	10	3360	3,790
9909-3710-33	161033	ANS4 90	90° 4 fori - PF3/PF3L/PF4/PF6/PF3D	-	10	1800	7,200

## ANS 135

Angolare connessione rapida a tre fori  
in scatola



Cod. europeo	Cod. fabbrica	Tipo	Descrizione	Conf. (pz)	Imballo (pz)	Pallet (pz)	€/pz
9909-3710-52	161052	ANS 135	135° PF3/PF3L/PF4/PF6/PF3D	-	10	1800	3,270

## ANS 45

Angolare connessione rapida bordato  
in scatola



Cod. europeo	Cod. fabbrica	Tipo	Descrizione	Conf. (pz)	Imballo (pz)	Pallet (pz)	€/pz
9909-3710-56	161056	ANS 45	45° PF3/PF3L/PF4/PF6/PF3D	-	10	1200	7,860

## ANS 90 2D

Angolare connessione rapida 2D  
in scatola



Cod. europeo	Cod. fabbrica	Tipo	Descrizione	Conf. (pz)	Imballo (pz)	Pallet (pz)	€/pz
9909-3710-35	161035	ANS 90 2D	2 vie PF3/PF3L/PF4/PF6/PF3D	-	10	1800	12,260

## ANS 90 3D

Angolare connessione rapida 3D  
in scatola

ANS 90 3D DX



Cod. europeo	Cod. fabbrica	Tipo	Descrizione	Conf. (pz)	Imballo (pz)	Pallet (pz)	€/pz
9909-3710-40	161040	ANS 90 3D Sx	3 vie Sx - PF3/PF3L	-	5	280	28,410
9909-3710-44	161044	ANS 90 3D Dx	3 vie Dx - PF3/PF3L	-	5	280	28,410

## ANS 90 4D

Angolare connessione rapida 4D  
in scatola



Cod. europeo	Cod. fabbrica	Tipo	Descrizione	Conf. (pz)	Imballo (pz)	Pallet (pz)	€/pz
9909-3710-48	161048	ANS 90 4D	4 vie - PF3/PF3L	-	5	135	38,060

## ANS T

Angolare connessione rapida a "T" in scatola



Cod. europeo	Cod. fabbrica	Tipo	Descrizione	Conf. (pz)	Imballo (pz)	Pallet (pz)	€/pz
9909-3710-50	161050	ANS T	Raccordo a T - PF3/PF3L	-	5	280	35,280

## CON S

Piastra di congiunzione connessione rapida in scatola

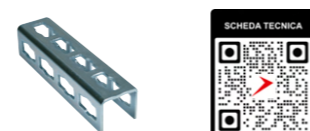

Cod. europeo	Cod. fabbrica	Tipo	Descrizione	Conf. (pz)	Imballo (pz)	Pallet (pz)	€/pz
9909-3614-50	161450	CON S	193 - PF3/PF3L	-	10	1200	11,400

## PON S

Piastra a ponte connessione rapida in scatola



Cod. europeo	Cod. fabbrica	Tipo	Descrizione	Conf. (pz)	Imballo (pz)	Pallet (pz)	€/pz
9909-3615-50	161550	PON S	162 - PF3/PF3L	-	10	1200	7,410

## R

Piastra piana per profili pesanti in scatola



Cod. europeo	Cod. fabbrica	Tipo	Descrizione	Conf. (pz)	Imballo (pz)	Pallet (pz)	€/pz
9909-4214-00	161400	R 1	40x6 1 foro Ø14- PF3/PF4/PF3L	-	10	30.000	2,180
9909-4214-10	161410	R 2	40x6 2 fori Ø14- PF3/PF4/PF3L	-	10	30.000	3,440
9909-4214-20	161420	R 3	40x6 3 fori Ø14- PF3/PF4/PF3L	-	10	3.360	5,290
9909-4214-30	161430	R 4	40x6 4 fori Ø14- PF3/PF4/PF3L	-	10	1.800	7,370

## R 10/15

Piastra sagomata per profili pesanti in scatola



Cod. europeo	Cod. fabbrica	Tipo	Descrizione	Conf. (pz)	Imballo (pz)	Pallet (pz)	€/pz
9909-4214-90	161490	R 10	40x6 3 fori Ø14- PF3/PF4/PF3L	-	5	1680	8,000
9909-4215-40	161540	R 15	40x6 4 fori Ø14- PF3/PF4/PF3L	-	5	1680	10,240

## RA

Piastra angolare per profili pesanti in scatola



Cod. europeo	Cod. fabbrica	Tipo	Descrizione	Conf. (pz)	Imballo (pz)	Pallet (pz)	€/pz
9909-4216-00	161600	RA 2	40x6 foro Ø14- PF3/PF3L	-	5	1680	11,400
9909-4216-10	161610	RA 3S	40x6 sx foro Ø14- PF3/PF3L	-	5	1680	11,400
9909-4216-11	161611	RA 3D	40x6 dx foro Ø14- PF3/PF3L	-	5	1680	11,400

## ANG2 90

Angolare a due fori per profili pesanti in scatola



Cod. europeo	Cod. fabbrica	Tipo	Descrizione	Conf. (pz)	Imballo (pz)	Pallet (pz)	€/pz
9909-4210-20	161020	ANG2 90	40x6 Foro Ø14- PF3/PF4/PF3L	-	10	30.000	4,180

## ANG3

Angolare a tre fori per profili pesanti in scatola



Cod. europeo	Cod. fabbrica	Tipo	Descrizione	Conf. (pz)	Imballo (pz)	Pallet (pz)	€/pz
9909-4210-21	161021	ANG3 90	40x6 - Fori Ø14 PF3/PF4/PF3L/PF6/PF3D	-	10	3360	5,750
9909-4211-21	161121	ANG3 45	40x6 - Fori Ø14 PF3/PF4/PF3L/PF6/PF3D	-	10	3360	5,630

# ANG R

Angolare di rinforzo  
in scatola



Cod. europeo	Cod. fabbrica	Tipo	Descrizione	Conf. (pz)	Imballo (pz)	Pallet (pz)	€/pz
9909-4211-90	161190	ANG R	36x4 - Foro Ø14,5 PF3/PF4/PF3L/PF6/PF3D	-	10	3360	4,350



## PROFILI G-STRUT

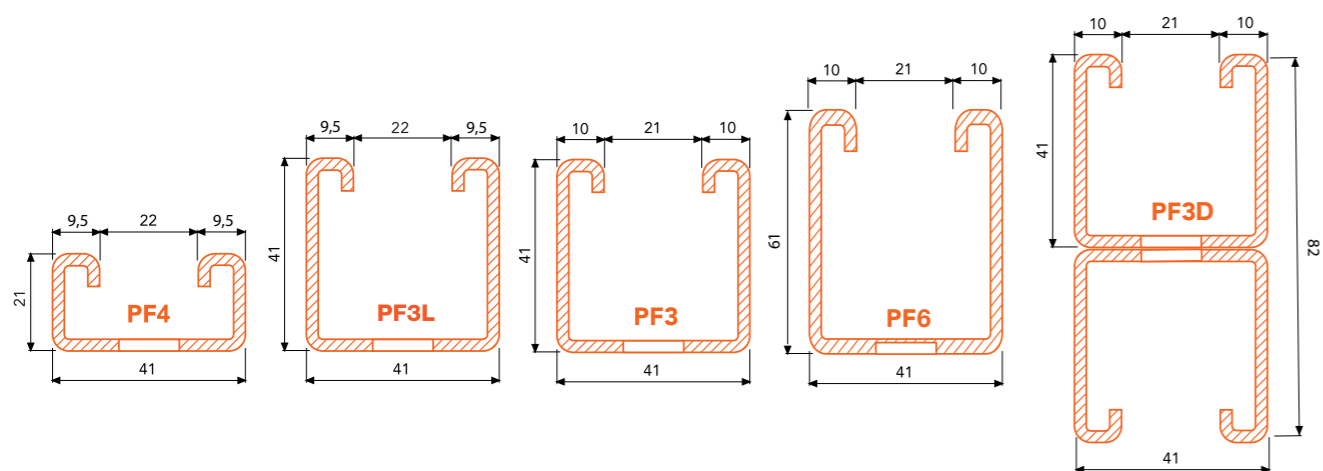

PROFILATO	SPESSORE mm.	PESO Kg./m.	AREA RESISTENTE mm <sup>2</sup>	Valori statici riferiti agli assi neutri				Geometrici		
				Jx cm <sup>4</sup>	Jy cm <sup>4</sup>	Wx cm <sup>3</sup>	Wy cm <sup>3</sup>	A	B	C
PF4	2	1,48	165,20	0,91	4,31	0,82	2,10	30	13	50
PF3	2,5	2,56	308,01	6,96	9,62	3,36	4,68	30	13	50
PF3L	2	2,06	245,10	5,33	7,71	2,58	3,70	30	13	50
PF6	2,5	3,46	424,00	18,57	13,19	5,95	6,43	30	13	50
PF3D	2,5	5,12	616,02	41,49	18,98	10,12	9,25	30	13	50

## CARICHI AMMISSIBILI

Materiale: acciaio al carbonio DX 51 D  
Asse prove x -x  
Perfetto ritorno elastico  
Carico di sicurezza 140 N/mm<sup>2</sup> (14 Kg./mm<sup>2</sup>)

F = carico concentrato in daN  
Q = carico uniformemente distribuito in daN/m  
La freccia non supera L/250

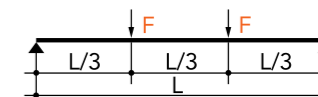
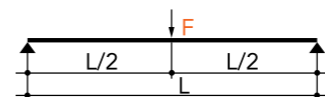

L= mm	500	1000	1500	2000	2500	3000
PF4	100	40	18	10	6	4
PF3	370	180	120	65	40	30
PF3L	295	145	95	52	30	16
PF6	450	227	160	109	70	48
PF3D	585	292	195	146	117	84

L= mm	500	1000	1500	2000	2500	3000
PF4	80	23	10	5	3	-
PF3	280	140	70	40	25	15
PF3L	220	110	50	28	16	11
PF6	300	200	110	70	40	20
PF3D	400	250	230	110	60	25

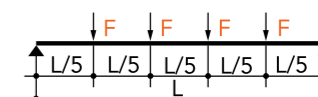
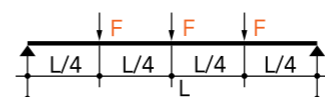

L= mm	500	1000	1500	2000	2500	3000
PF4	53	16	7	4	2	-
PF3	150	80	50	25	15	10
PF3L	100	50	35	17	10	6
PF6	180	90	55	37	24	16
PF3D	240	130	67	45	31	21

L= mm	500	1000	1500	2000	2500	3000
PF4	45	13	5	3	-	-
PF3	110	70	40	20	13	9
PF3L	90	45	30	15	8	5
PF6	160	120	51	33	23	14
PF3D	210	190	66	42	30	20

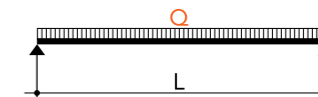
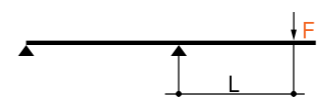

L= mm	500	1000	1500	2000	2500	3000
PF4	52	15	10	5	3	-
PF3	110	55	30	20	13	5
PF3L	75	25	15	7	5	3
PF6	135	62	35	25	19	7
PF3D	200	90	50	35	25	10

L= mm	500	1000	1500	2000	2500	3000
PF4	200	65	20	8	4	-
PF3	700	335	131	55	28	15
PF3L	500	180	100	42	20	11
PF6	900	450	220	110	90	45
PF3D	1200	700	370	270	120	80

# SISTEMA ANTISISMICO SEISMIC-STRUT

## AGG SM

Aggancio antisismico universale a muro per rinforzo laterale e longitudinale in scatola



Cod. europeo	Cod. fabbrica	Tipo	Descrizione	Conf. (pz)	Imballo (pz)	Pallet (pz)	€/pz
9909-4517-51	161751	AGG SM	Per tubi zincati 1" serie pesante	-	1	-	47,090

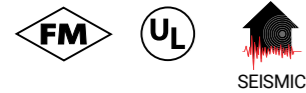

## AST

Aggancio antisismico per travi in acciaio in scatola



Cod. europeo	Cod. fabbrica	Tipo	Descrizione	Conf. (pz)	Imballo (pz)	Pallet (pz)	€/pz
9909-4517-52	161752	AST	Per travi in acciaio	-	1	-	42,810

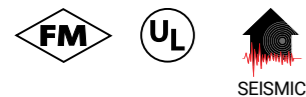

## CSPR

Collare antisismico di rinforzo laterale e longitudinale in scatola



Cod. europeo	Cod. fabbrica	Tipo	Descrizione	Conf. (pz)	Imballo (pz)	Pallet (pz)	€/pz
9908-3743-01	084301	CSPR 1"	Tubo DN 25	-	1	-	40,410
9908-3744-01	084401	CSPR 1 1/4"	Tubo DN 32	-	1	-	41,220
9908-3745-01	084501	CSPR 1 1/2"	Tubo DN 40	-	1	-	43,340
9908-3746-01	084601	CSPR 2"	Tubo DN 50	-	1	-	45,190
9908-3747-01	084701	CSPR 2 1/2"	Tubo DN 65	-	1	-	47,580
9908-3748-01	084801	CSPR 3"	Tubo DN 80	-	1	-	49,180
9908-3749-01	084901	CSPR 4"	Tubo DN 100	-	1	-	61,950
9908-3749-31	084931	CSPR 5"	Tubo DN 125	-	1	-	79,990
9908-3749-51	084951	CSPR 6"	Tubo DN 150	-	1	-	96,740
9908-3749-71	084971	CSPR 8"	Tubo DN 200	-	1	-	127,200

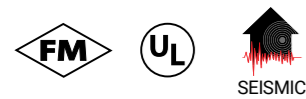

## ANG R SNO

Angolare universale a snodo per barra filettata in scatola



Cod. europeo	Cod. fabbrica	Tipo	Descrizione	Conf. (pz)	Imballo (pz)	Pallet (pz)	€/pz
9909-4517-53	161753	ANG R SNO	Per BF10	-	1	-	24,020

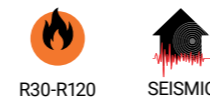

## CER SM

Cerniera antisismica G-STRUT in scatola



Cod. europeo	Cod. fabbrica	Tipo	Descrizione	Conf. (pz)	Imballo (pz)	Pallet (pz)	€/pz
9909-4517-54	161754	CER SM	Per profili G-Strut PF3/PF3L	-	1	-	24,160



## ANG SM 90°

Angolare antisismico a 90° G-STRUT in scatola

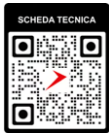

Cod. europeo	Cod. fabbrica	Tipo	Descrizione	Conf. (pz)	Imballo (pz)	Pallet (pz)	€/pz
9909-4517-55	161755	ANG SM 90°	Per profili G-STRUT PF3/PF3L/PF4/PF6/PF3D	-	1	-	20,810



## CON SM

Connessione antisismica a cerniera universale in scatola



Cod. europeo	Cod. fabbrica	Tipo	Descrizione	Conf. (pz)	Imballo (pz)	Pallet (pz)	€/pz
9909-4517-56	161756	CON SM	Per profili G-STRUT PF3/PF3L/PF4/PF6/PF3D	-	1	-	37,450



SEISMIC

## RIN STO 1

Rinforzo antisismico a snodo per collare con BF10 in scatola



Cod. europeo	Cod. fabbrica	Tipo	Descrizione	Conf. (pz)	Imballo (pz)	Pallet (pz)	€/pz
9909-4517-57	161757	RIN STO1	Per BF10	-	1	-	24,700



SEISMIC

## BUR BF

Bullone di rinforzo con profilo G-STRUT per barre filettate in scatola



Cod. europeo	Cod. fabbrica	Tipo	Descrizione	Conf. (pz)	Imballo (pz)	Pallet (pz)	€/pz
9909-4522-22	162222	BUR BF	Per BF M10/M12	-	25	75.000	8,440



SEISMIC

## PN 300/600

Puntone di rinforzo G-STRUT in scatola



Cod. europeo	Cod. fabbrica	Tipo	Descrizione	Conf. (pz)	Imballo (pz)	Pallet (pz)	€/pz
9909-3710-60	161060	PN 300	300 mm - PAP 40/PAP 50	-	6	420	22,080
9909-3710-62	161062	PN 600	600 mm - PAP 75/PAP 100	-	1	-	36,220



SEISMIC



gia

## ANG R

Angolare di rinforzo in scatola



Cod. europeo	Cod. fabbrica	Tipo	Descrizione	Conf. (pz)	Imballo (pz)	Pallet (pz)	€/pz
9909-4211-90	161190	ANG R	36x4 - Foro Ø14,5 PF3/PF3L/PF4/PF6/PF3D	-	10	3360	4,350



SEISMIC

## SSU

Sospensione snodata universale in scatola



Cod. europeo	Cod. fabbrica	Tipo	Descrizione	Conf. (pz)	Imballo (pz)	Pallet (pz)	€/pz
9909-5017-50	161750	SSU	Asola 10,5 x 12	-	10	1200	18,880



SEISMIC

## VCLS

Vite antisismica per calcestruzzo con attacco femmina in buste trasparenti



Cod. europeo	Cod. fabbrica	Tipo	Descrizione	Conf. (pz)	Imballo (pz)	Pallet (pz)	€/pz
9904-0110-00	130000	VCLS M6	Foro Ø6	5	25	8400	1,500
9904-0110-01	130001	VCLS M8	Foro Ø6	5	25	8400	1,580
9904-0110-02	130002	VCLS M10	Foro Ø6	5	25	8400	1,580
9904-0110-05	130005	VCLS M8/M10	Foro Ø6	5	25	8400	1,730



ETA 17/0806



R30-R120



SEISMIC



gia

## VTE CLS SM

Vite antisismica ad alte prestazioni per calcestruzzo in scatola



Cod. europeo	Cod. fabbrica	Tipo	Descrizione	Conf. (pz)	Imballo (pz)	Pallet (pz)	€/pz
9904-0110-51	130051	VTE CLS 8x60 SM	8x60 - Foro Ø8	-	25	8400	1,530
9904-0110-53	130053	VTE CLS 10x60 SM	10x60 - Foro Ø10	-	25	8400	2,100
9904-0110-55	130055	VTE CLS 10x85 SM	10x85 - Foro Ø10	-	25	8400	2,350
9904-0110-57	130057	VTE CLS 10x100 SM	10x100 - Foro Ø10	-	25	8400	2,560



ETA 17/0806



R30-R120



SEISMIC

## TLA SM

Ancorante antisismico C1-C2 in scatola



Cod. europeo	Cod. fabbrica	Tipo	Descrizione	Conf. (pz)	Imballo (pz)	Pallet (pz)	€/pz
9904-0201-62	130162	TLA SM 8X80	M8 - Foro Ø8	-	100	33.600	1,800
9904-0201-64	130164	TLA SM 8X95	M8 - Foro Ø8	-	100	33.600	2,130
9904-0201-72	130172	TLA SM 10X90	M10 - Foro Ø10	-	50	16.800	2,540
9904-0201-74	130174	TLA SM 10X110	M10 - Foro Ø10	-	50	16.800	3,100
9904-0201-82	130182	TLA SM 12X105	M12 - Foro Ø12	-	25	8.400	3,570
9904-0201-84	130184	TLA SM 12X125	M12 - Foro Ø12	-	25	8.400	4,440



EAD 330232-00-0601



R30-R120



SEISMIC

## VSF

Ancorante chimico professionale antisismico senza stirene in scatola



Cod. europeo	Cod. fabbrica	Tipo	Descrizione	Conf. (pz)	Imballo (pz)	Pallet (pz)	€/pz
2500-0039-36	01320	VSF + 300	300ml + 1 mixer	-	12	-	16,220



Tested for LEED compliancy



Styrene Free



EAD 330067-01-0801



EAD 330499-01-0601



EAD 330076-0-0604



SEISMIC



SIMPLIFY  
YOUR  
WORK

# SCORREVOLI E ACCESSORI

## MOR PF3

Morsetto a cavallotto M10 per profili pesanti PF3 in scatola



Cod. europeo	Cod. fabbrica	Tipo	Descrizione	Conf. (pz)	Imballo (pz)	Pallet (pz)	€/pz
9909-4855-20	165520	MOR PF3	M10	-	10	1200	11,760

## MOR

Morsetto di aggancio in scatola



Cod. europeo	Cod. fabbrica	Tipo	Descrizione	Conf. (pz)	Imballo (pz)	Pallet (pz)	€/pz
9909-4855-01	165501	MOR 8	M8	-	25	3000	6,970
9909-4855-02	165502	MOR 10	M10	-	25	3000	8,220
9909-4855-03	165503	MOR 12	M12	-	25	3000	12,690

## MOR 2

Morsetto di aggancio oscillante in scatola



Cod. europeo	Cod. fabbrica	Tipo	Descrizione	Conf. (pz)	Imballo (pz)	Pallet (pz)	€/pz
9909-4855-50	165550	MOR 2	M10	-	5	600	37,130

## SSU

Sospensione snodata universale in scatola



Cod. europeo	Cod. fabbrica	Tipo	Descrizione	Conf. (pz)	Imballo (pz)	Pallet (pz)	€/pz
9909-5017-50	161750	SSU	Asola 10,5 x 12	-	10	1200	18,880



## RDA

Regolatore d'altezza in scatola



Cod. europeo	Cod. fabbrica	Tipo	Descrizione	Conf. (pz)	Imballo (pz)	Pallet (pz)	€/pz
9909-5017-00	161700	RDA	Foro Ø14,5	-	30	3600	4,520

## RDA S

Regolatore d'altezza insonorizzato in scatola



Cod. europeo	Cod. fabbrica	Tipo	Descrizione	Conf. (pz)	Imballo (pz)	Pallet (pz)	€/pz
9909-5017-10	161710	RDA S	M10	-	20	2400	10,830

## TPF

Tappo per profilo in scatola



Cod. europeo	Cod. fabbrica	Tipo	Descrizione	Conf. (pz)	Imballo (pz)	Pallet (pz)	€/pz
9909-5000-50	160050	TPF	PF	-	200	24.000	0,870
9909-5001-50	160150	TPF 1	PF 1	-	200	24.000	0,960
9909-5001-58	160158	TPF 2-7	PF 2 - PF 7	-	200	24.000	0,960
9909-5003-50	160350	TPF 3	PF 3	-	50	6.000	1,400
9909-5004-50	160450	TPF 4	PF 4	-	50	16.800	1,030



## SNO

Attacco a snodo  
in scatola



Cod. europeo	Cod. fabbrica	Tipo	Descrizione	Conf. (pz)	Imballo (pz)	Pallet (pz)	€/pz
9909-5033-20	163320	SNO 8	M8xM8	-	50	9000	6,920
9909-5035-20	163520	SNO 10	M10xM10	-	50	9000	7,950

## SC

Supporto scorrevole  
in scatola



Cod. europeo	Cod. fabbrica	Tipo	Descrizione	Conf. (pz)	Imballo (pz)	Pallet (pz)	€/pz
9909-5050-00	165000	SC		-	20	1120	23,840

## SCB

Slitta scorrevole con base profilo  
in scatola



Cod. europeo	Cod. fabbrica	Tipo	Descrizione	Conf. (pz)	Imballo (pz)	Pallet (pz)	€/pz
9909-5050-05	165005	SCB	Base fori Ø 9	-	10	560	23,840

## SPF

Slitta di scorrimento  
in scatola

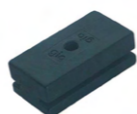

Cod. europeo	Cod. fabbrica	Tipo	Descrizione	Conf. (pz)	Imballo (pz)	Pallet (pz)	€/pz
9909-5050-10	165010	SPF	Per PF/PF INOX	-	50	6000	5,650

## PFG

Guaina isolante per profilo  
in scatola



Cod. europeo	Cod. fabbrica	Tipo	Descrizione	Conf. (pz)	Imballo (pz)	Pallet (pz)	€/pz
9909-5065-00	166500	PFG	10 mt	-	10	270	26,060

## RP

Rullo piano per tubazioni  
in scatola



Cod. europeo	Cod. fabbrica	Tipo	Descrizione	Conf. (pz)	Imballo (pz)	Pallet (pz)	€/pz
9909-4957-20	165720	RP 1	Per tubi Ø 0-160	-	1	-	56,410
9909-4957-21	165721	RP 2	Per tubi Ø 50-160	-	1	-	59,470

## RR

Rullo piano pesante per tubazioni  
in scatola



Cod. europeo	Cod. fabbrica	Tipo	Descrizione	Conf. (pz)	Imballo (pz)	Pallet (pz)	€/pz
9909-4957-30	165730	RR 1	Per tubi Ø 50-150	-	1	-	112,800
9909-4957-31	165731	RR 2	Per tubi Ø 100-300	-	1	-	365,200
9909-4957-32	165732	RR 3	Per tubi Ø 200-500	-	1	-	501,900

## RV

Rullo concavo per tubazioni  
in scatola

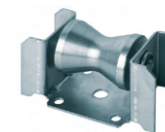

Cod. europeo	Cod. fabbrica	Tipo	Descrizione	Conf. (pz)	Imballo (pz)	Pallet (pz)	€/pz
9909-4957-00	165700	RV 1	Per tubi Ø 50-100	-	1	-	70,280
9909-4957-01	165701	RV 2	Per tubi Ø 100-180	-	1	-	150,700
9909-4957-02	165702	RV 3	Per tubi Ø 150-250	-	1	-	370,400
9909-4957-03	165703	RV 4	Per tubi Ø 200-350	-	1	-	579,900

## RS

Supporto a rullo per selle  
in scatola



Cod. europeo	Cod. fabbrica	Tipo	Descrizione	Conf. (pz)	Imballo (pz)	Pallet (pz)	€/pz
9909-4957-50	165750	RS 1	Per SE 1 - Max 600 kg	-	1	-	53,650
9909-4957-51	165751	RS 2	Per SE 2 - Max 1000 kg	-	1	-	95,370
9909-4957-52	165752	RS 3	Per SE 3 - Max 1500 kg	-	1	-	259,700
9909-4957-53	165753	RS 4	Per SE 4 - Max 2500 kg	-	1	-	515,800

## SE

Sella di appoggio tubi coibentati  
in scatola



Cod. europeo	Cod. fabbrica	Tipo	Descrizione	Conf. (pz)	Imballo (pz)	Pallet (pz)	€/pz
9909-4957-60	165760	SE 1	Per tubi Ø 0-80	-	1	-	41,390
9909-4957-61	165761	SE 2	Per tubi Ø 80-180	-	1	-	48,540
9909-4957-62	165762	SE 3	Per tubi Ø 180-300	-	1	-	82,930
9909-4957-63	165763	SE 4	Per tubi Ø 300-500	-	1	-	145,700

## DATI TECNICI

### DILATAZIONE LINEARE DELLE TUBAZIONI

Per effetto degli sbalzi di temperatura ( $\Delta t^{\circ}\text{C}$ ) le tubazioni subiscono un allungamento lineare. Questo allungamento cambia a secondo del materiale di cui è composta la tubazione.

### INDICAZIONE DEI PRINCIPALI COEFFICIENTI DI DILATAZIONE LINEARE PER LE TUBATURE PIÙ UTILIZZATE

Prodotti	Materiale	mm/mK
TUBI IN PLASTICA	PE	0,2000
	PP	0,1500
	PVDF	0,1200
	PVC	0,0700
	PE-HD	0,0260
TUBI IN ACCIAIO	ACCIAIO INOX	0,0169
	RAME (Cu)	0,0170
	ACCIAIO (Fe)	0,0123

### FORMULA PER IL CALCOLO DELL'ALLUNGAMENTO

$$\Delta L = L_0 * (T_2 - T_1) * \lambda$$

Dove:

- $\Delta L$  è l'allungamento in mm
- $L_0$  è la lunghezza iniziale in m
- $T_2$  è la temperatura finale (vedi nota)
- $T_1$  è la temperatura iniziale (vedi nota)
- $\lambda$  è il coefficiente di dilatazione in mm/mK

Nota: trattandosi di una differenza di temperatura ( $\Delta t=T_2-T_1$ ) non è necessario usare i K (kelvin), ma si possono usare anche i  $^{\circ}\text{C}$  (gradi celsius).

Nei diagrammi sono proposti gli allungamenti ( $\Delta L$ .mm) subiti da varie tubazioni lunghe 1 mt. Con sbalzi termici ( $\Delta t^{\circ}\text{C}$ ) compresi tra  $0^{\circ}\text{C}$  e  $70^{\circ}\text{C}$ .

### DILATAZIONE TUBI IN PLASTICA

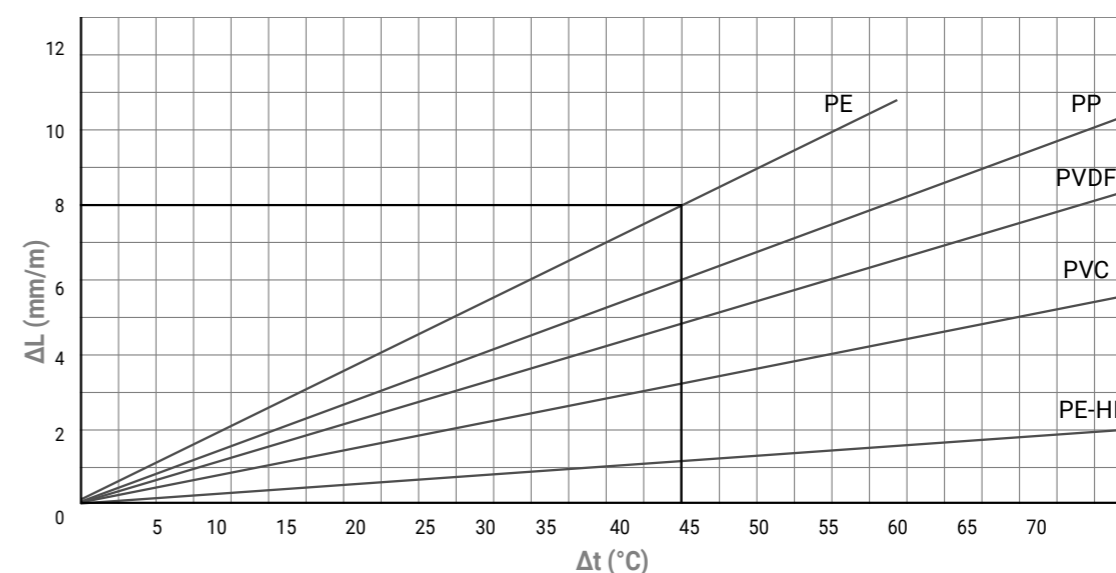

Esempio: Tubazione PE – sbalzo termico  $\Delta t 40^{\circ}\text{C}$  – allungamento 8mm – Per 5 mt di tubazione (8x5) 40 mm.

DILATAZIONE TUBI IN ACCIAIO (FE), ACCIAIO INOX E RAME

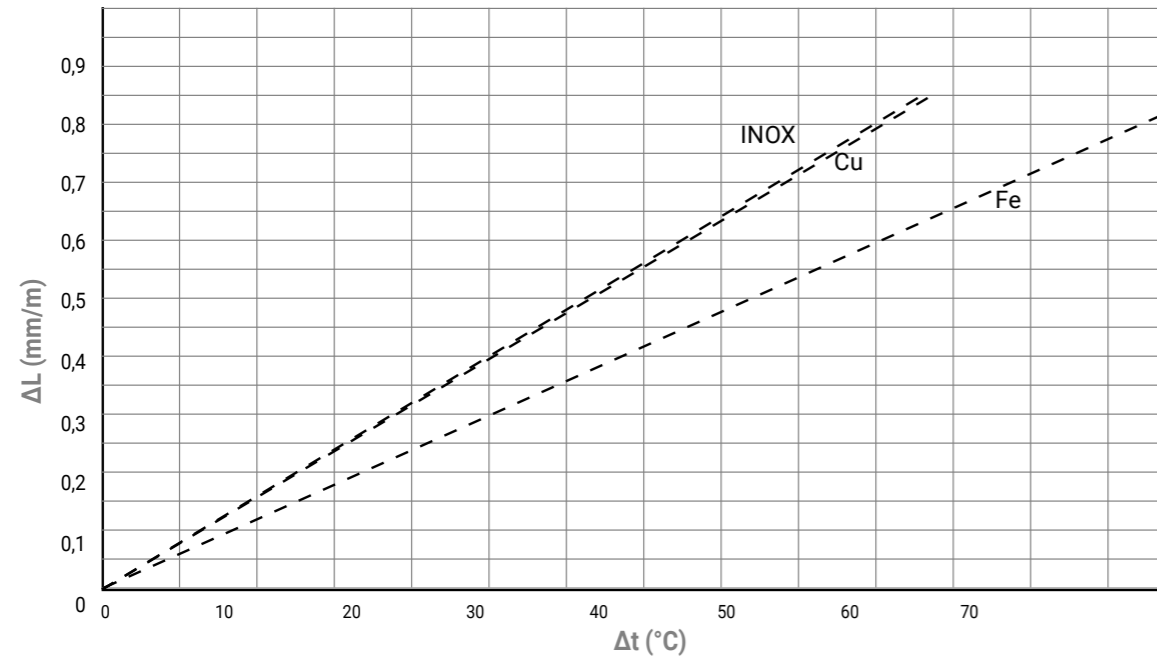

MENSOLE SALDATE

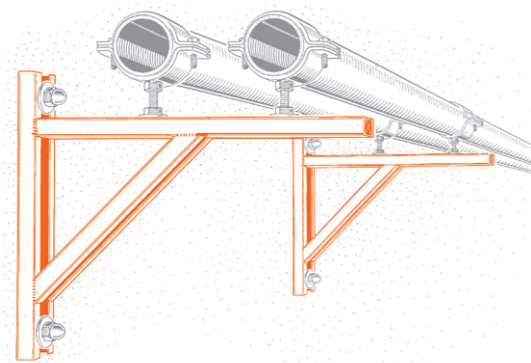

CARICHI AMMISSIBILI

Materiale: acciaio DX 51 D DZ200 EN 10142 zincatura sendzimir - Carico di sicurezza 140 N/mm<sup>2</sup> (14 Kg./mm<sup>2</sup>)

F = carico concentrato in daN

Q = carico uniformemente distribuito in daN

La freccia non supera L/250

Per carico ammissibile si intende la resistenza ultima media a cui è stato applicato un coefficiente di sicurezza.

1daN=1 kg.

Per il fissaggio a muro attenersi alle caratteristiche di tenuta dell'ancorante o del supporto di raccordo.



Tipo	F1 = daN	F1 = daN	F2 = daN	F2 = daN
PA 30 GRIP	75	37	37	75
PA 40 GRIP	110	50	50	110
PAP 30	180	90	90	180
PAP 40	140	80	80	140
PAP 50	185	95	95	185
PAP 75	125	60	60	125
PAP 100	72	30	30	72

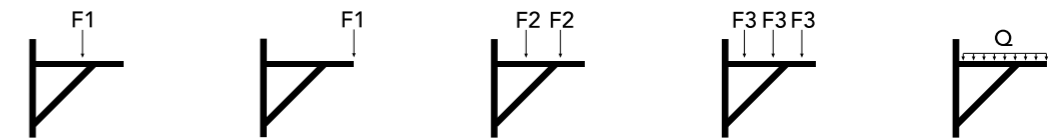

Tipo	F1 = daN	F1 = daN	F2 = daN	F3 = daN	Q= daN
SAT	250	70	125	75	200
SAT 1	200	40	90	55	130
SAT BIANCA	250	70	125	75	200
SAT 1 BIANCA	200	40	90	55	130
SAT 2 GRIP	250	50	125	85	200

# 7. FISSAGGI INOX

La famiglia Inox 304 di GIA comprende collari, piattelli, accessori, profilati e bulloneria, progettati per applicazioni in ambienti chimicamente aggressivi o esposti a condizioni atmosferiche impegnative, garantendo resistenza alla corrosione, sicurezza e durata.

SCOPRI DI PIÙ,  
INQUADRA IL  
QR CODE



## STO 1 INOX

Collare pesante INOX  
in buste trasparenti



Cod. europeo	Cod. fabbrica	Tipo	Descrizione	Conf. (pz)	Imballo (pz)	Pallet (pz)	€/pz
9908-2220-10	082010	STO1 INOX 3/8"	M8	2	50	1350	8,900
9908-2221-10	082110	STO1 INOX 1/2"	M8	2	50	1350	8,900
9908-2222-10	082210	STO1 INOX 3/4"	M8	2	50	1350	9,660
9908-2223-10	082310	STO1 INOX 1"	M8	2	50	1350	11,200
9908-2224-10	082410	STO1 INOX 1 1/4"	M8	2	50	1350	12,420
9908-2225-10	082510	STO1 INOX 1 1/2"	M8	2	50	1350	13,400
9908-2225-60	082560	STO1 INOX 54	M8	2	50	1350	14,810
9908-2226-10	082610	STO1 INOX 2"	M8	2	50	1350	16,230
9908-2227-10	082710	STO1 INOX 2 1/2"	M10	2	35	945	25,120
9908-2228-10	082810	STO1 INOX 3"	M10	2	30	810	25,630
9908-2228-60	082860	STO1 INOX 3 1/2"	M10	2	25	675	31,170
9908-2229-10	082910	STO1 INOX 4"	M10	2	20	540	33,360
9908-2229-32	082932	STO1 INOX M10 5"	M10	1	10	560	35,430
9908-2229-52	082952	STO1 INOX M10 6"	M10	1	10	560	37,360
9908-2229-31	082931	STO1 INOX 5"	1/2"	1	10	270	75,580
9908-2229-51	082951	STO1 INOX 6"	1/2"	1	10	270	89,150

## CX

Collarino INOX  
in scatola



Cod. europeo	Cod. fabbrica	Tipo	Descrizione	Conf. (pz)	Imballo (pz)	Pallet (pz)	€/pz
9908-2140-12	084012	CX 12	M6 - Giolli Ø6	5	100	12.000	3,360
9908-2140-15	084015	CX 15	M6 - Giolli Ø6	5	100	12.000	3,490
9908-2140-18	084018	CX 18	M6 - Giolli Ø6	5	100	12.000	3,540
9908-2140-22	084022	CX 22	M6 - Giolli Ø6	5	100	12.000	3,620
9908-2140-28	084028	CX 28	M6 - Giolli Ø6	5	100	12.000	3,730

## CAV INOX

Cavallotto INOX a "U"  
in scatola



Cod. europeo	Cod. fabbrica	Tipo	Descrizione	Conf. (pz)	Imballo (pz)	Pallet (pz)	€/pz
9908-2970-10	167010	CAV INOX 3/8"	Ø 6	-	100	12.000	3,960
9908-2972-10	167210	CAV INOX 1/2"	Ø 6	-	100	12.000	4,280
9908-2974-10	167410	CAV INOX 3/4"	Ø 6	-	100	12.000	4,430
9908-2976-10	167610	CAV INOX 1"	Ø 6	-	100	12.000	4,670
9908-2978-10	167810	CAV INOX 1 1/4"	Ø 6	-	100	12.000	5,020
9908-2980-10	168010	CAV INOX 1 1/2"	Ø 8	-	80	9.600	8,500
9908-2982-10	168210	CAV INOX 2"	Ø 8	-	50	6.000	9,250
9908-2984-10	168410	CAV INOX 2 1/2"	Ø 8	-	50	6.000	10,390
9908-2986-10	168610	CAV INOX 3"	Ø 8	-	30	3.600	11,320
9908-2988-10	168810	CAV INOX 3 1/2"	Ø 8	-	30	3.600	12,500
9908-2990-10	169010	CAV INOX 4"	Ø 8	-	30	3.600	13,460

## STO1G INOX

Collare pesante INOX con gomma EPDM  
in scatola



Cod. europeo	Cod. fabbrica	Tipo	Descrizione	Conf. (pz)	Imballo (pz)	Pallet (pz)	€/pz
9908-2320-19	082019	STO1G INOX 3/8"	M8	-	50	6.000	5,970
9908-2321-19	082119	STO1G INOX 1/2"	M8	-	50	6.000	5,970
9908-2322-19	082219	STO1G INOX 3/4"	M8	-	50	2.800	6,090
9908-2323-19	082319	STO1G INOX 1"	M8	-	50	2.800	6,930
9908-2324-19	082419	STO1G INOX 1 1/4"	M8	-	50	2.800	7,350
9908-2325-19	082519	STO1G INOX 1 1/2"	M8	-	30	1.680	7,990
9908-2325-69	082569	STO1G INOX 54	M8	-	25	1.400	8,930
9908-2326-19	082619	STO1G INOX 2"	M10	-	20	1.120	15,580
9908-2327-19	082719	STO1G INOX 2 1/2"	M10	-	10	560	16,230
9908-2328-19	082819	STO1G INOX 3"	M10	-	10	560	18,810
9908-2328-69	082869	STO1G INOX 3 1/2"	M10	-	10	560	19,960
9908-2329-19	082919	STO1G INOX 4"	M10	-	10	560	21,770

## CTF INOX

Collare INOX a clip per tubi fumo  
in scatola



Cod. europeo	Cod. fabbrica	Tipo	Descrizione	Conf. (pz)	Imballo (pz)	Pallet (pz)	€/pz
9908-5330-05	073005	CTF 60 INOX	Giolli Ø10	1	20	1120	16,860
9908-5330-15	073015	CTF 70 INOX	Giolli Ø10	1	35	945	18,940
9908-5330-25	073025	CTF 80 INOX	Giolli Ø10	1	35	945	19,070
9908-5330-35	073035	CTF 100 INOX	Giolli Ø10	1	35	945	19,960
9908-5330-45	073045	CTF 110 INOX	Giolli Ø10	1	35	945	20,350
9908-5330-55	073055	CTF 120 INOX	Giolli Ø10	1	35	945	20,870
9908-5330-65	073065	CTF 130 INOX	Giolli Ø10	1	30	810	21,130
9908-5330-75	073075	CTF 140 INOX	Giolli Ø10	1	25	675	21,650
9908-5330-85	073085	CTF 150 INOX	Giolli Ø10	1	25	675	22,150

## CTF INOX

Collare INOX per tubi fumo  
in scatola



Cod. europeo	Cod. fabbrica	Tipo	Descrizione	Conf. (pz)	Imballo (pz)	Pallet (pz)	€/pz
9908-5330-95	073095	CTF 160 INOX	M10 - Giolli Ø12	1	10	560	53,040
9908-5331-05	073105	CTF 180 INOX	M10 - Giolli Ø12	1	10	560	57,430
9908-5331-15	073115	CTF 200 INOX	M10 - Giolli Ø12	1	5	280	66,500

## PP1 INOX

Piattello INOX  
in buste trasparenti



Cod. europeo	Cod. fabbrica	Tipo	Descrizione	Conf. (pz)	Imballo (pz)	Pallet (pz)	€/pz
9908-2295-11	089511	PP1 INOX	40x100x3 - Giolli Ø10 Attacco 1/2" GAS	1	10	1200	39,160

## TF INOX

Fissaggio INOX per collari  
in scatola



Cod. europeo	Cod. fabbrica	Tipo	Descrizione	Conf. (pz)	Imballo (pz)	Pallet (pz)	€/pz
9904-1664-05	146405	10TF INOX	8x90	2	100	2.700	5,920
9904-1665-05	146505	12TF INOX	10x100	2	60	3.360	9,920

## VLM INOX

Vitone INOX doppio filetto  
in scatola



Cod. europeo	Cod. fabbrica	Tipo	Descrizione	Conf. (pz)	Imballo (pz)	Pallet (pz)	€/pz
9904-1647-06	164706	VLM 8X200 INOX		-	100	12.000	6,710
9904-1647-16	164716	VLM 10X165 INOX		-	50	9.000	8,370

## BF INOX

Barra filettata INOX  
in fasci



Cod. europeo	Cod. fabbrica	Tipo	Descrizione	Conf. (pz)	Imballo (pz)	Pallet (pz)	€/pz
9906-0849-10	264910	BF/6 INOX	M6x1000	1	5	5	8,820
9906-0850-10	265010	BF/8 INOX	M8x1000	1	5	5	12,550
9906-0851-10	265110	BF/10 INOX	M10x1000	1	5	5	18,010
9906-0852-10	265210	BF/12 INOX	M12x1000	1	5	5	25,210

## AN INOX

Manicotto INOX di connessione per barre filettate  
in buste trasparenti



Cod. europeo	Cod. fabbrica	Tipo	Descrizione	Conf. (pz)	Imballo (pz)	Pallet (pz)	€/pz
9909-2732-11	163211	AN 6 INOX	M6x25	5	50	16.800	8,170
9909-2733-11	163311	AN 8 INOX	M8x25	5	50	16.800	8,790
9909-2735-11	163511	AN 10 INOX	M10x30	5	50	16.800	9,710
9909-2736-11	163611	AN 12 INOX	M12x35	5	50	16.800	13,220

## CAT INOX

Catena genovese INOX  
in scatola



Cod. europeo	Cod. fabbrica	Tipo	Descrizione	Conf. (pz)	Imballo (pz)	Pallet (pz)	€/pz
9906-2003-01	270301	CAT 3 INOX	20 mt	20	40	2.240	26,140

## GA 5 INOX

Gancio INOX a "S" per catena  
in buste trasparenti



Cod. europeo	Cod. fabbrica	Tipo	Conf. (pz)	Imballo (pz)	Pallet (pz)	€/pz
9906-2010-51	271051	GA 5 INOX	2	100	12.000	3,630

## GRI 6 INOX

Grillo INOX per catena  
in scatola



Cod. europeo	Cod. fabbrica	Tipo	Conf. (pz)	Imballo (pz)	Pallet (pz)	€/pz
9906-2020-01	272001	GRI 6 INOX	-	50	16.800	14,980

## PF INOX

Profilo INOX  
in fasci



Cod. europeo	Cod. fabbrica	Tipo	Descrizione	Conf. (pz)	Imballo (pz)	Pallet (pz)	€/pz
9909-2500-10	160010	PF INOX	30x15x1,5 - 2 mt	100	10	10	85,520
9909-2501-10	160110	PF1 INOX	32x20x2,5 - 2 mt	48	8	8	119,900

## PF3S INOX

Profilo pesante INOX  
in fasci



Cod. europeo	Cod. fabbrica	Tipo	Descrizione	Conf. (pz)	Imballo (pz)	Pallet (pz)	€/pz
9909-2502-09	700209	PF3S INOX MT 1,5	41x41x2,0 - 1,5 mt	4	4	4	115,100
9909-2502-10	700210	PF3S INOX MT 3	41x41x2,0 - 3,0 mt	30	4	4	230,000

## PA INOX

Supporto INOX per profili PF e PF1 INOX  
in scatola



Cod. europeo	Cod. fabbrica	Tipo	Descrizione	Conf. (pz)	Imballo (pz)	Pallet (pz)	€/pz
9909-2612-01	161201	PA INOX	PF INOX - PF1 INOX	-	10	1200	31,010

## PA 30 INOX

Mensola INOX in profilo PF1 INOX  
in scatola



Cod. europeo	Cod. fabbrica	Tipo	Descrizione	Conf. (pz)	Imballo (pz)	Pallet (pz)	€/pz
9909-2612-21	161221	PA 30 INOX	285mm - PF1 INOX	-	10	560	59,400

## SAT INOX

Mensola INOX a squadra in profili PF e PF1 INOX  
in scatola



Cod. europeo	Cod. fabbrica	Tipo	Descrizione	Conf. (pz)	Imballo (pz)	Pallet (pz)	€/pz
9909-2612-85	161285	SAT INOX	365 mm - PF INOX	-	10	210	93,740
9909-2612-82	161282	SAT 1 INOX	545 mm - PF 1 INOX	-	10	120	116,400

## DR INOX

Dado a rombo INOX per profili PF e PF1 INOX  
in buste trasparenti



Cod. europeo	Cod. fabbrica	Tipo	Descrizione	Conf. (pz)	Imballo (pz)	Pallet (pz)	€/pz
9909-2721-10	162110	DR 8 INOX	M8	10	200	36.000	3,130
9909-2722-10	162210	DR 10 INOX	M10	10	200	36.000	3,440

## ANG INOX

Angolare INOX per profili leggeri PF e PF1 INOX  
in buste trasparenti



Cod. europeo	Cod. fabbrica	Tipo	Descrizione	Conf. (pz)	Imballo (pz)	Pallet (pz)	€/pz
9909-2710-05	161005	ANG 90 INOX	26x4	10	100	5.600	7,960
9909-2711-05	161105	ANG 45 INOX	26x4	10	100	5.600	7,960

## ANG2 S INOX

Angolare a 90°, 45°, e 60° per profili pesanti PF3S  
in scatola

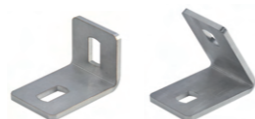

Cod. europeo	Cod. fabbrica	Tipo	Descrizione	Conf. (pz)	Imballo (pz)	Pallet (pz)	€/pz
9910-3002-60	700260	ANG2 90/S INOX	40x4 - PF3S	-	10	30.000	11,170
9910-3002-63	700263	ANG2 45/S INOX	40x4 - PF3S	-	10	30.000	11,460
9910-3002-66	700266	ANG2 60/S INOX	40x4 - PF3S	-	10	30.000	11,460

## ANS 90 2D INOX

Angolare connessione rapida 2D INOX per profilo PF3 INOX  
in scatola



Cod. europeo	Cod. fabbrica	Tipo	Descrizione	Conf. (pz)	Imballo (pz)	Pallet (pz)	€/pz
9909-2710-36	161036	ANS 90 2D INOX	2 vie - PF3 INOX	-	5	900	55,470

## PABS INOX

Piastra base a due fori per PF3 INOX  
in scatola



Cod. europeo	Cod. fabbrica	Tipo	Descrizione	Conf. (pz)	Imballo (pz)	Pallet (pz)	€/pz
9909-2612-16	161216	PABS INOX	2 fori - PF3 inox	-	5	600	95,650

## DRP INOX

Dado a rombo INOX per profili pesanti PF3S  
in scatola



Cod. europeo	Cod. fabbrica	Tipo	Descrizione	Conf. (pz)	Imballo (pz)	Pallet (pz)	€/pz
9910-3503-10	700310	DRP 8 INOX	M8	-	25	75.000	6,240
9910-3503-20	700320	DRP 10 INOX	M10	-	25	75.000	7,750

## DMP INOX

Bullone testa a martello INOX per profili pesanti PF3S  
in scatola



Cod. europeo	Cod. fabbrica	Tipo	Descrizione	Conf. (pz)	Imballo (pz)	Pallet (pz)	€/pz
9910-3503-45	700345	DMP 10x25 INOX	M10x25	-	25	75.000	9,590

## JBR 10 INOX

Bullone rapido di connessione INOX per profilo PF3S INOX  
in buste trasparenti



Cod. europeo	Cod. fabbrica	Tipo	Descrizione	Conf. (pz)	Imballo (pz)	Pallet (pz)	€/pz
9909-2719-51	161951	JBR 10 INOX	Per PF3 INOX	5	25	4.500	13,170

## JDA

Dado a rombo rapido a farfalla INOX per profilo PF3 INOX in buste trasparenti



Cod. europeo	Cod. fabbrica	Tipo	Descrizione	Conf. (pz)	Imballo (pz)	Pallet (pz)	€/pz
9909-2719-63	161963	JDA 8 INOX	M8 x PF3 INOX	5	25	8400	6,790
9909-2719-66	161966	JDA 10 INOX	M10 x PF3 INOX	5	25	8400	8,450

## JDRP INOX

Piastra con dado a rombo rapido INOX per profilo PF3 INOX in buste trasparenti

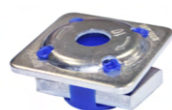

Cod. europeo	Cod. fabbrica	Tipo	Descrizione	Conf. (pz)	Imballo (pz)	Pallet (pz)	€/pz
9909-2719-73	161973	JDRP 8 INOX	M8 x PF3 INOX	5	25	8400	12,050
9909-2719-76	161976	JDRP 10 INOX	M10 x PF3 INOX	5	25	8400	12,310

## CON/S INOX

Congiunzione per profilo pesante PF3S INOX in buste trasparenti



Cod. europeo	Cod. fabbrica	Tipo	Descrizione	Conf. (pz)	Imballo (pz)	Pallet (pz)	€/pz
9910-3002-55	700255	CON/S INOX	180x35x2 - PF3S INOX	1	5	600	58,360

## SSU INOX

Sospensione snodata universale INOX in scatola



Cod. europeo	Cod. fabbrica	Tipo	Conf. (pz)	Imballo (pz)	Pallet (pz)	€/pz
9910-3002-80	700280	SSU INOX	-	5	900	33,870

## ANG 180/S INOX

Connessione ad angolo variabile per profili pesanti in buste trasparenti



Cod. europeo	Cod. fabbrica	Tipo	Descrizione	Conf. (pz)	Imballo (pz)	Pallet (pz)	€/pz
9910-3002-75	700275	ANG 180/S INOX	PF3S inox PF3S alluminio	1	5	280	43,150

## BU INOX

Bullone INOX a testa esagonale in buste trasparenti



Cod. europeo	Cod. fabbrica	Tipo	Descrizione	Conf. (pz)	Imballo (pz)	Pallet (pz)	€/pz
9909-2745-05	164505	BU 8 INOX	M8x16	10	200	24.000	1,040
9910-3503-70	700370	BU 8X20 INOX	M8x20	10	100	18.000	1,030
9910-3503-76	700376	BU 10x25 INOX	M10x25	10	100	18.000	1,880

## RO INOX

Rondella INOX in buste trasparenti



Cod. europeo	Cod. fabbrica	Tipo	Descrizione	Conf. (pz)	Imballo (pz)	Pallet (pz)	€/pz
9909-2740-10	164010	RO 6 INOX	24x6,4x1,6	10	200	36.000	1,160
9909-2741-10	164110	RO 8 INOX	24x9,0x2,0	10	200	36.000	1,160
9909-2742-10	164210	RO 10 INOX	30x11x2,5	10	200	36.000	1,630
9909-2742-51	164251	RO 12 INOX	36x13x3,0	10	100	33.600	1,630

## D INOX

Dado esagonale INOX  
in buste trasparenti



Cod. europeo	Cod. fabbrica	Tipo	Descrizione	Conf. (pz)	Imballo (pz)	Pallet (pz)	€/pz
9909-2725-10	162510	D 6 INOX	M6	10	200	24.000	0,510
9909-2726-10	162610	D 8 INOX	M8	10	200	24.000	0,860
9909-2727-10	162710	D 10 INOX	M10	10	200	24.000	1,550
9909-2727-51	162751	D 12 INOX	M12	10	100	33.600	1,710

## TR INOX

Tronchetto filettato INOX  
in buste trasparenti



Cod. europeo	Cod. fabbrica	Tipo	Descrizione	Conf. (pz)	Imballo (pz)	Pallet (pz)	€/pz
9909-2732-01	163201	TR 6 INOX	M6x32	10	200	24.000	0,820
9909-2733-01	163301	TR 8 INOX	M8x32	10	200	24.000	1,160
9909-2735-01	163501	TR 10 INOX	M10x32	10	200	24.000	1,570

**SIMPLIFY  
YOUR  
WORK**

## 8. FISSAGGI PER SOLARE TERMICO



La gamma solare termico di GIA include prodotti in acciaio Inox 304 e alluminio, con staffe robuste e regolabili dotate di piastre rinforzate. La progettazione consente fissaggi stabili, sicuri e adattabili a diverse configurazioni di tetto, garantendo affidabilità e conformità agli standard di settore.

SCOPRI DI PIÙ,  
INQUADRA IL  
QR CODE

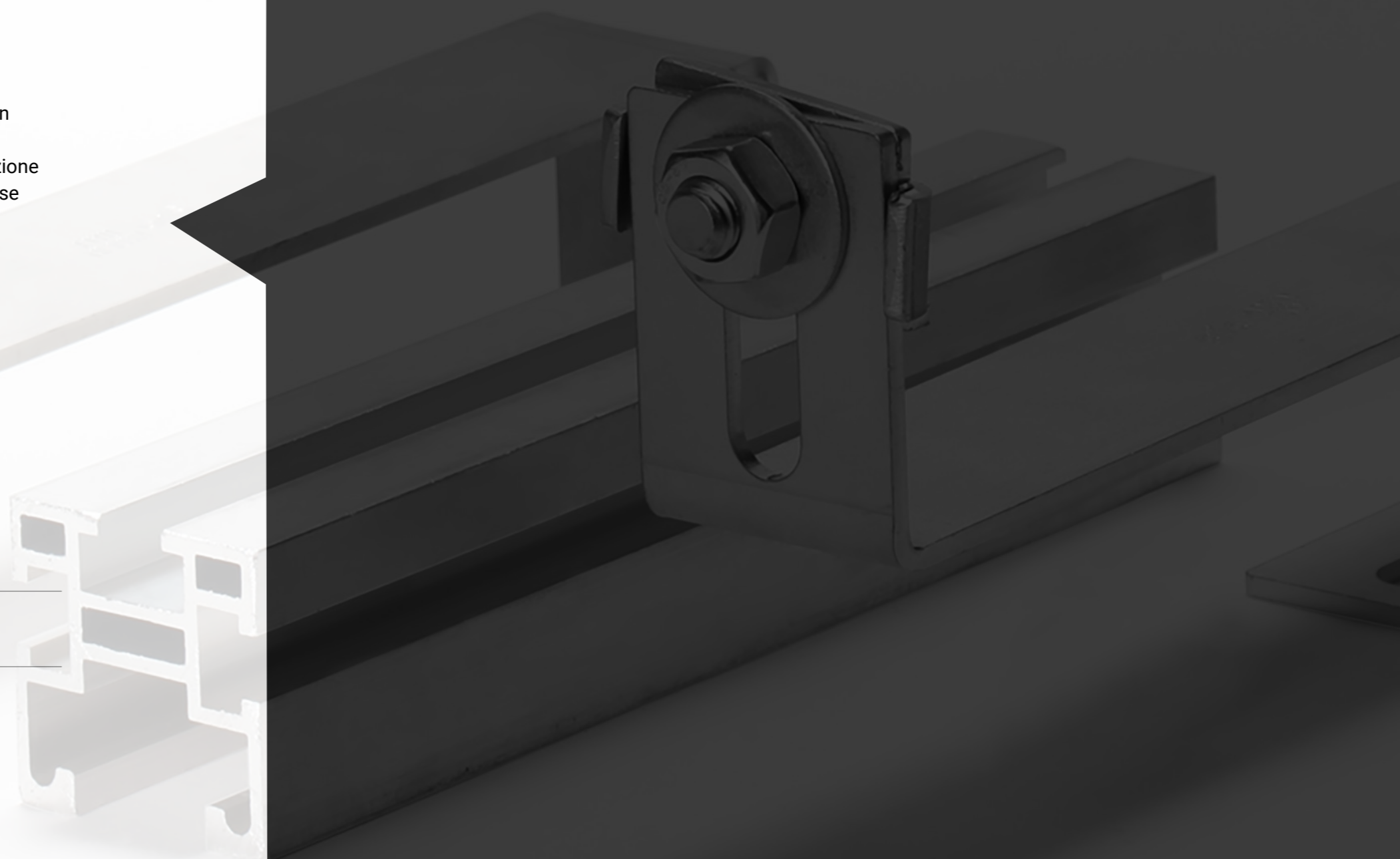

## KIT 1 INOX

Fissaggio laterale e frontale in scatola



Cod. europeo	Cod. fabbrica	Tipo	Confezione (pz)	Imballo (conf)	Pallet (conf)	€/conf
9910-1000-10	700010	KIT 1 INOX	-	1	35	553,900

Contiene

9910-2002-39	700239	PF3S INOX MT1,5	2			
9910-3805-00	700500	MAN INOX	4			
9910-3805-20	700520	STAFF1	2			
9910-3503-45	700345	DMP 10X25 INOX	6			
9909-2727-10	162710	D 10 INOX	6			
9909-2742-10	164210	RO 10 INOX	6			
9909-5003-50	160350	TPF 3	4			

## KIT 2 INOX

Fissaggio frontale e posteriore in scatola



Cod. europeo	Cod. fabbrica	Tipo	Confezione (pz)	Imballo (conf)	Pallet (conf)	€/conf
9910-1000-15	700015	KIT 2 INOX	-	1	35	564,400

Contiene

9910-2002-39	700239	PF3S INOX MT1,5	2			
9910-3805-25	700525	STAFF2	4			
9910-3503-45	700345	DMP 10x25 INOX	8			
9909-2727-10	162710	D 10 INOX	8			
9909-2742-10	164210	RO 10 INOX	8			
9909-5003-50	160350	TPF 3	4			

## KIT 3 ALLUMINIO

Fissaggio laterale e frontale in scatola



Cod. europeo	Cod. fabbrica	Tipo	Confezione (pz)	Imballo (conf)	Pallet (conf)	€/conf
9910-1000-30	700030	KIT 3 ALLUMINIO	-	1	35	345,500

Contiene

9910-2002-39	700239	PF3S ALLUMINIO MT1,5	2			
9910-3805-00	700500	MAN INOX	4			
9910-3805-20	700520	STAFF1	2			
9910-3503-76	700376	BU 10X25 INOX	6			
9909-2727-10	162710	D 10 INOX	6			
9909-2742-10	164210	RO 10 INOX	6			

## KIT 4 ALLUMINIO

Fissaggio frontale e posteriore in scatola



Cod. europeo	Cod. fabbrica	Tipo	Confezione (pz)	Imballo (conf)	Pallet (conf)	€/conf
9910-1000-35	700035	KIT 4 ALLUMINIO	-	1	35	339,700

Contiene

9910-2002-39	700239	PF3S ALLUMINIO MT1,5	2			
9910-3805-25	700525	STAFF2	4			
9910-3503-76	700376	BU 10X25 INOX	8			
9909-2727-10	162710	D 10 INOX	8			
9909-2742-10	164210	RO 10 INOX	8			

## PF3S ALLUMINIO

Profilo pesante in Alluminio in fasci



Cod. europeo	Cod. fabbrica	Tipo	Descrizione	Conf. (pz)	Imballo (pz)	Pallet (pz)	€/pz
9910-2002-39	700239	PF3S ALLUMINIO MT1,5	41x41 - 1,5 mt	-	4	4	69,710
9910-2002-40	700240	PF3S ALLUMINIO MT3	41x41 - 3,0 mt	-	4	4	131,100
9910-2002-41	700241	PF3S ALLUMINIO MT6	41x41 - 6,0 mt	-	4	4	260,700

\* Prezzo unitario franco partenza (spese di trasporto da concordare)

## CON/AS

Congiunzione profilo pesante in Alluminio in buste trasparenti



Cod. europeo	Cod. fabbrica	Tipo	Descrizione	Conf. (pz)	Imballo (pz)	Pallet (pz)	€/pz
9910-3002-57	700257	CON/AS	135x13x5 - PF3S ALLUMINIO	2	5	1680	45,210

## BRU INOX

Vite INOX testa cilindrica con esagono in buste trasparenti



Cod. europeo	Cod. fabbrica	Tipo	Descrizione	Conf. (pz)	Imballo (pz)	Pallet (pz)	€/pz
9910-3503-62	700362	BRU 8x30 INOX	M8x30	10	100	18.000	1,560
9910-3503-67	700367	BRU 10x30 INOX	M10x30	10	100	18.000	2,540

## BUL INOX

Bullone INOX testa esagonale filetto legno in buste trasparenti



Cod. europeo	Cod. fabbrica	Tipo	Descrizione	Conf. (pz)	Imballo (pz)	Pallet (pz)	€/pz
9910-3503-85	700385	BUL 8x60 INOX	M8x60	10	100	18.000	2,540

## MAN INOX

Manina regolabile di fermo laterale pannello in buste trasparenti



Cod. europeo	Cod. fabbrica	Tipo	Conf. (pz)	Imballo (pz)	Pallet (pz)	€/pz
9910-3805-00	700500	MAN INOX	4	20	2400	22,530

## STAFF 1

Staffa inferiore di sicurezza per pannelli sagomati sul bordo in buste trasparenti



Cod. europeo	Cod. fabbrica	Tipo	Conf. (pz)	Imballo (pz)	Pallet (pz)	€/pz
9910-3805-20	700520	STAFF 1	2	6	336	92,490

## STAFF 2

Staffa di sicurezza e fissaggio per pannelli a bordo liscio in buste trasparenti



Cod. europeo	Cod. fabbrica	Tipo	Conf. (pz)	Imballo (pz)	Pallet (pz)	€/pz
9910-3805-25	700525	STAFF 2	2	6	336	83,440

## PRT INOX

Piastra regolabile e rinforzata per tetto con tegole in scatola



Cod. europeo	Cod. fabbrica	Tipo	Descrizione	Conf. (pz)	Imballo (pz)	Pallet (pz)	€/pz
9910-3906-10	700610	PRT 5 INOX	sp. 5 mm	-	4	480	54,720
9910-3906-12	700612	PRT 8 INOX	sp. 8 mm	-	4	480	72,830

## PRT INOX

Piastra regolabile e rinforzata per tetto con doppi coppi in scatola



Cod. europeo	Cod. fabbrica	Tipo	Conf. (pz)	Imballo (pz)	Pallet (pz)	€/pz
9910-3906-30	700630	PRT 6 INOX	-	4	224	71,690

## PT 4 INOX

Piastra per tetto con pietre e tegole piatte in scatola



Cod. europeo	Cod. fabbrica	Tipo	Conf. (pz)	Imballo (pz)	Pallet (pz)	€/pz
9910-3906-20	700620	PT 4 INOX	-	4	224	35,910

## PIV INOX

Piastra di connessione vite in scatola



Cod. europeo	Cod. fabbrica	Tipo	Descrizione	Conf. (pz)	Imballo (pz)	Pallet (pz)	€/pz
9910-3906-60	700660	PIV INOX	40x4	-	20	60.000	7,550

## VDF INOX

Vite doppio filetto legno/metallo con ranella EPDM in scatola



Cod. europeo	Cod. fabbrica	Tipo	Conf. (pz)	Imballo (pz)	Pallet (pz)	€/pz
9910-3906-52	700652	VDF M10x250 INOX	-	20	1120	19,180
9910-3906-57	700657	VDF M12x300 INOX	-	20	1120	22,190

## RAN EPDM

Ranella in EPDM per viti in scatola



Cod. europeo	Cod. fabbrica	Tipo	Conf. (pz)	Imballo (pz)	Pallet (pz)	€/pz
9910-3906-65	700665	RAN EPDM	-	20	60.000	2,490

**SIMPLIFY  
YOUR  
WORK**

# 9. CANALINE E ACCESSORI



Canalsplit® è la nostra canalina nata da un'idea tanto semplice quanto rivoluzionaria e accolta con entusiasmo dagli installatori. La facilità d'uso e il design elegante rendono questa canalina l'alleata perfetta per lavorare sempre meglio: ecco perché, quasi 25 anni dopo la sua concezione, la nostra canalina è ancora la più utilizzata dagli installatori.

Scegliendo Canalsplit®, avrai la certezza di acquistare un prodotto di altissima qualità e riciclabile al 100%. È inoltre disponibile un servizio di personalizzazione completo: codice, etichetta, stampa sul prodotto finito, colore e imballaggio.

Canalsplit® nasce da un brillante istinto di semplificare l'installazione. In combinazione con la nostra capacità di ascoltare i nostri clienti, questo ha trasformato il prodotto in una soluzione intelligente

SCOPRI DI PIÙ,  
INQUADRA IL  
QR CODE



## Dimensioni disponibili

A seconda delle configurazioni di installazione, il contenuto delle canaline può variare.



CANALSPLIT®



CANAL  
ICE  
LINESET  
COVERS

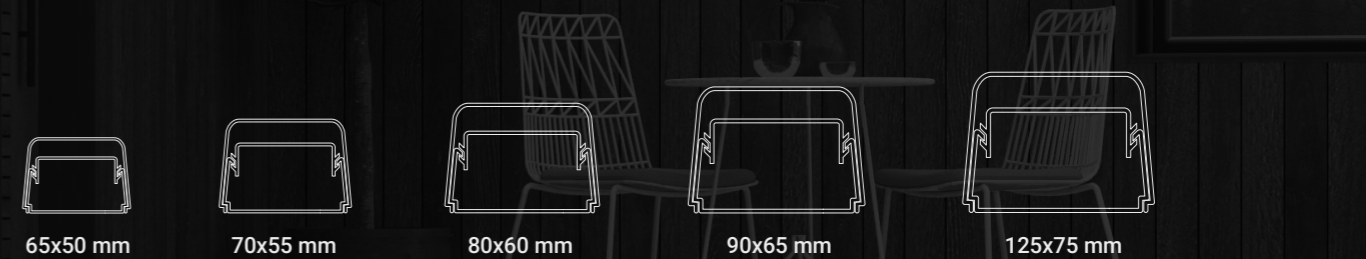

CANAL DRY

# CANALSPLIT®

## CANALINE E ACCESSORI

### CANALSPLIT®

Canalina BIANCO AVORIO con coperchio avvolgente e film barre da 2m in scatola

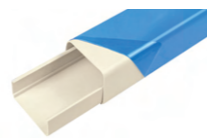

Cod. europeo	Cod. fabbrica	Tipo	Descrizione	Colore	Conf. (m)	Imballo (m)	Pallet (m)	€/m
1101-0106-01	0612 BCF	CANALSPLIT 60x45 AF	60x45 mm	Avorio	-	24	1152	4,690
1101-0108-01	0712 BCF	CANALSPLIT 70x55 AF	70x55 mm	Avorio	-	24	840	5,740
1101-0111-01	0812 BCF	CANALSPLIT 80x60 AF	80x60 mm	Avorio	-	16	672	6,700
1101-0112-01	0912 BCF	CANALSPLIT 90x65 AF	90x65 mm	Avorio	-	16	576	7,890
1101-0114-01	1212 BCF	CANALSPLIT 110x75 AF	110x75 mm	Avorio	-	8	384	9,860
1101-0116-01	1412 BCF	CANALSPLIT 140x90 AF	140x90 mm	Avorio	-	8	280	15,330

### CANALSPLIT®

Canalina BIANCO PURO con coperchio avvolgente e film barre da 2m in scatola



Cod. europeo	Cod. fabbrica	Tipo	Descrizione	Colore	Conf. (m)	Imballo (m)	Pallet (m)	€/m
1101-0106-02	0612 BCF-W	CANALSPLIT 60x45 BPF	60x45 mm	Bianco Puro	-	24	1152	4,690
1101-0108-02	0712 BCF-W	CANALSPLIT 70x55 BPF	70x55 mm	Bianco Puro	-	24	840	5,740
1101-0111-02	0812 BCF-W	CANALSPLIT 80x60 BPF	80x60 mm	Bianco Puro	-	16	672	6,700
1101-0112-02	0912 BCF-W	CANALSPLIT 90x65 BPF	90x65 mm	Bianco Puro	-	16	576	7,890
1101-0114-02	1212 BCF-W	CANALSPLIT 110x75 BPF	110x75 mm	Bianco Puro	-	8	384	9,860
1101-0116-02	1412 BCF-W	CANALSPLIT 140x90 BPF	140x90 mm	Bianco Puro	-	8	280	15,330



### CANALSPLIT®

Canalina MARRONE con coperchio avvolgente e film barre da 2m in scatola

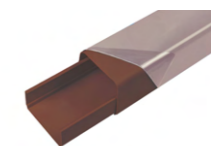

Cod. europeo	Cod. fabbrica	Tipo	Descrizione	Colore	Conf. (m)	Imballo (m)	Pallet (m)	€/m
1101-0111-05	0812 BCF-M	CANALSPLIT 80x60 M	80x60 mm	Marrone	-	16	672	9,430

### CANALSPLIT®

Canalina NERO con coperchio avvolgente e film barre da 2m in scatola

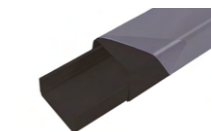

Cod. europeo	Cod. fabbrica	Tipo	Descrizione	Colore	Conf. (m)	Imballo (m)	Pallet (m)	€/m
1101-0111-03	0812 BCF-B	CANALSPLIT 80x60 N	80x60 mm	Nero	-	16	672	10,670

### CANALSPLIT®

Canalina GRIGIO SCURO con coperchio avvolgente e film barre da 2m in scatola

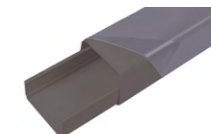

Cod. europeo	Cod. fabbrica	Tipo	Descrizione	Colore	Conf. (m)	Imballo (m)	Pallet (m)	€/m
1101-0111-04	0812 BCF-G	CANALSPLIT 80x60 G	80x60 mm	Grigio scuro	-	16	672	10,670



## SB SPLIT

Supporto di bloccaggio  
in scatola



Cod. europeo	Cod. fabbrica	Tipo	Descrizione	Colore	Conf. (pz)	Imballo (pz)	Pallet (pz)	€/pz
1101-0306-01	0603 ST	SB SPLIT 60x45	60x45 mm	Giallo	1	30	12000	0,400
1101-0308-01	0703 ST	SB SPLIT 70x55	70x55 mm	Arancione	1	30	7200	0,460
1101-0310-01	0803 ST	SB SPLIT 80x60	80x60 mm	Rosso	1	30	7200	0,470
1101-0312-01	0903 ST	SB SPLIT 90x65	90x65 mm	Blu	1	30	7200	0,510
1101-0314-01	1203 ST	SB SPLIT 110x75	110x75 mm	Verde	1	20	4800	0,550
1101-0316-01	1403 ST	SB SPLIT 140x90	140x90 mm	Avorio	1	20	3840	0,720

## CP SPLIT

Curva piana 90°  
in scatola

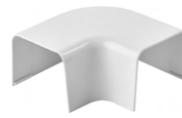

Cod. europeo	Cod. fabbrica	Tipo	Descrizione	Colore	Conf. (pz)	Imballo (pz)	Pallet (pz)	€/pz
1101-0706-01	0607 CP	CP SPLIT 60x45 A	60x45 mm	Avorio	1	10	2400	3,280
1101-0708-01	0707 CP	CP SPLIT 70x55 A	70x55 mm	Avorio	1	10	1920	3,540
1101-0711-01	0807 CP	CP SPLIT 80x60 A	80x60 mm	Avorio	1	8	1536	4,540
1101-0712-01	0907 CP	CP SPLIT 90x65 A	90x65 mm	Avorio	1	8	912	4,810
1101-0714-01	1207 CP	CP SPLIT 110x75 A	110x75 mm	Avorio	1	6	684	5,920
1101-0716-01	1407 CP	CP SPLIT 140x90 A	140x90 mm	Avorio	1	6	420	8,300
1101-0706-02	0607 CP-W	CP SPLIT 60x45 BP	60x45 mm	Bianco	1	10	2400	3,280
1101-0708-02	0707 CP-W	CP SPLIT 70x55 BP	70x55 mm	Bianco	1	10	1920	3,540
1101-0711-02	0807 CP-W	CP SPLIT 80x60 BP	80x60 mm	Bianco	1	8	1536	4,540
1101-0712-02	0907 CP-W	CP SPLIT 90x65 BP	90x65 mm	Bianco	1	8	912	4,810
1101-0714-02	1207 CP-W	CP SPLIT 110x75 BP	110x75 mm	Bianco	1	6	684	5,920
1101-0716-02	1407 CP-W	CP SPLIT 140x90 BP	140x90 mm	Bianco	1	6	420	8,300
1101-0711-05	0807 CP-M	CP SPLIT 80x60 M	80x60 mm	Marrone	1	8	1536	5,100
1101-0711-03	0807 CP-B	CP SPLIT 80x60 N	80x60 mm	Nero	1	8	1536	5,270
1101-0711-04	0807 CP-G	CP SPLIT 80x60 G	80x60 mm	Grigio	1	8	1536	5,270

## CM SPLIT

Curva terminale a muro  
in scatola



Cod. europeo	Cod. fabbrica	Tipo	Descrizione	Colore	Conf. (pz)	Imballo (pz)	Pallet (pz)	€/pz
1101-0906-01	0609 CM	CM SPLIT 60x45 A	60x45 mm	Avorio	1	9	2160	3,810
1101-0908-01	0709 CM	CM SPLIT 70x55 A	70x55 mm	Avorio	1	9	1728	4,050
1101-0911-01	0809 CM	CM SPLIT 80x60 A	80x60 mm	Avorio	1	6	1440	4,720
1101-0912-01	0909 CM	CM SPLIT 90x65 A	90x65 mm	Avorio	1	6	1152	5,020
1101-0914-01	1209 CM	CM SPLIT 110x75 A	110x75 mm	Avorio	1	4	768	5,850
1101-0916-01	1409 CM	CM SPLIT 140x90 A	140x90 mm	Avorio	1	4	392	8,170
1101-0906-02	0609 CM-W	CM SPLIT 60x45 BP	60x45 mm	Bianco	1	9	2160	3,810
1101-0908-02	0709 CM-W	CM SPLIT 70x55 BP	70x55 mm	Bianco	1	9	1728	4,050
1101-0911-02	0809 CM-W	CM SPLIT 80x60 BP	80x60 mm	Bianco	1	6	1440	4,720
1101-0912-02	0909 CM-W	CM SPLIT 90x65 BP	90x65 mm	Bianco	1	6	1152	5,020
1101-0914-02	1209 CM-W	CM SPLIT 110x75 BP	110x75 mm	Bianco	1	4	768	5,850
1101-0916-02	1409 CM-W	CM SPLIT 140x90 BP	140x90 mm	Bianco	1	4	392	8,170
1101-0911-05	0809 CM-M	CM SPLIT 80x60 M	80x60 mm	Marrone	1	6	1440	5,790
1101-0911-03	0809 CM-B	CM SPLIT 80x60 N	80x60 mm	Nero	1	6	1440	6,050
1101-0911-04	0809 CM-G	CM SPLIT 80x60 G	80x60 mm	Grigio	1	6	1440	6,050

## AI SPLIT

Raccordo angolo interno 90°  
in scatola



Cod. europeo	Cod. fabbrica	Tipo	Descrizione	Colore	Conf. (pz)	Imballo (pz)	Pallet (pz)	€/pz
1101-0506-01	0605 IA	AI SPLIT 60x45 A	60x45 mm	Avorio	1	8	1920	2,850
1101-0508-01	0705 IA	AI SPLIT 70x55 A	70x55 mm	Avorio	1	8	1536	3,070
1101-0511-01	0805 IA	AI SPLIT 80x60 A	80x60 mm	Avorio	1	6	1152	3,280
1101-0512-01	0905 IA	AI SPLIT 90x65 A	90x65 mm	Avorio	1	6	912	3,490
1101-0514-01	1205 IA	AI SPLIT 110x75 A	110x75 mm	Avorio	1	4	608	4,130
1101-0516-01	1405 IA	AI SPLIT 140x90 A	140x90 mm	Avorio	1	4	392	5,370
1101-0506-02	0605 AI-W	AI SPLIT 60x45 BP	60x45 mm	Bianco	1	8	1920	2,850
1101-0508-02	0705 AI-W	AI SPLIT 70x55 BP	70x55 mm	Bianco	1	8	1536	3,070
1101-0511-02	0805 AI-W	AI SPLIT 80x60 BP	80x60 mm	Bianco	1	6	1152	3,280
1101-0512-02	0905 AI-W	AI SPLIT 90x65 BP	90x65 mm	Bianco	1	6	912	3,490
1101-0514-02	1205 AI-W	AI SPLIT 110x75 BP	110x75 mm	Bianco	1	4	608	4,130
1101-0516-02	1405 AI-W	AI SPLIT 140x90 BP	140x90 mm	Bianco	1	4	392	5,370
1101-0511-05	0805 AI-M	AI SPLIT 80x60 M	80x60 mm	Marrone	1	6	1152	3,680
1101-0511-03	0805 AI-B	AI SPLIT 80x60 N	80x60 mm	Nero	1	6	1152	3,840
1101-0511-04	0805 AI-G	AI SPLIT 80x60 G	80x60 mm	Grigio	1	6	1152	3,840

## AE SPLIT

Raccordo angolo esterno 90°  
in scatola



Cod. europeo	Cod. fabbrica	Tipo	Descrizione	Colore	Conf. (pz)	Imballo (pz)	Pallet (pz)	€/pz
1101-0606-01	0606 EA	AE SPLIT 60x45 A	60x45 mm	Avorio	1	12	2880	2,850
1101-0608-01	0706 EA	AE SPLIT 70x55 A	70x55 mm	Avorio	1	12	2304	3,070
1101-0611-01	0806 EA	AE SPLIT 80x60 A	80x60 mm	Avorio	1	9	1728	3,280
1101-0612-01	0906 EA	AE SPLIT 90x65 A	90x65 mm	Avorio	1	9	1026	3,490
1101-0614-01	1206 EA	AE SPLIT 110x75 A	110x75 mm	Avorio	1	6	1152	4,130
1101-0616-01	1406 EA	AE SPLIT 140x90 A	140x90 mm	Avorio	1	6	588	5,370
1101-0606-02	0606 AE-W	AE SPLIT 60x45 BP	60x45 mm	Bianco	1	12	2880	2,850
1101-0608-02	0706 AE-W	AE SPLIT 70x55 BP	70x55 mm	Bianco	1	12	2304	3,070
1101-0611-02	0806 AE-W	AE SPLIT 80x60 BP	80x60 mm	Bianco	1	9	1728	3,280
1101-0612-02	0906 AE-W	AE SPLIT 90x65 BP	90x65 mm	Bianco	1	9	1026	3,490
1101-0614-02	1206 AE-W	AE SPLIT 110x75 BP	110x75 mm	Bianco	1	6	1152	4,130
1101-0616-02	1406 AE-W	AE SPLIT 140x90 BP	140x90 mm	Bianco	1	6	588	5,370
1101-0611-05	0806 AE-M	AE SPLIT 80x60 M	80x60 mm	Marrone	1	9	1728	3,680
1101-0611-03	0806 AE-B	AE SPLIT 80x60 N	80x60 mm	Nero	1	9	1728	3,840
1101-0611-04	0806 AE-G	AE SPLIT 80x60 G	80x60 mm	Grigio	1	9	1728	3,840

## TT SPLIT

Tappo di chiusura terminale  
in scatola



Cod. europeo	Cod. fabbrica	Tipo	Descrizione	Colore	Conf. (pz)	Imballo (pz)	Pallet (pz)	€/pz
1101-0806-01	0608 TT	TT SPLIT 60x45 A	60x45 mm	Avorio	1	12	2880	2,770
1101-0808-01	0708 TT	TT SPLIT 70x55 A	70x55 mm	Avorio	1	12	2880	2,860
1101-0811-01	0808 TT	TT SPLIT 80x60 A	80x60 mm	Avorio	1	9	2160	3,180
1101-0812-01	0908 TT	TT SPLIT 90x65 A	90x65 mm	Avorio	1	9	2160	3,290
1101-0814-01	1208 TT	TT SPLIT 110x75 A	110x75 mm	Avorio	1	6	912	4,160
1101-0806-02	0608 TT-W	TT SPLIT 60x45 BP	60x45 mm	Bianco	1	12	2880	2,770
1101-0808-02	0708 TT-W	TT SPLIT 70x55 BP	70x55 mm	Bianco	1	12	2880	2,860
1101-0811-02	0808 TT-W	TT SPLIT 80x60 BP	80x60 mm	Bianco	1	9	2160	3,180
1101-0812-02	0908 TT-W	TT SPLIT 90x65 BP	90x65 mm	Bianco	1	9	2160	3,290
1101-0814-02	1208 TT-W	TT SPLIT 110x75 BP	110x75 mm	Bianco	1	6	912	4,160
1101-0811-05	0808 TT-M	TT SPLIT 80x60 M	80x60 mm	Marrone	1	9	2160	3,560
1101-0811-03	0808 TT-B	TT SPLIT 80x60 N	80x60 mm	Nero	1	9	2160	3,730
1101-0811-04	0808 TT-G	TT SPLIT 80x60 G	80x60 mm	Grigio	1	9	2160	3,730



## PM SPLIT

Passaggio a muro  
in scatola



Cod. europeo	Cod. fabbrica	Tipo	Descrizione	Colore	Conf. (pz)	Imballo (pz)	Pallet (pz)	€/pz
1101-1006-01	0610 PM	PM SPLIT 60x45 A	60x45 mm	Avorio	1	10	4000	2,850
1101-1008-01	0710 PM	PM SPLIT 70x55 A	70x55 mm	Avorio	1	10	4000	3,000
1101-1011-01	0810 PM	PM SPLIT 80x60 A	80x60 mm	Avorio	1	16	3840	3,630
1101-1012-01	0910 PM	PM SPLIT 90x65 A	90x65 mm	Avorio	1	16	3840	3,860
1101-1014-01	1210 PM	PM SPLIT 110x75 A	110x75 mm	Avorio	1	8	1920	4,820
1101-1016-01	1410 PM	PM SPLIT 140x90 A	140x90 mm	Avorio	1	8	1536	6,760
1101-1006-02	0610 PM-W	PM SPLIT 60x45 BP	60x45 mm	Bianco	1	10	4000	2,850
1101-1008-02	0710 PM-W	PM SPLIT 70x55 BP	70x55 mm	Bianco	1	10	4000	3,000
1101-1011-02	0810 PM-W	PM SPLIT 80x60 BP	80x60 mm	Bianco	1	16	3840	3,630
1101-1012-02	0910 PM-W	PM SPLIT 90x65 BP	90x65 mm	Bianco	1	16	3840	3,860
1101-1014-02	1210 PM-W	PM SPLIT 110x75 BP	110x75 mm	Bianco	1	8	1920	4,820
1101-1016-02	1410 PM-W	PM SPLIT 140x90 BP	140x90 mm	Bianco	1	8	1536	6,760
1101-1011-05	0810 PM-M	PM SPLIT 80x60 M	80x60 mm	Marrone	1	16	3840	4,420
1101-1011-03	0810 PM-B	PM SPLIT 80x60 N	80x60 mm	Nero	1	16	3840	4,640
1101-1011-04	0810 PM-G	PM SPLIT 80x60 G	80x60 mm	Grigio	1	16	3840	4,640

## GC SPLIT

Giunto coperchio  
in scatola



Cod. europeo	Cod. fabbrica	Tipo	Descrizione	Colore	Conf. (pz)	Imballo (pz)	Pallet (pz)	€/pz
1101-0406-01	0604 GC	GC SPLIT 60x45 A	60x45 mm	Avorio	1	30	12000	1,480
1101-0408-01	0704 GC	GC SPLIT 70x55 A	70x55 mm	Avorio	1	30	7200	1,640
1101-0411-01	0804 GC	GC SPLIT 80x60 A	80x60 mm	Avorio	1	30	7200	1,960
1101-0412-01	0904 GC	GC SPLIT 90x65 A	90x65 mm	Avorio	1	30	7200	2,090
1101-0414-01	1204 GC	GC SPLIT 110x75 A	110x75 mm	Avorio	1	20	4800	2,230
1101-0416-01	1404 GC	GC SPLIT 140x90 A	140x90 mm	Avorio	1	20	3840	2,880
1101-0406-02	0604 GC-W	GC SPLIT 60x45 BP	60x45 mm	Bianco	1	30	12000	1,480
1101-0408-02	0704 GC-W	GC SPLIT 70x55 BP	70x55 mm	Bianco	1	30	7200	1,640
1101-0411-02	0804 GC-W	GC SPLIT 80x60 BP	80x60 mm	Bianco	1	30	7200	1,960
1101-0412-02	0904 GC-W	GC SPLIT 90x65 BP	90x65 mm	Bianco	1	30	7200	2,090
1101-0414-02	1204 GC-W	GC SPLIT 110x75 BP	110x75 mm	Bianco	1	20	4800	2,230
1101-0416-02	1404 GC-W	GC SPLIT 140x90 BP	140x90 mm	Bianco	1	20	3840	2,880
1101-0411-05	0804 GC-M	GC SPLIT 80x60 M	80x60 mm	Marrone	1	30	7200	2,200
1101-0411-03	0804 GC-B	GC SPLIT 80x60 N	80x60 mm	Nero	1	30	7200	2,300
1101-0411-04	0804 GC-G	GC SPLIT 80x60 G	80x60 mm	Grigio	1	30	7200	2,300



## RI SPLIT

Riduzione  
in scatola



Cod. europeo	Cod. fabbrica	Tipo	Descrizione	Colore	Conf. (pz)	Imballo (pz)	Pallet (pz)	€/pz
1101-1411-01	8060 RI	RI SPLIT 80-60 A	80-60	Avorio	1	12	2880	2,610
1101-1411-03	8070 RI	RI SPLIT 80-70 A	80-70	Avorio	1	12	2880	2,610
1101-1412-01	9060 RI	RI SPLIT 90-60 A	90-60	Avorio	1	12	2880	2,790
1101-1412-03	9070 RI	RI SPLIT 90-70 A	90-70	Avorio	1	12	2880	2,790
1101-1414-01	1280 RI	RI SPLIT 110-80 A	110-80	Avorio	1	8	1920	2,970
1101-1414-03	1290 RI	RI SPLIT 110-90 A	110-90	Avorio	1	8	1920	3,730
1101-1416-01	1412 RI	RI SPLIT 140-110 A	140-110	Avorio	1	8	1920	5,210
1101-1411-02	8060 RI-W	RI SPLIT 80-60 BP	80-60	Bianco	1	12	2880	2,610
1101-1411-04	8070 RI-W	RI SPLIT 80-70 BP	80-70	Bianco	1	12	2880	2,610
1101-1412-02	9060 RI-W	RI SPLIT 90-60 BP	90-60	Bianco	1	12	2880	2,790
1101-1412-04	9070 RI-W	RI SPLIT 90-70 BP	90-70	Bianco	1	12	2880	2,790
1101-1414-02	1280 RI-W	RI SPLIT 110-80 BP	110-80	Bianco	1	8	1920	2,970
1101-1414-04	1290 RI-W	RI SPLIT 110-90 BP	110-90	Bianco	1	8	1920	3,730
1101-1416-02	1412 RI-W	RI SPLIT 140-110 BP	140-110	Bianco	1	8	1920	5,210

## RM SPLIT

Raccordo a muro  
in scatola



Cod. europeo	Cod. fabbrica	Tipo	Descrizione	Colore	Conf. (pz)	Imballo (pz)	Pallet (pz)	€/pz
1101-1711-01	0816 RM	RM SPLIT 80x60 A	80x60 mm	Avorio	1	6	684	5,350
1101-1712-01	0916 RM	RM SPLIT 90x65 A	90x65 mm	Avorio	1	6	684	5,690
1101-1711-02	0816 RM-W	RM SPLIT 80x60 BP	80x60 mm	Bianco	1	6	684	5,350
1101-1712-02	0916 RM-W	RM SPLIT 90x65 BP	90x65 mm	Bianco	1	6	684	5,690



## T SPLIT

Derivazione a "T"  
in scatola



Cod. europeo	Cod. fabbrica	Tipo	Descrizione	Colore	Conf. (pz)	Imballo (pz)	Pallet (pz)	€/pz
1101-1311-01	0813 DT	T SPLIT 80x60 A	80x60 mm	Avorio	1	4	768	7,220
1101-1312-01	0913 DT	T SPLIT 90x65 A	90x65 mm	Avorio	1	4	768	7,800
1101-1314-01	1213 DT	T SPLIT 110x75 A	110x75 mm	Avorio	1	4	456	9,020
1101-1316-01	1413 DT	T SPLIT 140x90 A	140x90 mm	Avorio	1	2	330	12,620
1101-1311-02	0813 DT-W	T SPLIT 80x60 BP	80x60 mm	Bianco	1	4	768	7,220
1101-1312-02	0913 DT-W	T SPLIT 90x65 BP	90x65 mm	Bianco	1	4	768	7,800
1101-1314-02	1213 DT-W	T SPLIT 110x75 BP	110x75 mm	Bianco	1	4	456	9,020
1101-1316-02	1413 DT-W	T SPLIT 140x90 BP	140x90 mm	Bianco	1	2	330	12,620
1101-1311-05	0813 DT-M	T SPLIT 80x60 M	80x60 mm	Marrone	1	4	768	8,980
1101-1311-03	0813 DT-B	T SPLIT 80x60 N	80x60 mm	Nero	1	4	768	9,210
1101-1311-04	0813 DT-G	T SPLIT 80x60 G	80x60 mm	Grigio	1	4	768	9,210

## CR SPLIT

Curva piana regolabile  
in scatola



Cod. europeo	Cod. fabbrica	Tipo	Descrizione	Colore	Conf. (pz)	Imballo (pz)	Pallet (pz)	€/pz
1101-2306-01	0622 PR	CR SPLIT 60x45 A	60x45 mm 65°-135°	Avorio	1	8	1920	4,030
1101-2311-01	0822 PR	CR SPLIT 80x60 A	80x60 mm 65°-135°	Avorio	1	6	912	5,580
1101-2314-01	1222 PR	CR SPLIT 110x75 A	110x75 mm 65°-135°	Avorio	1	4	456	7,550
1101-2306-02	0622 PR-W	CR SPLIT 60x45 BP	60x45 mm 65°-135°	Bianco	1	8	1920	4,030
1101-2311-02	0822 PR-W	CR SPLIT 80x60 BP	80x60 mm 65°-135°	Bianco	1	6	912	5,580
1101-2314-02	1222 PR-W	CR SPLIT 110x75 BP	110x75 mm 65°-135°	Bianco	1	4	456	7,550



## IR SPLIT

Angolo interno regolabile  
in scatola

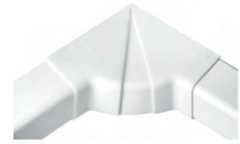

Cod. europeo	Cod. fabbrica	Tipo	Descrizione	Colore	Conf. (pz)	Imballo (pz)	Pallet (pz)	€/pz
1101-2106-01	0620 IR	IR SPLIT 60x45 A	60x45, 80°-105°	Avorio	1	6	1152	3,710
1101-2111-01	0820 IR	IR SPLIT 80x60 A	80x60, 80°-105°	Avorio	1	4	456	4,250
1101-2106-02	0620 IR-W	IR SPLIT 60x45 BP	60x45, 80°-105°	Bianco	1	6	1152	3,710
1101-2111-02	0820 IR-W	IR SPLIT 80x60 BP	80x60, 80°-105°	Bianco	1	4	456	4,250

## ER SPLIT

Angolo esterno regolabile  
in scatola

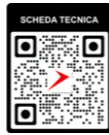

Cod. europeo	Cod. fabbrica	Tipo	Descrizione	Colore	Conf. (pz)	Imballo (pz)	Pallet (pz)	€/pz
1101-2206-01	0621 ER	ER SPLIT 60x45 A	60x45, 70°-120°	Avorio	1	8	1920	3,710
1101-2211-01	0821 ER	ER SPLIT 80x60 A	80x60, 70°-120°	Avorio	1	6	1152	4,250
1101-2206-02	0621 ER-W	ER SPLIT 60x45 BP	60x45, 70°-120°	Bianco	1	8	1920	3,710
1101-2211-02	0821 ER-W	ER SPLIT 80x60 BP	80x60, 70°-120°	Bianco	1	6	1152	4,250

## VS SPLIT

Angolo verticale sinistro  
in scatola



Cod. europeo	Cod. fabbrica	Tipo	Descrizione	Colore	Conf. (pz)	Imballo (pz)	Pallet (pz)	€/pz
1101-1506-01	0614 VS	VS SPLIT 60x45 A	60x45 mm	Avorio	1	6	1152	6,170
1101-1511-01	0814 VS	VS SPLIT 80x60 A	80x60 mm	Avorio	1	4	608	8,210
1101-1506-02	0614 VS-W	VS SPLIT 60x45 BP	60x45 mm	Bianco	1	6	1152	6,170
1101-1511-02	0814 VS-W	VS SPLIT 80x60 BP	80x60 mm	Bianco	1	4	608	8,210

## VD SPLIT

Angolo verticale destro  
in scatola



Cod. europeo	Cod. fabbrica	Tipo	Descrizione	Colore	Conf. (pz)	Imballo (pz)	Pallet (pz)	€/pz
1101-1606-01	0615 VD	VD SPLIT 60x45 A	60x45 mm	Avorio	1	6	1152	6,170
1101-1611-01	0815 VD	VD SPLIT 80x60 A	80x60 mm	Avorio	1	4	608	8,210
1101-1606-02	0615 VD-W	VD SPLIT 60x45 BP	60x45 mm	Bianco	1	6	1152	6,170
1101-1611-02	0815 VD-W	VD SPLIT 80x60 BP	80x60 mm	Bianco	1	4	608	8,210

## GF SPLIT

Giunto flessibile  
in scatola



Cod. europeo	Cod. fabbrica	Tipo	Descrizione	Colore	Conf. (pz)	Imballo (pz)	Pallet (pz)	€/pz
1101-1106-01	0611 GF	GF SPLIT 60x45 A	60x45 - L 590	Avorio	1	6	432	9,430
1101-1111-01	0811 GF	GF SPLIT 80x60 A	80x60 - L 590	Avorio	1	4	288	10,050
1101-1111-02	0811 GF-W	GF SPLIT 80x60 BP	80x60 - L 590	Bianco	1	4	288	10,050

## KF SPLIT

Kit flessibile  
in scatola

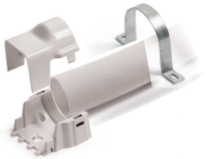

Cod. europeo	Cod. fabbrica	Tipo	Descrizione	Colore	Conf. (pz)	Imballo (pz)	Pallet (pz)	€/pz
1101-2411-01	0515.00114.072	KF 80x60	80x60 mm	Avorio	-	1	40	55,570
1101-2414-01	0515.00214.072	KF 100x75	100x75 mm	Avorio	-	1	80	67,320

## KF COPERTURA

Copertura flessibile  
in scatola

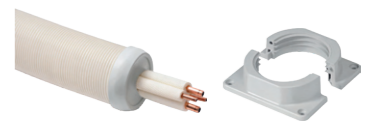

Cod. europeo	Cod. fabbrica	Tipo	Descrizione	Colore	Conf. (pz)	Imballo (pz)	Pallet (pz)	€/pz
1101-2514-01	1224 KC	KF COPERTURA 110X75	Ø 80,1 m	Avorio	-	1	40	56,460

# CANALSPLIT®

## CANALINA DI SERVIZIO E ACCESSORI

### CANALSPLIT®

Canalina di servizio BIANCO e AVORIO per copertura tubi di scarico condensa barre da 2m in scatola



Cod. europeo	Cod. fabbrica	Tipo	Descrizione	Colore	Conf. (m)	Imballo (m)	Pallet (m)	€/m
1101-0104-01	0312BC	CANALSPLIT 25x25 A	25x25 mm	Avorio	2	64	3072	1,800
1101-0105-01	0412BC	CANALSPLIT 35x30 A	35x30 mm	Avorio	2	64	3072	3,120
1111-0102-01	1818CE	CANALSPLIT 18x18 B	18x18 mm	Bianco	2	108	5184	2,260
1101-0104-02	0312BC-W	CANALSPLIT 25x25 B	25x25 mm	Bianco	2	64	3072	1,800
1101-0105-02	0412BC-W	CANALSPLIT 35x30 B	35x30 mm	Bianco	2	64	3072	3,120

### CP SPLIT

Curva piana 90° in scatola



Cod. europeo	Cod. fabbrica	Tipo	Descrizione	Colore	Conf. (pz)	Imballo (pz)	Pallet (pz)	€/pz
1101-0704-01	0307CP	CP SPLIT 25x25 A	25x25 mm	Avorio	-	20	8000	0,990
1101-0705-01	0407CP	CP SPLIT 35x30 A	35x30 mm	Avorio	-	20	4800	1,700
1101-0704-02	0307CP-W	CP SPLIT 25x25 BP	25x25 mm	Bianco	-	20	8000	0,990
1101-0705-02	0407CP-W	CP SPLIT 35x30 BP	35x30 mm	Bianco	-	20	4800	1,700

### AI SPLIT

Raccordo angolo interno 90° in scatola



Cod. europeo	Cod. fabbrica	Tipo	Descrizione	Colore	Conf. (pz)	Imballo (pz)	Pallet (pz)	€/pz
1101-0504-01	0305AI	AI SPLIT 25x25 A	25x25 mm	Avorio	-	20	8000	0,990
1101-0505-01	0405AI	AI SPLIT 35x30 A	35x30 mm	Avorio	-	20	4800	1,700
1101-0504-02	0305AI-W	AI SPLIT 25x25 BP	25x25 mm	Bianco	-	20	8000	0,990
1101-0505-02	0405AI-W	AI SPLIT 35x30 BP	35x30 mm	Bianco	-	20	4800	1,700

### AE SPLIT

Raccordo angolo esterno 90° in scatola



Cod. europeo	Cod. fabbrica	Tipo	Descrizione	Colore	Conf. (pz)	Imballo (pz)	Pallet (pz)	€/pz
1101-0604-01	0306AE	CANALSPLIT 25x25 A	25x25 mm	Avorio	-	20	8000	0,990
1101-0605-01	0406AE	CANALSPLIT 35x30 A	35x30 mm	Avorio	-	20	4800	1,700
1101-0604-02	0306AE-W	CANALSPLIT 25x25 BP	25x25 mm	Bianco	-	20	8000	0,990
1101-0605-02	0406AE-W	CANALSPLIT 35x30 BP	35x30 mm	Bianco	-	20	4800	1,700

### TT SPLIT

Tappo di chiusura terminale in scatola



Cod. europeo	Cod. fabbrica	Tipo	Descrizione	Colore	Conf. (pz)	Imballo (pz)	Pallet (pz)	€/pz
1101-0804-01	0308TT	CANALSPLIT 25x25 A	25x25 mm	Avorio	-	20	8000	0,990
1101-0905-01	0408TT	CANALSPLIT 35x30 A	35x30 mm	Avorio	-	20	8000	1,700
1101-0804-02	0308TT-W	CANALSPLIT 25x25 BP	25x25 mm	Bianco	-	20	8000	0,990
1101-0905-02	0408TT-W	CANALSPLIT 35x30 BP	35x30 mm	Bianco	-	20	8000	1,700

### GC SPLIT

Giunto coperchio in scatola



Cod. europeo	Cod. fabbrica	Tipo	Descrizione	Colore	Conf. (pz)	Imballo (pz)	Pallet (pz)	€/pz
1101-0404-01	0304GC	CANALSPLIT 25x25 A	25x25 mm	Avorio	-	20	8000	0,990
1101-0405-01	0404GC	CANALSPLIT 35x30 A	35x30 mm	Avorio	-	20	8000	1,700
1101-0404-02	0304GC-W	CANALSPLIT 25x25 BP	25x25 mm	Bianco	-	20	8000	0,990
1101-0405-02	0404GC-W	CANALSPLIT 35x30 BP	35x30 mm	Bianco	-	20	8000	1,700

## RA SPLIT

Raccordo canalina  
in scatola



Cod. europeo	Cod. fabbrica	Tipo	Descrizione	Colore	Conf. (pz)	Imballo (pz)	Pallet (pz)	€/pz
1101-2604-01	0310RC	RA SPLIT 25x25 A	25x25 mm	Avorio	-	20	8000	0,990
1101-2604-02	0310RC-W	RA SPLIT 35x30 A	35x30 mm	Avorio	-	20	8000	1,700
1101-2605-01	0410RC	RA SPLIT 25x25 BP	25x25 mm	Bianco	-	20	8000	0,990
1101-2605-02	0410RC-W	RA SPLIT 35x30 BP	35x30 mm	Bianco	-	20	8000	1,700

**SIMPLIFY  
YOUR  
WORK** 

# CANAL ICE® E CANAL DRY®

## CANALINE E ACCESSORI

### CANAL ICE®

Canalina BIANCO PURO con coperchio superiore barre da 2m in scatola



Cod. europeo	Cod. fabbrica	Tipo	Descrizione	Colore	Conf. (m)	Imballo (m)	Pallet (m)	€/m
1102-0105-01	9810-001-08	CANAL ICE 35X30 B	35x30x2000 mm	Bianco	2	64	2688	3,280
1102-0107-01	9801-001-08	CANAL ICE 65x50 B	65x50x2000 mm	Bianco	2	24	1008	5,090
1102-0108-01	9807-001-08	CANAL ICE 70x55 B	70x55x2000 mm	Bianco	2	24	1008	5,470
1102-0111-01	9806-001-08	CANAL ICE 80x60 B	80x60x2000 mm	Bianco	2	16	560	6,320
1102-0112-01	9802-001-08	CANAL ICE 90x65 B	90x65x2000 mm	Bianco	2	16	560	7,450
1102-0115-01	9803-001-08	CANAL ICE 125x75 B	125x75x2000 mm	Bianco	2	8	336	12,060

### CANAL ICE®

Canalina BIANCO PURO con coperchio superiore e film barre da 2m in scatola

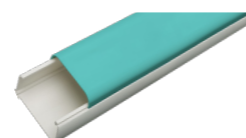

Cod. europeo	Cod. fabbrica	Tipo	Descrizione	Colore	Conf. (m)	Imballo (m)	Pallet (m)	€/m
1102-0105-02	9810-001-08F	CANAL ICE 35X30 BF	35x30x2000 mm	Bianco	2	64	2688	3,430
1102-0107-02	9801-001-08F	CANAL ICE 65x50 BF	65x50x2000 mm	Bianco	2	24	1008	5,600
1102-0108-02	9807-001-08F	CANAL ICE 70x55 BF	70x55x2000 mm	Bianco	2	24	1008	6,010
1102-0111-02	9806-001-08F	CANAL ICE 80x60 BF	80x60x2000 mm	Bianco	2	16	560	6,960
1102-0112-02	9802-001-08F	CANAL ICE 90x65 BF	90x65x2000 mm	Bianco	2	16	560	8,200
1102-0115-02	9803-001-08F	CANAL ICE 125x75 BF	125x75x2000 mm	Bianco	2	8	336	13,270



### CANAL DRY®

Canalina BIANCO PURO con coperchio avvolgente barre da 2m in scatola

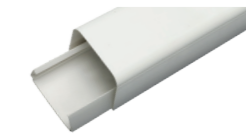

Cod. europeo	Cod. fabbrica	Tipo	Descrizione	Colore	Conf. (m)	Imballo (m)	Pallet (m)	€/m
1106-0107-01	9820-001-08	CANAL DRY 65x50 B	65x50x2000 mm	Bianco	2	24	1008	5,260
1106-0108-01	9870-001-08	CANAL DRY 70x55 B	70x55x2000 mm	Bianco	2	24	1008	5,550
1106-0111-01	9860-001-08	CANAL DRY 80x60 B	80x60x2000 mm	Bianco	2	16	560	6,530
1106-0112-01	9830-001-08	CANAL DRY 90x65 B	90x65x2000 mm	Bianco	2	16	560	7,690
1106-0115-01	9840-001-08	CANAL DRY 125x75 B	125x75x2000 mm	Bianco	2	8	336	12,450

### CANAL DRY®

Canalina BIANCO PURO con coperchio avvolgente e film barre da 2m in scatola

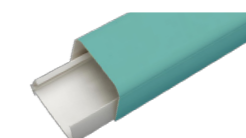

Cod. europeo	Cod. fabbrica	Tipo	Descrizione	Colore	Conf. (m)	Imballo (m)	Pallet (m)	€/m
1106-0107-02	9820-001-08F	CANAL DRY 65x50 BF	65x50x2000 mm	Bianco	2	24	1008	5,520
1106-0108-02	9870-001-08F	CANAL DRY 70x55 BF	70x55x2000 mm	Bianco	2	24	1008	5,830
1106-0111-02	9860-001-08F	CANAL DRY 80x60 BF	80x60x2000 mm	Bianco	2	16	560	7,070
1106-0112-02	9830-001-08F	CANAL DRY 90x65 BF	90x65x2000 mm	Bianco	2	16	560	8,070
1106-0115-02	9840-001-08F	CANAL DRY 125x75 BF	125x75x2000 mm	Bianco	2	8	336	13,070



## SB ICE/DRY

Supporto di bloccaggio  
in scatola



Cod. europeo	Cod. fabbrica	Tipo	Descrizione	Colore	Conf. (pz)	Imballo (pz)	Pallet (pz)	€/pz
1102-0307-01	9801-101-00	SB ICE/DRY 65x50	65x50 mm	Giallo	1	25	5000	0,450
1102-0308-01	9807-101-00	SB ICE/DRY 70x55	70x55 mm	Giallo	1	25	6250	0,460
1102-0311-01	9806-101-00	SB ICE/DRY 80x60	80x60 mm	Giallo	1	25	5000	0,470
1102-0312-01	9802-101-00	SB ICE/DRY 90x65	90x65 mm	Giallo	1	25	6250	0,510
1102-0315-01	9803-101-00	SB ICE/DRY 125x75	125x75 mm	Giallo	1	25	6250	0,620

## GC ICE/DRY

Giunto coperchio  
in scatola



Cod. europeo	Cod. fabbrica	Tipo	Descrizione	Colore	Conf. (pz)	Imballo (pz)	Pallet (pz)	€/pz
1102-0405-01	9810-102-08	GC ICE/DRY 35x30 B	35x30 mm	Bianco	1	25	3200	2,640
1102-0407-01	9801-102-08	GC ICE/DRY 65x50 B	65x50 mm	Bianco	1	25	6250	1,760
1102-0408-01	9807-102-08	GC ICE/DRY 70x55 B	70x55 mm	Bianco	1	25	6250	2,000
1102-0411-01	9806-102-08	GC ICE/DRY 80x60 B	80x60 mm	Bianco	1	25	1600	2,130
1102-0412-01	9802-102-08	GC ICE/DRY 90x65 B	90x65 mm	Bianco	1	25	4000	2,270
1102-0415-01	9803-102-08	GC ICE/DRY 125x75 B	125x75 mm	Bianco	1	25	4000	2,620

## AI ICE/DRY

Raccordo angolo interno 90°  
in scatola

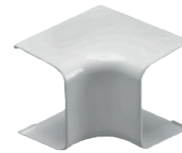

Cod. europeo	Cod. fabbrica	Tipo	Descrizione	Colore	Conf. (pz)	Imballo (pz)	Pallet (pz)	€/pz
1102-0505-01	9810-112-08	AI ICE/DRY 35x30 B	35x30 mm	Bianco	1	20	3200	2,640
1102-0507-01	9801-112-08	AI ICE/DRY 65x50 B	65x50 mm	Bianco	1	10	1600	3,400
1102-0508-01	9807-112-08	AI ICE/DRY 70x55 B	70x55 mm	Bianco	1	10	1600	3,450
1102-0511-01	9806-112-08	AI ICE/DRY 80x60 B	80x60 mm	Bianco	1	10	1600	3,570
1102-0512-01	9802-112-08	AI ICE/DRY 90x65 B	90x65 mm	Bianco	1	10	1600	3,790
1102-0515-01	9803-112-08	AI ICE/DRY 125x75 B	125x75 mm	Bianco	1	10	440	4,850

## AE ICE/DRY

Raccordo angolo esterno 90°  
in scatola



Cod. europeo	Cod. fabbrica	Tipo	Descrizione	Colore	Conf. (pz)	Imballo (pz)	Pallet (pz)	€/pz
1102-0605-01	9810-113-08	AE ICE/DRY 35x30 B	35x30 mm	Bianco	1	20	3200	2,640
1102-0607-01	9801-113-08	AE ICE/DRY 65x50 B	65x50 mm	Bianco	1	10	1600	3,400
1102-0608-01	9807-113-08	AE ICE/DRY 70x55 B	70x55 mm	Bianco	1	10	1600	3,450
1102-0611-01	9806-113-08	AE ICE/DRY 80x60 B	80x60 mm	Bianco	1	10	1600	3,570
1102-0612-01	9802-113-08	AE ICE/DRY 90x65 B	90x65 mm	Bianco	1	10	1600	3,790
1102-0615-01	9803-113-08	AE ICE/DRY 125x75 B	125x75 mm	Bianco	1	10	440	4,850

## CP ICE/DRY

Curva piana 90°  
in scatola

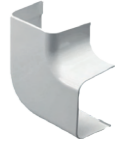

Cod. europeo	Cod. fabbrica	Tipo	Descrizione	Colore	Conf. (pz)	Imballo (pz)	Pallet (pz)	€/pz
1102-0705-01	9810-115-08	CP ICE/DRY 35x30 B	35x30 mm	Bianco	1	20	3200	2,640
1102-0707-01	9801-115-08	CP ICE/DRY 65x50 B	65x50 mm	Bianco	1	10	1600	3,910
1102-0708-01	9807-115-08	CP ICE/DRY 70x55 B	70x55 mm	Bianco	1	10	1600	4,600
1102-0711-01	9806-115-08	CP ICE/DRY 80x60 B	80x60 mm	Bianco	1	10	1600	4,930
1102-0712-01	9802-115-08	CP ICE/DRY 90x65 B	90x65 mm	Bianco	1	10	780	5,230
1102-0715-01	9803-115-08	CP ICE/DRY 125x75 B	125x75 mm	Bianco	1	10	440	6,950

## TT ICE/DRY

Tappo di chiusura terminale  
in scatola



Cod. europeo	Cod. fabbrica	Tipo	Descrizione	Colore	Conf. (pz)	Imballo (pz)	Pallet (pz)	€/pz
1102-0805-01	9810-114-08	TT ICE/DRY 35x30 B	35x30 mm	Bianco	1	20	3200	2,640
1102-0807-01	9801-114-08	TT ICE/DRY 65x50 B	65x50 mm	Bianco	1	10	1600	3,300
1102-0808-01	9807-114-08	TT ICE/DRY 70x55 B	70x55 mm	Bianco	1	10	1600	3,350
1102-0811-01	9806-114-08	TT ICE/DRY 80x60 B	80x60 mm	Bianco	1	10	1600	3,460
1102-0812-01	9802-114-08	TT ICE/DRY 90x65 B	90x65 mm	Bianco	1	10	1600	3,580
1102-0815-01	9803-114-08	TT ICE/DRY 125x75 B	125x75 mm	Bianco	1	10	440	4,890

## CM ICE/DRY

Curva terminale a muro  
in scatola



Cod. europeo	Cod. fabbrica	Tipo	Descrizione	Colore	Conf. (pz)	Imballo (pz)	Pallet (pz)	€/pz
1102-0905-01	9810-116-08	CM ICE/DRY 35x30 B	35x30 mm	Bianco	1	20	3200	2,640
1102-0907-01	9801-116-08	CM ICE/DRY 65x50 B	65x50 mm	Bianco	1	10	1600	4,350
1102-0908-01	9807-116-08	CM ICE/DRY 70x55 B	70x55 mm	Bianco	1	10	1600	4,750
1102-0911-01	9806-116-08	CM ICE/DRY 80x60 B	80x60 mm	Bianco	1	10	1600	4,920
1102-0912-01	9802-116-08	CM ICE/DRY 90x65 B	90x65 mm	Bianco	1	10	780	5,230
1102-0915-01	9803-116-08	CM ICE/DRY 125x75 B	125x75 mm	Bianco	1	10	440	6,580

## PM ICE/DRY

Passaggio a muro  
in scatola



Cod. europeo	Cod. fabbrica	Tipo	Descrizione	Colore	Conf. (pz)	Imballo (pz)	Pallet (pz)	€/pz
1102-1005-01	9810-111-08	PM ICE/DRY 35x30 B	35x30 mm	Bianco	1	20	3200	2,640
1102-1007-01	9801-111-08	PM ICE/DRY 65x50 B	65x50 mm	Bianco	1	10	1600	3,250
1102-1008-01	9807-111-08	PM ICE/DRY 70x55 B	70x55 mm	Bianco	1	10	1600	3,430
1102-1011-01	9806-111-08	PM ICE/DRY 80x60 B	80x60 mm	Bianco	1	10	1600	3,780
1102-1012-01	9802-111-08	PM ICE/DRY 90x65 B	90x65 mm	Bianco	1	10	1600	4,020
1102-1015-01	9803-111-08	PM ICE/DRY 125x75 B	125x75 mm	Bianco	1	10	1600	5,430

## GF ICE/DRY

Giunto flessibile  
in scatola

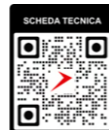

Cod. europeo	Cod. fabbrica	Tipo	Descrizione	Colore	Conf. (pz)	Imballo (pz)	Pallet (pz)	€/pz
1102-1107-01	9801-202-08	PM ICE/DRY 65x50 B	65x50 mm	Bianco	1	6	300	9,430
1102-1108-01	9807-202-08	PM ICE/DRY 70x55 B	70x55 mm	Bianco	1	6	300	9,950
1102-1111-01	9806-202-08	PM ICE/DRY 80x60 B	80x60 mm	Bianco	1	6	480	10,810
1102-1112-01	9802-202-08	PM ICE/DRY 90x65 B	90x65 mm	Bianco	1	6	300	11,890
1102-1115-01	9803-202-08	PM ICE/DRY 125x75 B	125x75 mm	Bianco	1	6	150	15,450

## T ICE/DRY

Derivazione a T  
in scatola

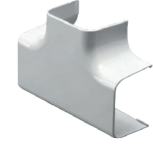

Cod. europeo	Cod. fabbrica	Tipo	Descrizione	Colore	Conf. (pz)	Imballo (pz)	Pallet (pz)	€/pz
1102-1307-01	9801-200-08	T ICE/DRY 65x50 B	65x50 mm	Bianco	1	6	264	5,950
1102-1311-01	9806-200-08	T ICE/DRY 80x60 B	80x60 mm	Bianco	1	6	960	7,440
1102-1312-01	9802-200-08	T ICE/DRY 90x65 B	90x65 mm	Bianco	1	6	780	8,040
1102-1315-01	9803-200-08	T ICE/DRY 125x75 B	125x75 mm	Bianco	1	6	264	9,300

## RI ICE/DRY

Riduzione  
in scatola



Cod. europeo	Cod. fabbrica	Tipo	Descrizione	Colore	Conf. (pz)	Imballo (pz)	Pallet (pz)	€/pz
1102-1400-01	9806-201-08	RI ICE/DRY 80-60 B	80-60 mm	Bianco	1	10	1600	2,840
1102-1400-02	9808-201-08	RI ICE/DRY 80-65 B	80-65 mm	Bianco	1	10	1600	2,950
1102-1400-03	9807-201-08	RI ICE/DRY 80-70 B	80-70 mm	Bianco	1	10	1600	3,000
1102-1412-01	9802-201-08	RI ICE/DRY 90-65 B	90-65 mm	Bianco	1	10	1600	3,030
1102-1420-01	9804-201-08	RI ICE/DRY 90-70 B	90-70 mm	Bianco	1	10	1600	3,100
1102-1415-02	9805-201-08	RI ICE/DRY 125-80 B	125-80 mm	Bianco	1	10	780	4,050
1102-1415-01	9803-201-08	RI ICE/DRY 125-90 B	125-90 mm	Bianco	1	10	780	4,050

## CR ICE/DRY

Curva piana regolabile  
in scatola



Cod. europeo	Cod. fabbrica	Tipo	Descrizione	Colore	Conf. (pz)	Imballo (pz)	Pallet (pz)	€/pz
1102-2307-01	9801-117-08	CR ICE/DRY 65x50 B	65x50 mm	Bianco	1	6	468	4,820
1102-2308-01	9807-117-08	CR ICE/DRY 70x55 B	70x55 mm	Bianco	1	6	234	5,900
1102-2311-01	9806-117-08	CR ICE/DRY 80x60 B	80x60 mm	Bianco	1	6	780	6,060
1102-2312-01	9802-117-08	CR ICE/DRY 90x65 B	90x65 mm	Bianco	1	6	468	7,210
1102-2315-01	9802-117-08	CR ICE/DRY 125x75 B	125x75 mm	Bianco	1	6	352	10,100

# 10. STAFFE ED ACCESSORI PER UNITÀ ESTERNE

Le staffe Rodigas® sono progettate per soddisfare le richieste di un mercato in rapida crescita, fornendo una soluzione affidabile e visivamente accattivante per l'installazione di unità esterne di climatizzazione e pompe di calore.

Realizzate con materiali di alta qualità per una resistenza eccezionale, garantiscono un supporto sicuro e di lunga durata.

I nostri prodotti sono progettati con una forte attenzione sia all'affidabilità sia alla facilità di installazione.

SCOPRI DI PIÙ,  
INQUADRA IL  
QR CODE



## Certificazioni di produzione



## Test del prodotto e assicurazione



## Certificazioni di prodotto solo dove indicato



## Certificazioni dei prodotti

I prodotti e i processi certificati sono la migliore garanzia di qualità che possiamo offrire. È per questo motivo che ci confrontiamo continuamente con istituzioni e professionisti accreditati che ci guidano nel nostro viaggio.

Il nostro team di gestione della qualità esegue ispezioni e test rigorosi durante tutto il processo di produzione.

## Processo di verniciatura

Le mensole, realizzate principalmente in acciaio elettrozincato, sono verniciate a polvere con vernici a base di resina epossidica, che aderiscono per effetto elettrostatico, per poi passare attraverso un forno dove, grazie alle elevate temperature, la vernice prima si scioglie e poi si polimerizza, creando uno strato protettivo aderente che rende i nostri prodotti adatti per applicazioni all'aperto, con oltre 480 ore di resistenza ai test di nebbia salina.

## Caratteristiche e vantaggi del prodotto

### Assicurazione

I nostri prodotti sono coperti da assicurazione di responsabilità civile per eventuali danni causati da difetti di fabbricazione.

### Capacità di carico

I prodotti certificati TÜV sono in grado di sopportare tre volte il peso dichiarato.

### Processo di saldatura

Data l'importanza di questo processo in tutti i nostri settori produttivi, il nostro team è composto da saldatori certificati. Aderendo agli appropriati protocolli certificati, siamo in grado di eseguire saldature su acciaio decapato, acciaio inossidabile e alluminio.

Rodigas®  
BAL

niccons®  
HVAC MANUFACTURING

WALY EVERY WALL  
NEEDS AN ALLY

## WALLY

Coppia di mensole regolabili universali in lamiera zincata e verniciata a polveri epossidiche, in scatola



Cod. europeo	Cod. fabbrica	Dimensioni	Carico MAX	Colore	Viti	Imballo (pz)	Pallet (pz)	€/pz
1221-0202-01	MS 742 304	420x800x375 mm	50+50 kg	RAL 9002	1xM6	1	117	25,780
1221-0204-01	MS 765 304	465x800x375 mm	50+50 kg	RAL 9002	1xM6	1	117	28,050

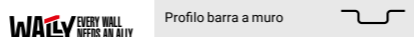

## STAFFA CLIMA REGOLABILE

Coppia di mensole scorrevoli regolabili Rodigas® certificate TÜV Süd complete di accessori, in scatola



Cod. europeo	Cod. fabbrica	Dimensioni	Carico MAX	Colore	Viti	Imballo (pz)	Pallet (pz)	€/pz
1203-0702-01*	MS 230 206	420x800x375 mm	140 kg	RAL 9002	1xM6	1	117	29,180
1203-0202-01	MS 230 106	420x800x375 mm	140 kg	RAL 9002	1xM6	1	117	30,650
1203-0204-06	MS 253 105	465x800x375 mm	140 kg	RAL 9002	1xM6	1	117	36,960
1203-0208-04	MS 257 105	550x800x375 mm	140 kg	RAL 9002	1xM6	1	117	43,140
1203-0212-02	MS 258 105	650x800x420 mm	140 kg	RAL 9002	2xM6	1	108	57,830
1203-0204-04	MS 253N 105	465x800x375 mm	140 kg	RAL 7016	1xM6	1	117	40,890
1203-0208-03	MS 257N 105	550x800x375 mm	140 kg	RAL 7016	1xM6	1	117	47,080
1203-0212-03	MS 258N 105	650x800x420 mm	140 kg	RAL 7016	2xM6	1	108	62,780

\* non premontata

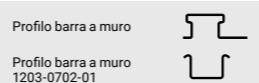

## STAFFA CLIMA REGOLABILE ACCIAIO INOX

Coppia di mensole scorrevoli Rodigas® in acciaio inossidabile complete di accessori, in scatola



Cod. europeo	Cod. fabbrica	Dimensioni	Carico MAX	Colore	Viti	Imballo (pz)	Pallet (pz)	€/pz
1203-0204-05	MS 263 111	465x800x375 mm	140 kg	RAL 7035	1xM6	1	117	98,040
1203-0208-05	MS 264 111	550x800x375 mm	140 kg	RAL 7035	1xM6	1	117	102,320

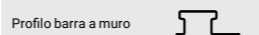

## STAFFA CLIMA REGOLABILE EXTRA LOAD

Coppia di mensole scorrevoli Rodigas® per carichi pesanti\*\* con fissaggi a muro e livella, in scatola



Cod. europeo	Cod. fabbrica	Dimensioni	Carico MAX	Colore	Viti	Imballo (pz)	Pallet (pz)	€/pz
1208-0408-01	MS 291 133	550x1160x500 mm	250 kg	RAL 9002	2xM8	1	108	88,010
1208-0413-01	MS 293 133	700x1160x500 mm	250 kg	RAL 9002	2xM8	1	108	102,000
1208-0414-01	MS 295 133	800x1160x500 mm	200 kg	RAL 9002	2xM8	1	108	117,310
1208-0915-02*	MS 297 233	1000x1160x500 mm	200 kg	RAL 9002	2xM8	1	108	141,020
1208-0408-02	MS 291 N133	550x1160x500 mm	250 kg	RAL 7016	2xM8	1	108	93,290
1208-0413-02	MS 293 N133	700x1160x500 mm	250 kg	RAL 7016	2xM8	1	108	107,260
1208-0414-02	MS 295 N133	800x1160x500 mm	200 kg	RAL 7016	2xM8	1	108	125,010
1208-0915-01*	MS 297 N233	1000x1160x500 mm	200 kg	RAL 7016	2xM8	1	108	150,390

\* non premontata

\*\*Gli antivibranti sono disponibili come optional e vanno scelti in base al peso e alle dimensioni dell'unità esterna, ulteriori informazioni su rodigas.it

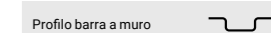

## STAFFA CLIMA AGGANCIAMENTO FRONTALE

Coppia di mensole scorrevoli Rodigas® ad aggancio frontale certificate TÜV Süd, in scatola



Cod. europeo	Cod. fabbrica	Dimensioni	Carico MAX	Colore	Viti	Imballo (pz)	Pallet (pz)	€/pz
1205-0204-02	MS 220 105	465x800x375 mm	140 kg	RAL 9002	1xM6	1	117	50,010
1205-0308-01	MS 223 105	550x1000x375 mm	140 kg	RAL 9002	1xM6	1	108	53,330

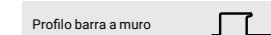

## STAFFA CLIMA REGOLABILE TRE BRACCI

Coppia di mensole scorrevoli Rodigas® a tre bracci per carichi pesanti\*\* in scatola



Cod. europeo	Cod. fabbrica	Dimensioni	Carico MAX	Colore	Viti	Imballo (pz)	Pallet (pz)	€/pz
1212-0408-01	MS 215 133	550x1160x500 mm	250 kg	RAL 9002	2xM8	-	54	117,930
1212-0413-02	MS 216 133	700x1160x500 mm	250 kg	RAL 9002	2xM8	-	54	138,040
1212-0414-01	MS 217 133	800x1160x500 mm	200 kg	RAL 9002	2xM8	-	54	178,500
1212-0915-01*	MS 218 233	1000x1160x500 mm	200 kg	RAL 9002	2xM8	-	54	208,000
1212-0408-02	MS 215 N133	550x1160x500 mm	250 kg	RAL 7016	2xM8	-	54	125,130
1212-0413-01	MS 216 N133	700x1160x500 mm	250 kg	RAL 7016	2xM8	-	54	146,170
1212-0414-02	MS 217 N133	800x1160x500 mm	200 kg	RAL 7016	2xM8	-	54	172,860
1212-0915-02*	MS 218 N233	1000x1160x500 mm	200 kg	RAL 7016	2xM8	-	54	214,700

\* non premontata

\*\*Gli antivibranti sono disponibili come optional e vanno scelti in base al peso e alle dimensioni dell'unità esterna, ulteriori informazioni su rodigas.it

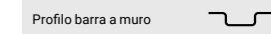

## ATENA

Mensole regolabili universali in acciaio zincato con verniciatura a polveri epossidiche in scatola



Cod. europeo	Cod. fabbrica	Dimensioni	Carico MAX	Colore	Viti	Imballo (pz)	Pallet (pz)	€/pz
1214-1102-01	9793-420-121	420x800x375 mm	140 kg	RAL 9002	1xM6	1	117	35,250
1214-1103-01	9793-450-151	450x800x375 mm	160 kg	RAL 9002	1xM6	1	117	40,550
1214-1103-02	9793-450-121	450x800x375 mm	140 kg	RAL 9002	1xM6	1	117	36,490
1214-1105-01	9793-480-151	480x800x375 mm	140 kg	RAL 9002	1xM6	1	117	43,250
1214-1107-01	9793-540-202	540x800x375 mm	200 kg	RAL 9002	1xM6	1	117	49,200
1214-1111-01	9793-600-202	600x800x375 mm	200 kg	RAL 9002	2xM6	1	117	53,570

Profilo barra a muro

## ATENA VX

Mensole regolabili universali in acciaio zincato con viteria inox a polveri epossidiche in scatola



Cod. europeo	Cod. fabbrica	Dimensioni	Carico MAX	Colore	Viti	Imballo (pz)	Pallet (pz)	€/pz
1214-1102-09	9793-420-121 IX	420x800x400 mm	140 kg	RAL 9002	1xM6	1	117	41,240
1214-1103-09	9793-450-151 IX	450x800x400 mm	140 kg	RAL 9002	1xM6	1	117	45,600
1214-1105-09	9793-480-151 IX	480x800x400 mm	140 kg	RAL 9002	1xM6	1	117	48,500

Profilo barra a muro

## RODI

Mensole regolabili premontate con antivibranti professionali alti in scatola



Cod. europeo	Cod. fabbrica	Dimensioni	Carico MAX	Colore	Viti	Imballo (pz)	Pallet (pz)	€/pz
1203-0202-02	MS255 107	420x800x375 mm	140 kg	RAL 9002	1xM6	1	117	40,640
1203-0204-02	MS253 107	465x800x375 mm	140 kg	RAL 9002	1xM6	1	117	53,290
1203-0208-01	MS257 107	550x800x375 mm	140 kg	RAL 9002	1xM6	1	117	75,240
1203-0212-01	MS258 107	650x800x420 mm	140 kg	RAL 9002	2xM6	1	108	86,030

Profilo barra a muro

## STAFFE CLIMA SALDATE E VERNICIATE

Mensole saldate Rodigas® standard\*\*, realizzate in acciaio decapato e rivestite con vernice a base di resina epossidica in polvere



Cod. europeo	Cod. fabbrica	Dimensioni	Carico MAX	Colore	Larg. bracci	Imballo (pz)	Pallet (pz)	€/pz
1202-0002-01	MS 105	420x315 mm	140 kg	RAL 9002	40 mm	20	200	20,140
1202-0006-01	MS 106	520x420 mm	140 kg	RAL 9002	50 mm	12	168	25,460
1202-0006-02	MS 116	665x420 mm	160 kg	RAL 9002	50 mm	5	90	34,000

\*\*Gli antivibranti sono disponibili come optional e vanno scelti in base al peso e alle dimensioni dell'unità esterna, ulteriori informazioni su rodigas.it

## STAFFE CLIMA SALDATE ZINCATE A CALDO

Mensole saldate Rodigas® standard\*\*, realizzate in acciaio zincato a caldo con finitura naturale



Cod. europeo	Cod. fabbrica	Dimensioni	Carico MAX	Colore	Larg. bracci	Imballo (pz)	Pallet (pz)	€/pz
1202-0002-04	MS 105 102	420x315 mm	140 kg	Acciaio	40 mm	20	200	32,120
1202-0006-04	MS 106 110	520x420 mm	140 kg	Acciaio	50 mm	12	168	43,710
1202-0009-02	MS 116 107	665x420 mm	160 kg	Acciaio	50 mm	5	90	62,830

\*\*Gli antivibranti sono disponibili come optional e vanno scelti in base al peso e alle dimensioni dell'unità esterna, ulteriori informazioni su rodigas.it

## STAFFE CLIMA SALDATE ELETTROZINCATE VERNICIATE

Mensole saldate Rodigas® standard\*\*, realizzate in acciaio decapato e successivamente elettrozincate e rivestite con vernice a polvere a base di resina epossidica



Cod. europeo	Cod. fabbrica	Dimensioni	Carico MAX	Colore	Larg. bracci	Imballo (pz)	Pallet (pz)	€/pz
1202-0002-03	MS 105 302	420x315 mm	140 kg	RAL 9002	40 mm	20	200	25,140
1202-0006-03	MS 106 303	520x420 mm	140 kg	RAL 9002	50 mm	12	168	32,740
1202-0009-01	MS 116 304	665x420 mm	160 kg	RAL 9002	50 mm	5	90	41,910

\*\*Gli antivibranti sono disponibili come optional e vanno scelti in base al peso e alle dimensioni dell'unità esterna, ulteriori informazioni su rodigas.it

## STAFFE CLIMA SALDATE HEAVY LOAD

Coppia di mensole saldate Rodigas®\*\* ad alta portata realizzate in acciaio elettrozincato e verniciate a polvere a base di resina epossidica, in scatola



Cod. europeo	Cod. fabbrica	Dimensioni	Carico MAX	Colore	Larg. bracci	Imballo (pz)	Pallet (pz)	€/pz
1202-1306-01	MS 402	520x400 mm	300 kg	RAL 9002	60 mm	5	70	45,730
1202-1309-01	MS 403	620x400 mm	240 kg	RAL 9002	60 mm	5	70	52,880
1202-1313-01	MS 406	700x400 mm	180 kg	RAL 9002	60 mm	1	45	77,960
1202-1314-01	MS 404	800x520 mm	180 kg	RAL 9002	60 mm	1	30	81,960
1202-1316-01	MS 405	1100x500 mm	100 kg	RAL 9002	60 mm	1	13	147,600

\*\*Gli antivibranti sono disponibili come optional e vanno scelti in base al peso e alle dimensioni dell'unità esterna, ulteriori informazioni su rodigas.it

## STAFFE CLIMA SALDATE INDUSTRIAL LOAD

Coppia di mensole saldate Rodigas®\*\*, realizzate in acciaio elettrozincato e rivestite con vernice a polvere a base di resina epossidica, in scatola



Cod. europeo	Cod. fabbrica	Dimensioni	Carico MAX	Colore	Larg. bracci	Imballo (pz)	Pallet (pz)	€/pz
1202-1406-01	MS 502	520x400 mm	360 kg	RAL 9002	80 mm	5	60	84,880
1202-1409-01	MS 503	620x400 mm	300 kg	RAL 9002	80 mm	5	60	90,390
1202-1414-01	MS 504	800x500 mm	220 kg	RAL 9002	80 mm	1	24	120,600
1202-1416-01	MS 505	1100x550 mm	160 kg	RAL 9002	80 mm	1	10	187,760

\*\*Gli antivibranti sono disponibili come optional e vanno scelti in base al peso e alle dimensioni dell'unità esterna, ulteriori informazioni su rodigas.it

## STAFFE CLIMA SALDATE EXTRA LOAD

Mensole saldate Rodigas®\*\*, realizzate in acciaio elettrozincato e rivestite con vernice a polvere a base di resina epossidica, in scatola



Cod. europeo	Cod. fabbrica	Dimensioni	Carico MAX	Colore	Larg. bracci	Imballo (pz)	Pallet (pz)	€/pz
1202-1515-01	MS 801	1000x700 mm	300 kg	RAL 9002	135 mm	1	10	502,590
1202-1518-01	MS 802	1200x750 mm	300 kg	RAL 9002	135 mm	1	5	576,560
1202-1517-01	MS 803	1400x800 mm	400 kg	RAL 9002	135 mm	1	10	682,480
1202-1519-01	MS 804	1600x830 mm	500 kg	RAL 9002	135 mm	1	5	895,610

\*\*Gli antivibranti sono disponibili come optional e vanno scelti in base al peso e alle dimensioni dell'unità esterna, ulteriori informazioni su rodigas.it

## STAFFE CLIMA PIEGHEVOLI

Coppia di mensole pieghevoli Rodigas®\*\* complete di accessori, in scatola



Cod. europeo	Cod. fabbrica	Dimensioni	Carico MAX	Colore	Viti	Imballo (pz)	Pallet (pz)	€/pz
1201-1202-01	MS 120 206	420x375 mm	140 kg	RAL 9002	1xM6	1	170	24,580
1201-0004-01	MS 117 105	465x375 mm	140 kg	RAL 9002	1xM6	1	170	30,040
1201-0008-01	MS 118 105	550x375 mm	140 kg	RAL 9002	1xM6	1	170	36,280
1201-0012-01	MS 121 105	650x420 mm	140 kg	RAL 9002	2xM6	1	117	41,720

## STAFFE CLIMA PIEGHEVOLI EXTRA LOAD

Coppia di mensole pieghevoli Rodigas®\*\* Extra Load complete di accessori, in scatola



Cod. europeo	Cod. fabbrica	Dimensioni	Carico MAX	Colore	Viti	Imballo (pz)	Pallet (pz)	€/pz
1209-0008-01	MS 119 105	550x500 mm	200 kg	RAL 9002	2xM8	1	117	48,880
1209-0013-01	MS 122 133	700x500 mm	200 kg	RAL 9002	2xM8	1	117	58,660

## STAFFE CLIMA SALDATE IN ACCIAIO INOX

Coppia di mensole saldate Rodigas® realizzate in acciaio inossidabile e rivestite con vernice a polvere a base di resina epossidica, in scatola



Cod. europeo	Cod. fabbrica	Dimensioni	Carico MAX	Colore	Larg. bracci	Imballo (pz)	Pallet (pz)	€/pz
1202-0002-02	MS 112*	420x315 mm	140 kg	RAL 9002	40 mm	10	200	60,420
1202-0002-05	MS 111	420x315 mm	140 kg	RAL 7035	40 mm	10	200	60,720
1202-0006-06	MS 150	520x420 mm	140 kg	RAL 7035	50 mm	5	70	102,360
1202-0009-03	MS 151	620x420 mm	140 kg	RAL 7035	50 mm	5	90	117,480
1202-0014-01	MS 153	800x500 mm	220 kg	RAL 7035	80 mm	1	24	206,040

\*Verniciata

## STAFFA CLIMA DA SOFFITTO

Coppia di mensole Rodigas®\*\*, saldate speciali specifiche per installazioni a soffitto di unità esterne, in scatola



Cod. europeo	Cod. fabbrica	Dimensioni	Carico MAX	Colore	Imballo (pz)	Pallet (pz)	€/pz
1204-0002-01	MC 700 300	420x780 mm	140 kg	RAL 9002	1	40	97,200

\*\*Gli antivibranti sono disponibili come optional e vanno scelti in base al peso e alle dimensioni dell'unità esterna, ulteriori informazioni su rodigas.it

## STAFFE CLIMA REGOLABILI TETTO INCLINATO

Mensole Rodigas®, preassemblate e realizzate in acciaio zincato a freddo e verniciate, in scatola



Cod. europeo	Cod. fabbrica	Dimensioni	Carico MAX	Colore	Angolo	Imballo (pz)	Pallet (pz)	€/pz
1213-0202-01	MT 630 101	420x800 mm	140 kg	RAL 9002	20° - 51°	1	108	67,620
1213-0206-01	MT 650 101	520x800 mm	140 kg	RAL 9002	20° - 51°	1	108	97,050

## RODI DA TETTO CON MONTAGGIO SOTTO-TEGOLA

Mensole Rodigas®, regolabili in base a diversi angoli di inclinazione in scatola



Cod. europeo	Cod. fabbrica	Dimensioni	Carico MAX	Colore	Angolo	Imballo (pz)	Pallet (pz)	€/pz
1213-0003-01	MT 600 212	450x800 mm	140 kg	RAL 9002	0° - 45°	1	108	166,620

# ACCESSORI PER UNITÀ ESTERNE

## ISOCLIMA 12X200

Fissaggio isolante per murature con isolamento a cappotto in busta trasparente da 2 pz/cad

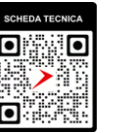

Cod. europeo	Cod. fabbrica	Tipo	Descrizione	Conf. (pz)	Imballo (pz)	Pallet (pz)	€/pz
9903-0502-25	120225	ISOCLIMA 12x200	Cappotti spessore 80-160 mm	2	10	560	48,900

## ANTI

Kit antivibranti 26/15 mm in scatola

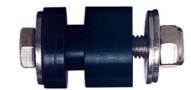

Cod. europeo	Cod. fabbrica	Descrizione	Conf. (pz)	Imballo (pz)	Pallet (pz)	€/pz
2500-0059-52	161720	Acciaio INOX	-	20	6720	8,520
2500-0059-53	161725	Acciaio zincato	-	20	6720	4,500

## ANTI CIL3

Kit antivibranti cilindrici a pavimento 40/40 mm in busta



Cod. europeo	Cod. fabbrica	Descrizione	Conf. (pz)	Imballo (conf)	Pallet (pz)	€/conf
1506-0500-03	9898-026	40/40 mm - M8	4	20	800	13,530

## ANTI CON2

Kit antivibranti conico a filettatura singola a pavimento 57/20 mm in busta



Cod. europeo	Cod. fabbrica	Descrizione	Conf. (pz)	Imballo (conf)	Pallet (pz)	€/conf
1506-0500-05	9898-014	52/57x20 mm	4	20	8000	11,350

## ANTI CON1

Kit antivibranti conici a filettatura singola a pavimento 46/20 mm in busta



Cod. europeo	Cod. fabbrica	Descrizione	Conf. (pz)	Imballo (conf)	Pallet (pz)	€/conf
1506-0500-02	9898-025	42/46x20 mm - M8	4	20	3120	10,290

## ANTI CDF4

Kit antivibranti cilindrici doppia vite 40/40 mm in busta



Cod. europeo	Cod. fabbrica	Descrizione	Conf. (pz)	Imballo (conf)	Pallet (pz)	€/conf
1506-0500-07	9898-027	40/40 mm - M8	4	20	800	18,060

## ANTI CDF1

Kit antivibranti cilindrici doppia vite 30/20 mm in busta



Cod. europeo	Cod. fabbrica	Descrizione	Conf. (pz)	Imballo (conf)	Pallet (pz)	€/conf
1506-0500-04	9898-028	30/20 mm - M8	4	20	800	12,460

## ANTI CDF 2-3-5

Kit antivibranti cilindrici a doppia vite in busta



Cod. europeo	Cod. fabbrica	Filettatura	Descrizione	Conf. (pz)	Imballo (conf)	Pallet (pz)	€/conf
1506-0531-01	0503.00001.006	2 x M8	30x30 mm	4	200	9600	13,100
1506-0038-01	AV 301	2 x M8	40x30 mm	4	25	1500	13,560
1506-0040-02	AV 401	2 x M10	50x40 mm	4	10	600	21,940

## ANTI DF 1-5

Kit antivibranti conici a doppio filetto in busta



Cod. europeo	Cod. fabbrica	Filettatura	Descrizione	Colore	Conf. (pz)	Imballo (pz)	Pallet (pz)	€/pz
1506-0500-09	9898-023	2xM8	29/38x22 mm	Grigio	4	20	3200	9,050
1506-0500-01	9898-024	2xM8	29/38x22 mm	Nero	4	20	3200	8,550
1506-0500-10	9898-024LN	2xM8	29/38x22 mm	Nero	4	20	1680	9,550
1506-0500-11	9898-024LN morbido	2xM8	32/45x22 mm	Nero	4	20	1680	10,100
1506-0500-06	9898-022	2xM8	45/30 mm	Nero	4	20	8000	13,240

## ANTI CIL 1-2

Kit antivibranti cilindrici a pavimento in busta



Cod. europeo	Cod. fabbrica	Descrizione	Conf. (pz)	Imballo (pz)	Pallet (pz)	€/pz
1506-0537-01	AV 108	30x20 mm	4	50	1850	7,090
1506-0538-01	AV 302	30x30 mm	4	25	1500	13,110

## SMUC

Sollevatore di unità esterne di climatizzazione in scatola



Cod. europeo	Cod. fabbrica	Descrizione	Conf. (pz)	Imballo (pz)	Pallet (pz)	€/pz
1750-1010-01	1750-1010-01	Portata max. 150 kg	-	1	-	430,000

# 11. SUPPORTI A PAVIMENTO

Con l'aumento delle dimensioni delle unità esterne presenti sul mercato, che vanno dai sistemi residenziali a quelli industriali su larga scala, la richiesta di supporti a pavimento ad alte prestazioni con elevata capacità di carico e un efficace assorbimento delle vibrazioni è ai massimi storici. Le nostre soluzioni di supporti a pavimento sono progettate specificamente per accogliere queste unità più grandi, garantendo una durata e stabilità superiori. Realizzati con materiali ingegneristici, garantiscono prestazioni ottimali in un'ampia gamma di applicazioni. Inoltre, il processo di installazione è semplificato, in quanto il montaggio dell'unità esterna non richiede alcuna perforazione su pareti o pavimenti, eliminando così il rischio di infiltrazione d'acqua ed evitando eventuali modifiche strutturali.

SCOPRI DI PIÙ,  
INQUADRA IL  
QR CODE



EU MADE IN  
UV RESISTANT  
RECYCLE

## Sempre il prodotto giusto

I nostri supporti a pavimento sono realizzati con una selezione di materiali ad alte prestazioni come acciaio zincato, PVC, nylon, polipropilene e varie combinazioni di questi, per garantire la massima durata ed efficienza in una vasta gamma di applicazioni.

## Caratteristiche e vantaggi del prodotto

Capacità di carico

La nostra gamma di supporti a pavimento è progettata per accogliere tutti i tipi di unità esterne, dai modelli residenziali ai sistemi industriali su larga scala.

Installazione semplice

Il processo di installazione è rapido, in quanto l'unità esterna può essere montata senza la necessità di forature a parete o a pavimento, eliminando il rischio di infiltrazioni d'acqua ed evitando eventuali alterazioni strutturali.

Rodigas

niccons  
HVAC MANUFACTURING

ARTIPLASTIC<sup>®</sup>  
SMART PLASTIC SOLUTIONS

Castel<sup>®</sup>  
engineering

## BP S 80-100

Basi a pavimento in PVC con strisce antiscivolo (coppia in scatola) in scatola



Cod. europeo	Cod. fabbrica	Tipo	Dimensioni	Colore	Conf. (pz)	Imballo (pz)	Pallet (pz)	€/pz
1501-0002-02	9898-031-01S	BP2S 80	450x80	Avorio	2	20	80	9,580
1501-0001-02	9898-032-01S	BP1S 80	350x80	Avorio	2	24	96	9,060
1501-0005-02	9898-035-01S	BP2S 100	450x100	Avorio	2	20	240	11,540
1501-0004-02	9898-036-01S	BP1S 100	350x100	Avorio	2	24	96	10,200

## T-BPS 80-100

Tappi per basi a pavimento BPS 80-100 in scatola



Cod. europeo	Cod. fabbrica	Tipo	Dimensioni	Colore	Conf. (pz)	Imballo (pz)	Pallet (pz)	€/pz
1505-0007-01	9898-029-01	T-BPS 80	80 mm	Avorio	-	24	648	1,400
1505-0008-01	9898-040-01	T-BPS 100	100 mm	Avorio	-	24	648	1,800

## BP 80-100

Basi a pavimento leggere in PVC (coppia in termoretraibile) in film



Cod. europeo	Cod. fabbrica	Tipo	Dimensioni	Colore	Conf. (pz)	Imballo (pz)	Pallet (pz)	€/pz
1501-0004-03	0350 SP	BP1 100	100x100 - L350	Bianco	2	24	600	7,620
1501-0005-03	0450 SP	BP2 100	100x100 - L450	Bianco	2	24	480	9,010
1501-0006-03	1000 SP	BP3 100	100x100 - L1000	Bianco	2	4	240	17,380
1501-0001-03	0351 SP	BP1 80	80x80 - L350	Bianco	2	24	864	5,380
1501-0002-03	0451 SP	BP2 80	80x80 - L450	Bianco	2	24	864	6,410
1501-0003-02	1001 SP	BP3 80	80x80 - L1000	Bianco	2	4	280	14,380

## T-BP 80-100

Tappi per basi a pavimento BP 80-100 in scatola



Cod. europeo	Cod. fabbrica	Tipo	Dimensioni	Colore	Conf. (pz)	Imballo (pz)	Pallet (pz)	€/pz
1505-0308-03	0341 TS	T-BP 100	100x100 mm	Bianco	-	24	5760	1,800
1505-0307-02	0342 TS	T-BP 80	80x80 mm	Bianco	-	24	5760	1,400

## BP 100B

Supporti a pavimento neri

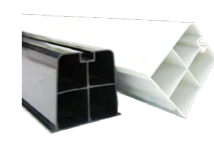

Cod. europeo	Cod. fabbrica	Tipo	Dimensioni	Colore	Conf. (pz)	Imballo (pz)	Pallet (pz)	€/pz
1501-0004-05	0502.00001.008	BP1 100B	350x100	Nero	-	12	576	9,830
1501-0005-05	0502.00002.008	BP2 100B	450x100	Nero	-	12	480	11,850
1501-0006-01	0502.00003.010	BP3 100B	1000x100	Nero	-	2	190	21,730

## TAPPO BP 100B

Tappo supporti a pavimento BP 100 B in scatola



Cod. europeo	Cod. fabbrica	Tipo	Dimensioni	Colore	Conf. (pz)	Imballo (pz)	Pallet (pz)	€/pz
1505-0308-02	0502.00018.040	T-BP 100 B	100	Nero	-	100	3200	2,260

## KAMEL

Supporto a pavimento polipropilene in scatola



Cod. europeo	Cod. fabbrica	Tipo	Dimensioni	Colore	Conf. (pz)	Imballo (pz)	Pallet (pz)	€/pz
1500-0010-01	9898-033-01	KAMEL 420	L 420 - 90x72 mm	Grigio	1	24	672	7,110
1500-0025-01	9898-052-01	KAMEL 520	L 520 - 90x72 mm	Grigio	1	24	672	8,140

## PDN

Piedino a pavimento in polipropilene in scatola



Cod. europeo	Cod. fabbrica	Tipo	Dimensioni	Colore	Conf. (pz)	Imballo (pz)	Pallet (pz)	€/pz
1502-0024-02	9898-037-01GIA	PDN W	100x100x90 mm	Avorio	4	48	1440	3,740
1502-0024-01	9898-037-95GIA	PDN B	100x100x90 mm	Nero	4	48	1440	3,740

## CONIK

Piedino conico a pavimento in polipropilene in scatola



Cod. europeo	Cod. fabbrica	Tipo	Dimensioni	Colore	Conf. (pz)	Imballo (pz)	Pallet (pz)	€/pz
1502-0016-01	0501 SC	CONIK W	105x95 mm - H90	Bianco	4	48	1440	4,500
1502-0016-02	0501 SC-B	CONIK B	105x95 mm - H90	Nero	4	48	1440	4,500

## KONG P

Supporto a pavimento con perno press-fit ad altezza fissa in scatola



Cod. europeo	Cod. fabbrica	Tipo	Dimensioni	Colore	Conf. (pz)	Imballo (pz)	Pallet (pz)	€/pz
1502-0028-03	SB9898-01SV	KONG PIN	H100	Bianco	-	4	640	5,470
1502-0028-04	SB9898-95SV	KONG PIN	H100	Nero	-	4	640	5,470

## KONG PP

Supporto a pavimento piatto con perno press-fit regolabile in altezza in scatola



Cod. europeo	Cod. fabbrica	Tipo	Dimensioni	Colore	Conf. (pz)	Imballo (pz)	Pallet (pz)	€/pz
1502-0025-01	BVP9898-01SP	KONG WPP	Ø100 - H90/140	Bianco	-	4	640	6,120
1502-0025-02	BVP9898-95SP	KONG BPP	Ø100 - H90/140	Nero	-	4	640	6,120

## KONG

Piedino a pavimento Ø100 con vite e altezza fissa, con dado da Ø 10 mm in scatola



Cod. europeo	Cod. fabbrica	Tipo	Dimensioni	Colore	Conf. (pz)	Imballo (pz)	Pallet (pz)	€/pz
1502-0028-02	SB9898-01SV	KONG W	Ø100/Ø50-H100	Avorio	-	4	640	6,440
1502-0028-01	SB9898-95SV	KONG B	Ø100/Ø50-H100	Nero	-	4	640	6,440

## KONG R

Piedino a pavimento regolabile Ø100 con vite e dado da Ø 10 mm in scatola



Cod. europeo	Cod. fabbrica	Tipo	Dimensioni	Colore	Conf. (pz)	Imballo (pz)	Pallet (pz)	€/pz
1502-0026-01	BVC9898-01SV	H120-180 mm	Ø100/Ø50 mm	Bianco	-	4	640	9,990
1502-0030-02	BVL9898-01SV	H170-220 mm	Ø100/Ø50 mm	Bianco	-	4	640	10,990
1502-0026-02	BVC9898-95SV	H120-180 mm	Ø100/Ø50 mm	Nero	-	4	640	9,990
1502-0030-04	BVL9898-95SV	H170-220 mm	Ø100/Ø50 mm	Nero	-	4	640	10,990

## KONG RP

Supporto a pavimento regolabile con perno press-fit in scatola



Cod. europeo	Cod. fabbrica	Tipo	Dimensioni	Colore	Conf. (pz)	Imballo (pz)	Pallet (pz)	€/pz
1502-0026-03	BVC9898-01SP	H120-180 mm	Ø100/Ø50 mm	Bianco	-	4	640	8,990
1502-0030-01	BVL9898-01SP	H170-220 mm	Ø100/Ø50 mm	Bianco	-	4	640	9,890
1502-0026-04	BVC9898-95SP	H120-180 mm	Ø100/Ø50 mm	Nero	-	4	640	8,990
1502-0030-03	BVL9898-95SP	H170-220 mm	Ø100/Ø50 mm	Nero	-	4	640	9,890

## BIG KONG

Supporto a pavimento regolabile Ø300 in scatola



Cod. europeo	Cod. fabbrica	Tipo	Dimensioni	Colore	Conf. (pz)	Imballo (pz)	Pallet (pz)	€/pz
1502-0027-01	PVL9898-01SV	H180/260 mm	Ø300/Ø50 mm	Bianco	-	4	120	55,600
1502-0027-02	PVL9898-95SV	H180/260 mm	Ø300/Ø50 mm	Nero	-	4	120	55,600

## IRONHIDE

Kit di supporto per unità esterne con bacinella raccogli condensa in scatola



Cod. europeo	Cod. fabbrica	Tipo	Dimensioni	Colore	Conf. (pz)	Imballo (pz)	Pallet (pz)	€/pz
1503-0600-01	9780-510-120B	IRONHIDE 120	510x120 mm	Bianco	-	1	25	155,500
1503-0600-02	9780-510-240B	IRONHIDE 240	510x240 mm	Bianco	-	1	25	194,700
1503-0636-01*	9780-510-120R	IRONHIDE 120 ICE	510x120 mm	Bianco	-	1	25	285,500
1503-0600-03*	9780-510-240R	IRONHIDE 240 ICE	510x240 mm	Bianco	-	1	25	301,300

\*Resistenza integrata



## SUPPORTO A PAVIMENTO CON ALLOGGIO PER VASSOIO RACCOGLI CONDENSA

Supporto a pavimento con alloggiamento per vassoio integrato, fornito completo di kit anti-vibrazione, in scatola



Cod. europeo	Cod. fabbrica	Tipo	Dimensioni	Colore	Conf. (pz)	Imballo (pz)	Pallet (pz)	€/pz
1503-0120-01	VS 140	350 mm	350x140 mm	RAL 9002	-	1	170	59,630
1503-0121-01	VS 240	440 mm	440x140 mm	RAL 9002	-	1	170	70,480
1503-0120-02	VS 140N	350 mm	350x140 mm	RAL 7016	-	1	170	62,550
1503-0121-02	VS 240N	440 mm	440x140 mm	RAL 7016	-	1	170	74,480

\*NB: VS 140 va usato con vassoio VS 110 e VS 240 va usato con vassoio VS 210, ulteriori informazioni su rodigas.it

## CAV 400

Supporto a pavimento con 8 punti di fissaggio in scatola



Cod. europeo	Cod. fabbrica	Tipo	Dimensioni	Colore	Conf. (pz)	Imballo (pz)	Pallet (pz)	€/pz
1503-0114-01	9794-651T	400x420	450-1000mm	RAL 9002	-	1	25	84,880

## SUPPORTO A PAVIMENTO IN ACCIAIO ELETTROZINCATO

Supporto a pavimento regolabile in acciaio elettrozincato, fornito di kit anti-vibrazione, in scatola



Cod. europeo	Cod. fabbrica	Tipo	Dimensioni	Colore	Conf. (pz)	Imballo (pz)	Pallet (pz)	€/pz
1503-0113-01	SP 700	420X250 mm	480 - 830 mm	RAL 9002	-	1	170	50,230
1503-0114-04	SP 740	420X400 mm	480 - 830 mm	RAL 9002	-	1	170	58,160
1503-0129-01	SP 850	540X400 mm	480 - 830 mm	RAL 7016	-	1	170	80,830

## SUPPORTO A PAVIMENTO IN ACCIAIO INOSSIDABILE

Supporto a pavimento regolabile in acciaio inossidabile, fornito di kit anti-vibrazione, in scatola



Cod. europeo	Cod. fabbrica	Tipo	Dimensioni	Colore	Conf. (pz)	Imballo (pz)	Pallet (pz)	€/pz
1503-0113-02	SP 701	420X250 mm	480 - 830 mm	RAL 7035	-	1	170	121,730
1503-0114-05	SP 741	420X400 mm	480 - 830 mm	RAL 7035	-	1	170	134,720

## ULTRALIGHT® PAD

Pad UltraLite® con rivestimento in fibrocemento rinforzato sfuso

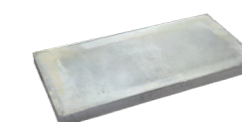

Cod. europeo	Cod. fabbrica	Tipo	Dimensioni	Colore	Conf. (pz)	Imballo (pz)	Pallet (pz)	€/pz
1504-0943-01	0502.00001.001	ULTRALIGHT 1200	1200x600	Grigio	-	1	15	114,000

## MINI SPLIT STANDS

Struttura di supporto modulare a pavimento progettata per un'installazione rapida ed efficiente, in scatola



Cod. europeo	Cod. fabbrica	Tipo	Dimensioni	Colore	Conf. (pz)	Imballo (pz)	Pallet (pz)	€/pz
1503-0111-01	SP 930	H340 - 2 bracci L50 - 700 mm		RAL 9002	☞ -	📦 1	🚚 48	94,890
1503-0112-02	SP 940	H540 - 2 bracci L50 - 700 mm		RAL 9002	☞ -	📦 1	🚚 32	118,860
1503-0211-01	SP 960	H340 - 3 bracci L100 - 700 mm		RAL 9002	☞ -	📦 1	🚚 48	104,230
1503-0212-01	SP 970	H540 - 3 bracci L100 - 700 mm		RAL 9002	☞ -	📦 1	🚚 32	128,360
1503-0111-02	SP 930N	H340 - 2 bracci L50 - 700 mm		RAL 7016	☞ -	📦 1	🚚 48	100,690
1503-0112-01	SP 940N	H540 - 2 bracci L50 - 700 mm		RAL 7016	☞ -	📦 1	🚚 32	128,810
1503-0211-02	SP 960N	H340 - 3 bracci L100 - 700 mm		RAL 7016	☞ -	📦 1	🚚 48	110,810
1503-0212-02	SP 970N	H540 - 3 bracci L100 - 700 mm		RAL 7016	☞ -	📦 1	🚚 32	139,110

## RHINO

Piede in polipropilene rinforzato con fibra di vetro per profili 41x41 mm fornito di livella a bolla, in scatola



Cod. europeo	Cod. fabbrica	Tipo	Dimensioni	Colore	Conf. (pz)	Imballo (pz)	Pallet (pz)	€/pz
1503-1323-02	C9794-300	Supporto	P300xL300 mm	Nero	☞ -	📦 12	🚚 96	22,540
1503-1323-01	C9794-300T	Supporto + tappeto antiv.	P300xL300 mm	Nero	☞ -	📦 12	🚚 96	37,560



## SUPPORTO FRAME FOOT™ MINI

Supporto della serie Frame foot™ dotato di piedi in gomma regolabili in scatola



Cod. europeo	Cod. fabbrica	Tipo	Dimensioni	Colore	Conf. (pz)	Imballo (pz)	Pallet (pz)	€/pz
1503-1017-01	0502.00030.000	755x520 mm	H330-370 mm	RAL 7021	☞ -	📦 1	🚚 40	259,700
1503-1045-01	0502.00030.001	1250x520 mm	H330-370 mm	RAL 7021	☞ -	📦 1	🚚 36	319,200

# SUMO®

## SUPPORTI IN GOMMA RICICLATA

### SUMO® - 160x90 - 21

Supporto in gomma SBR riciclata con profilo in alluminio integrato, completo di viti di fissaggio e livella a bolla, in scatola



Cod. europeo	Cod. fabbrica	Tipo	Dimensioni	Profilo	Conf. (pz)	Imballo (pz)	Pallet (pz)	€/pz
1303-0103-01	6868-025-01	SUMO 250/21	160x90 - L250	21x12 mm	-	4	240	24,220
1303-0107-01	6868-045-01	SUMO 450/21	160x90 - L450	21x12 mm	-	2	120	31,710
1303-0109-01	6868-060-01	SUMO 600/21	160x90 - L600	21x12 mm	-	2	120	42,180
1303-0111-01	6868-080-01	SUMO 800/21	160x90 - L800	21x12 mm	-	2	84	56,240
1303-0113-01*	6868-100-01	SUMO 1000/21	160x90 - L1000	21x12 mm	-	2	60	70,290
1303-0115-01*	6868-120-01	SUMO 1200/21	160x90 - L1200	21x12 mm	-	2	60	83,340

\*reggiati

### SUMO® - 160x90 - 40

Supporto in gomma SBR riciclata con profilo in alluminio integrato, completo di viti di fissaggio e livella a bolla, in scatola



Cod. europeo	Cod. fabbrica	Tipo	Dimensioni	Profilo	Conf. (pz)	Imballo (pz)	Pallet (pz)	€/pz
1303-0203-01	6868-025-04	SUMO 250/41	160x90 - L250	41x23 mm	-	4	108	25,650
1303-0207-01	6868-045-04	SUMO 450/41	160x90 - L450	41x23 mm	-	2	54	35,230
1303-0209-01	6868-060-04	SUMO 600/41	160x90 - L600	41x23 mm	-	2	54	46,870
1303-0211-01	6868-080-04	SUMO 800/41	160x90 - L800	41x23 mm	-	2	54	62,490
1303-0213-01*	6868-100-04	SUMO 1000/41	160x90 - L1000	41x23 mm	-	2	30	78,100
1303-0215-01*	6868-120-04	SUMO 1200/41	160x90 - L1200	41x23 mm	-	2	30	92,600

\*reggiati

### SUMO® LC - 160x90 - 21

Supporto in gomma SBR riciclata con profilo in alluminio integrato, completo di viti di fissaggio e livella a bolla, reggiati



Cod. europeo	Cod. fabbrica	Tipo	Dimensioni	Profilo	Conf. (pz)	Imballo (pz)	Pallet (pz)	€/pz
1302-0107-02	6868-045-01LC	SUMO LC 450/21	160x90 - L450	21x10 mm	-	2	120	22,790
1302-0109-02	6868-060-01LC	SUMO LC 600/21	160x90 - L600	21x10 mm	-	2	120	34,180
1302-0113-01	6868-100-01LC	SUMO LC 1000/21	160x90 - L1000	21x10 mm	-	2	60	51,900

### SUMO® LC - 160x90 - 40

Supporto in gomma SBR riciclata con profilo in alluminio integrato, completo di viti di fissaggio e livella a bolla, reggiati



Cod. europeo	Cod. fabbrica	Tipo	Dimensioni	Profilo	Conf. (pz)	Imballo (pz)	Pallet (pz)	€/pz
1302-0207-01	6868-045-04LC	SUMO LC 450/41	160x90 - L450	41x23 mm	-	2	120	25,070
1302-0209-01	6868-060-04LC	SUMO LC 600/41	160x90 - L600	41x23 mm	-	2	120	37,600
1302-0213-01	6868-100-04LC	SUMO LC 1000/41	160x90 - L1000	41x23 mm	-	2	60	57,090

### SUMO® EV - 180x90 - 40

Supporto in gomma SBR riciclata con profilo in alluminio integrato, completo di viti di fissaggio e livella a bolla, reggiati



Cod. europeo	Cod. fabbrica	Tipo	Dimensioni	Profilo	Conf. (pz)	Imballo (pz)	Pallet (pz)	€/pz
1304-0201-01	6868-025-04EV	SUMO EV 250/41	180x90 - L250	41x23 mm	-	2	180	23,090
1304-0205-01	6868-040-04EV	SUMO EV 400/41	180x90 - L400	41x23 mm	-	2	72	31,710
1304-0209-01	6868-060-04EV	SUMO EV 600/41	180x90 - L600	41x23 mm	-	2	96	42,180
1304-0213-01	6868-100-04EV	SUMO EV 1000/41	180x90 - L1000	41x23 mm	-	2	24	70,290
1304-0215-01	6868-120-04EV	SUMO EV 1200/41	180x90 - L1200	41x23 mm	-	2	24	84,350

### SUMO® XT - 190x95 - 40

Supporto in gomma SBR riciclata con profilo in alluminio integrato, completo di viti di fissaggio e livella a bolla, reggiati

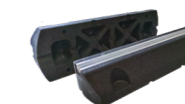

Cod. europeo	Cod. fabbrica	Tipo	Dimensioni	Profilo	Conf. (pz)	Imballo (pz)	Pallet (pz)	€/pz
1306-0216-01	6868-024-04XT	SUMO XT 240/41	190x95 - L240	41x23 mm	-	2	240	26,930
1306-0205-01	6868-040-04XT	SUMO XT 400/41	190x95 - L400	41x23 mm	-	2	144	36,990
1306-0209-01	6868-060-04XT	SUMO XT 600/41	190x95 - L600	41x23 mm	-	2	96	49,210
1306-0213-01	6868-100-04XT	SUMO XT 1000/41	190x95 - L1000	41x23 mm	-	2	48	82,010
1306-0215-01	6868-120-04XT	SUMO XT 1200/41	190x95 - L1200	41x23 mm	-	2	48	97,230

## SUMO® SM - 110x90 - 21

Supporto in gomma SBR riciclata con profilo in alluminio integrato, completo di viti di fissaggio e livella a bolla, reggiati



Cod. europeo	Cod. fabbrica	Tipo	Dimensioni	Profilo	Conf. (pz)	Imballo (pz)	Pallet (pz)	€/pz
1301-0107-01	6868-045-01SM	SUMO SM 450/21	110x90-L450	21x10 mm	-	2	180	19,780
1301-0109-01	6868-060-01SM	SUMO SM 600/21	110x90-L600	21x10 mm	-	2	180	26,370
1301-0207-01*	6868-045-04SM-PP	SUMO SM 450P	110x90 - L450	23.5x41 mm	-	2	196	16,690

\*Profilo in PVC

## SUMO® SM - 110x90 - 40

Supporto in gomma SBR riciclata con profilo in alluminio integrato, completo di viti di fissaggio e livella a bolla, reggiati



Cod. europeo	Cod. fabbrica	Tipo	Dimensioni	Profilo	Conf. (pz)	Imballo (pz)	Pallet (pz)	€/pz
1301-0207-02	6868-045-04SM	SUMO SM 450/41	110x90 - L450	41x23 mm	-	2	200	20,770
1301-0209-01	6868-060-04SM	SUMO SM 600/41	110x90 - L600	41x23 mm	-	2	180	27,690

## SUMO® B CON ALLOGGIAMENTO 41X41

Piedi per profili standard 41x41 realizzati in gomma riciclata, con livella a bolla, in scatola



Cod. europeo	Cod. fabbrica	Tipo	Dimensioni	Profilo	Conf. (pz)	Imballo (pz)	Pallet (pz)	€/pz
1303-0403-01	6868-025-07	SUMO 250 B	250x160x90	41x41 mm	-	4	108	23,590
1303-0407-01	6868-045-07	SUMO 450 B	450x160x90	41x41 mm	-	2	120	27,470
1303-0409-01	6868-060-07	SUMO 600 B	600x160x90	41x41 mm	-	2	120	40,560
1303-0413-01	6868-100-07	SUMO 1000 B	1000x160x90	41x41 mm	-	2	60	66,050

## BABY SUMO®

Mini supporto a pavimento anti-vibrazione realizzato in gomma riciclata, con livella a bolla, in scatola



Cod. europeo	Cod. fabbrica	Tipo	Dimensioni	Attacco	Conf. (pz)	Imballo (pz)	Pallet (pz)	€/pz
1314-0601-01	6868-245-01	BABY SUMO	100x100xH100	M10 - Maschio	-	4	300	12,200
1314-0501-01	6868-245-01F	BABY SUMO F	100x100xH100	M10 - Femmina	-	4	276	12,200

## BABY SUMO® R

Supporto a pavimento regolabile in altezza e realizzato in gomma riciclata, con livella a bolla, in scatola



Cod. europeo	Cod. fabbrica	Tipo	Dimensioni	Attacco	Conf. (pz)	Imballo (pz)	Pallet (pz)	€/pz
1307-0702-01	6868-016-FT	BABY SUMO R	160 x 160 x H120 - 200 mm	M10 Maschio	-	4	488	22,660

## SUMO® BLOCK XT- 190X125

Rialzo per sollevare unità esterne, compatibile con Sumo® XT reggiati



Cod. europeo	Cod. fabbrica	Tipo	Dimensioni	Compatibile	Conf. (pz)	Imballo (pz)	Pallet (pz)	€/pz
1311-0009-01	6868-060-SXT	SUMO BLOCK XT 600	190x125 - L600	1306-0209-01	-	2	80	34,780
1311-0013-01	6868-100-SXT	SUMO BLOCK XT 1000	190x125 - L1000	1306-0213-01	-	2	48	61,300
1311-0015-01	6868-120-SXT	SUMO BLOCK XT 1200	190x125 - L1200	1306-0215-01	-	2	48	69,560

## SUMO® BLOCK - 160x110

Rialzo per sollevare unità esterne, compatibile con Sumo® e Sumo® LC reggiati



Cod. europeo	Cod. fabbrica	Tipo	Dimensioni	Compatibile	Conf. (pz)	Imballo (pz)	Pallet (pz)	€/pz
1310-0003-01	6868-025-S	SUMO BLOCK 250	160x110 - L250	1303-0103-01 1303-0203-01	-	2	240	18,970
1310-0007-01	6868-045-S	SUMO BLOCK 450	160x110 - L450	1303-0107-01 1303-0207-01 1302-0107-02 1302-0207-01	-	2	90	29,190
1310-0009-01	6868-060-S	SUMO BLOCK 600	160x110 - L600	1303-0109-01 1303-0209-01 1302-0109-02 1302-0209-01	-	2	60	34,780
1310-0013-01	6868-100-S	SUMO BLOCK 1000	160x110 L1000	1303-0113-01 1303-0213-01 1302-0113-01 1302-0213-01	-	2	60	61,300
1310-0015-01	6868-120-S	SUMO BLOCK 1200	160x110 L1200	1303-0115-01 1303-0215-01	-	2	60	69,560

**SIMPLIFY  
YOUR  
WORK**



# 12. SCARICO DELLA CONDENZA



Lo scarico della condensa è un aspetto cruciale della manutenzione dei sistemi HVAC. La corretta gestione della condensa previene i danni causati dall'acqua, protegge le apparecchiature e garantisce prestazioni ottimali del sistema. Senza una gestione efficace, l'umidità eccessiva può portare a corrosione, proliferazione delle muffe e aumento dei costi di manutenzione.

Tali soluzioni per la gestione della condensa sono innovative e offrono prestazioni affidabili e richiedono uno sforzo minimo per l'installazione e la manutenzione. Questi sistemi sono progettati per raccogliere, trasportare e smaltire in modo efficiente la condensa, garantendo il funzionamento sicuro delle unità HVAC in vari ambienti.

Caratteristiche chiave come componenti durevoli, design compatti e facilità di integrazione rendono queste soluzioni una parte essenziale delle installazioni HVAC.

SCOPRI DI PIÙ,  
INQUADRA IL  
QR CODE



## Dati tecnici

Realizzato in PVC rigido, resistente agli urti, al fuoco e ai raggi UV.

Prestazioni di alta qualità, utilizzabili da -20 °C a +60 °C in posizione statica.

## Acquaring®

L'innovativa linea di raccordi Acquaring® è stata appositamente progettata per fornire la massima facilità di installazione e tenuta idraulica di lunga durata. Ogni componente è dotato di O-ring integrati, che eliminano la necessità di materiali di tenuta aggiuntivi quali collanti specifici e riducono significativamente i tempi di installazione e il rischio di perdite. Questo design avanzato garantisce connessioni durevoli e affidabili anche in condizioni operative difficili, rendendo Acquaring® la soluzione ideale per la gestione dello scarico della condensa.

## Raccordi rigidi con guarnizioni premium

Questi prodotti compongono una gamma di accessori di alta qualità per tubi di scarico condensa in PVC rigido. Utilizzato con adesivo specifico per PVC, garantisce un legame forte, durevole e resistente alle intemperie, adatto anche per utilizzo sottotraccia. Progettata con precisione per un perfetto accoppiamento, è ideale per installazioni professionali in cui affidabilità e prestazioni contano.

**niccons**  
HVAC MANUFACTURING

**ARTIPLASTIC**  
SMART PLASTIC SOLUTIONS

**Castel**  
engineering

## TUBO DI SCARICO RIGIDO

Tubo di scarico rigido realizzato in PVC autoestinguente per l'uso in sistemi di scarico della condensa con fluidi non in pressione in scatola



Cod. europeo	Cod. fabbrica	Dimensioni	Colore	Conf. (m)	Imballo (m)	Pallet (m)	€/m
1402-0305-01	9903-001-08	ø 20 mm - 2 m	Bianco	-	30	3630	1,860
1402-0405-01	9904-001-08	ø 25 mm - 2 m	Bianco	-	18	2178	3,120
1402-0505-01	9905-001-08	ø 32 mm - 2 m	Bianco	-	10	1210	4,680
1402-0311-01	0513.00001.031	ø 20 mm - 2 m	Nero	-	100	4000	2,330

# ACQUARING® CONNETTORI CON O-RING

## C90 OR

Connettore a 90° con tecnologia O-ring integrata, garantisce connessioni durevoli e affidabili senza bisogno di colla, in scatola



Cod. europeo	Cod. fabbrica	Tipo	Colore	Conf. (pz)	Imballo (pz)	Pallet (pz)	€/pz
1405-1105-06	2014 COR	ø 20 mm	Bianco	-	20	8000	2,890
1405-1205-06	2514 COR	ø 25 mm	Bianco	-	20	4800	3,050
1405-1305-06	3214 COR	ø 32 mm	Bianco	-	20	3040	3,760
1405-1111-01	2014 COR-B	ø 20 mm	Nero	-	20	8000	3,610

## C45 OR

Connettore a 45° con tecnologia O-ring integrata, garantisce connessioni durevoli e affidabili senza bisogno di colla, in scatola



Cod. europeo	Cod. fabbrica	Tipo	Colore	Conf. (pz)	Imballo (pz)	Pallet (pz)	€/pz
1405-1105-07	2013 AOR	ø 20 mm	Bianco	-	20	8000	2,890
1405-1205-07	2513 AOR	ø 25 mm	Bianco	-	20	4800	3,050
1405-1305-07	3213 AOR	ø 32 mm	Bianco	-	20	3840	3,760
1405-1111-02	2013 AOR-B	ø 20 mm	Nero	-	20	8000	3,610

## RT1 OR

Connettore a "T" con tecnologia O-ring integrata, garantisce connessioni durevoli e affidabili senza bisogno di colla, in scatola



Cod. europeo	Cod. fabbrica	Tipo	Colore	Conf. (pz)	Imballo (pz)	Pallet (pz)	€/pz
1405-1105-08	2015 DOR	ø 20 mm	Bianco	-	20	4800	3,700
1405-1205-08	2515 DOR	ø 25 mm	Bianco	-	20	3040	4,090
1405-1305-08	3215 DOR	ø 32 mm	Bianco	-	20	2280	4,410
1405-1111-03	2015 DOR-B	ø 20 mm	Nero	-	20	4800	4,630

## MFF OR

Giunzione con tecnologia O-ring integrata, garantisce connessioni durevoli e affidabili senza bisogno di colla, in scatola



Cod. europeo	Cod. fabbrica	Tipo	Colore	Conf. (pz)	Imballo (pz)	Pallet (pz)	€/pz
1405-1105-09	2012 MOR	ø 20 mm	Bianco	-	20	8000	2,600
1405-1205-09	2512 MOR	ø 25 mm	Bianco	-	20	4800	2,790
1405-1305-09	3212 MOR	ø 32 mm	Bianco	-	20	4800	3,540
1405-1111-04	2012 MOR-B	ø 20 mm	Nero	-	30	8000	3,240

## GRF

Connettore rigido-flessibile usato per collegare tubi spiralati o corrugati di tutte le misure in scatola



Cod. europeo	Cod. fabbrica	Tipo	Colore	Conf. (pz)	Imballo (pz)	Pallet (pz)	€/pz
1405-0305-06	2006 FR	ø 20 mm	Bianco	-	20	8000	0,870
1405-0405-07	2506 FR	ø 25 mm	Bianco	-	20	8000	0,910
1405-0505-07	3206 FR	ø 32 mm	Bianco	-	20	8000	0,960

## CLIP

Per fissare il tubo di scarico rigido alla parete in scatola



Cod. europeo	Cod. fabbrica	Tipo	Colore	Conf. (pz)	Imballo (pz)	Pallet (pz)	€/pz
1405-0305-01	9903-107-00	ø 20 mm	Bianco	-	30	7500	0,480
1405-0405-01	9904-107-00	ø 25 mm	Bianco	-	30	7500	0,660
1405-0505-01	9905-107-00	ø 32 mm	Bianco	-	30	7500	0,790
1405-0311-03	0513.00004.031	ø 20 mm	Nero	-	500	32000	0,600

## ROR

Riduttore utilizzato per collegare tubi spiralati o corrugati di tutte le misure in scatola



Cod. europeo	Cod. fabbrica	Tipo	Colore	Conf. (pz)	Imballo (pz)	Pallet (pz)	€/pz
1405-1205-10	2520RR	ø 25-20 mm	Bianco	-	20	8000	2,580
1405-1305-10	3225RR	ø 32-25 mm	Bianco	-	20	4800	3,550

# CONNESSIONI RIGIDE CON GUARNIZIONI PREMIUM

## C45

Curva a 45° progettata per essere utilizzata senza collanti o con adesivo specifico per PVC per una massima tenuta anche sottotraccia, in scatola



Cod. europeo	Cod. fabbrica	Tipo	Colore	Conf. (pz)	Imballo (pz)	Pallet (pz)	€/pz
1405-1105-01	9903-101-08	ø 20 mm	Bianco	-	30	4800	2,410
1405-1205-01	9904-101-08	ø 25 mm	Bianco	-	30	4800	2,570
1405-1305-01	9905-101-08	ø 32 mm	Bianco	-	30	4800	2,650

## C90

Curva a 90° progettata per essere utilizzata senza collanti o con adesivo specifico per PVC per una massima tenuta anche sottotraccia, in scatola



Cod. europeo	Cod. fabbrica	Tipo	Colore	Conf. (pz)	Imballo (pz)	Pallet (pz)	€/pz
1405-1105-02	9903-102-08	ø 20 mm	Bianco	-	30	4800	2,710
1405-1205-02	9904-102-08	ø 25 mm	Bianco	-	30	4800	2,860
1405-1305-02	9905-102-08	ø 32 mm	Bianco	-	30	4800	3,320

## MFF

Manicotto femmina-femmina da utilizzare senza collanti o con adesivo specifico per PVC per una massima tenuta anche sottotraccia, in scatola



Cod. europeo	Cod. fabbrica	Tipo	Colore	Conf. (pz)	Imballo (pz)	Pallet (pz)	€/pz
1405-1105-03	9903-103-08	ø 20 mm	Bianco	-	30	4800	2,410
1405-1205-03	9904-103-08	ø 25 mm	Bianco	-	30	4800	2,480
1405-1305-03	9905-103-08	ø 32 mm	Bianco	-	30	4800	2,870

## RMF

Riduzione maschio-femmina da utilizzare senza collanti o con adesivo specifico per PVC per una massima tenuta anche sottotraccia, in scatola



Cod. europeo	Cod. fabbrica	Tipo	Colore	Conf. (pz)	Imballo (pz)	Pallet (pz)	€/pz
1405-0005-01	9903-104-08	M25 - F20 mm	Bianco	-	30	4800	2,390
1405-0005-02	9904-104-08	M32 - F20 / F25 mm	Bianco	-	30	4800	2,540

## RT1

Connettore a "T" da utilizzare senza collanti o con adesivo specifico per PVC per una massima tenuta anche sottotraccia, in scatola



Cod. europeo	Cod. fabbrica	Tipo	Colore	Conf. (pz)	Imballo (pz)	Pallet (pz)	€/pz
1405-1105-04	9903-105-08	ø 20 mm	Bianco	-	30	4800	3,300
1405-1205-04	9904-105-08	ø 25 mm	Bianco	-	30	4800	3,630
1405-1305-04	9905-105-08	ø 32 mm	Bianco	-	30	4800	3,820

## RP

Raccordo per scatole di predisposizione da utilizzare senza collanti o con adesivo per PVC per una massima tenuta anche sottotraccia, in scatola



Cod. europeo	Cod. fabbrica	Tipo	Colore	Conf. (pz)	Imballo (pz)	Pallet (pz)	€/pz
1405-1105-05	9903-106-08	ø 20 mm	Bianco	-	30	4800	1,710
1405-1205-05	9904-106-08	ø 25 mm	Bianco	-	30	4800	1,750
1405-1305-05	9905-106-08	ø 32 mm	Bianco	-	30	4800	1,820

# TUBO CORRUGATO E ACCESSORI

## TC WHITE

Tubo corrugato flessibile ø 16-18-20 per canalina in scatola



Cod. europeo	Cod. fabbrica	Tipo	Colore	Conf. (m)	Imballo (m)	Pallet (m)	€/m
1406-0805-01	9899-051-01	ø 16-18 mm	Bianco	-	50	2000	1,260
1406-0905-01	9899-050-01	ø 17-20 mm	Bianco	-	50	1400	1,450
1406-1005-02	9899-057-01	ø 16-18-20 mm	Bianco	-	50	700	1,530

## TC FLEXFIT

Tubo corrugato ø 16-18-20 con segni di taglio a intervalli regolari in scatola



Cod. europeo	Cod. fabbrica	Tipo	Colore	Conf. (m)	Imballo (m)	Pallet (m)	€/m
1406-1005-01	0511.00301.033	ø 16-18-20 mm	Bianco	-	50	4500	1,530

## TC RED

Tubo corrugato per scarico condensa flex biestruso rosso in scatola



Cod. europeo	Cod. fabbrica	Tipo	Colore	Conf. (m)	Imballo (m)	Pallet (m)	€/m
1406-0802-01	9899-058-01	ø 16-18 mm	Bianco/rosso	-	50	2000	1,580
1406-0902-01	9899-056-01	ø 17-20 mm	Bianco/rosso	-	50	1400	1,880

## TC BLUE

Tubo corrugato per scarico condensa flex biestruso blu in scatola



Cod. europeo	Cod. fabbrica	Tipo	Colore	Conf. (m)	Imballo (m)	Pallet (m)	€/m
1406-0803-01	9899-059-01	ø 16-18 mm	Bianco/blu	-	50	2000	1,470
1406-0903-01	9899-055-01	ø 17-20 mm	Bianco/blu	-	50	1400	1,780

## MG FR - MG FF

Manicotto di giunzione FF per collegamento tra tubi corrugati e tra tubo corrugato e tubo rigido, in scatola

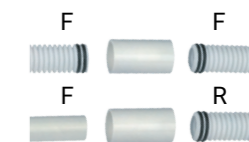

Cod. europeo	Cod. fabbrica	Tipo	Descrizione	Colore	Conf. (pz)	Imballo (pz)	Pallet (pz)	€/pz
1404-0005-05	9899-071-01	ØF20 - F24	Flex - Rigido	Bianco	-	30	4800	2,800
1404-0005-06	9899-072-01	ØF20 - F24	Flex - Flex	Bianco	-	30	4800	2,700

## R3V

Raccordo a tre vie con due ingressi femmina e un'uscita maschio completo di due guarnizioni, in scatola



Cod. europeo	Cod. fabbrica	Tipo	Colore	Conf. (pz)	Imballo (pz)	Pallet (pz)	€/pz
1404-0005-08	9899-060-01	ø F20 - M20 mm	Bianco	-	30	4800	2,390
1404-0005-09	9899-061-01	ø F18 - M18 mm	Bianco	-	30	4800	2,310
1404-0005-01	9899-062-01	ø F24 - M20 mm	Bianco	-	30	4800	3,230

## RI FM

Riduzione femmina-maschio  
in scatola



Cod. europeo	Cod. fabbrica	Tipo	Colore	Conf. (pz)	Imballo (pz)	Pallet (pz)	€/pz
1404-0005-02	9899-066-01	F Ø24 / M Ø20	Bianco	-	30	4800	2,820
1404-0005-03	9899-067-01	F Ø20 / M Ø25	Bianco	-	30	4800	2,540
1404-0005-04	9899-068-01	F Ø20 / M Ø32	Bianco	-	30	4800	2,600

## R3VL 20

Raccordo a 3 vie laterale per tubo corrugato con 2 guarnizioni  
in scatola



Cod. europeo	Cod. fabbrica	Tipo	Colore	Conf. (pz)	Imballo (pz)	Pallet (pz)	€/pz
1404-1105-01	9899-065-01	F Ø20/M Ø20	Bianco	-	30	4800	2,540

## RAD

Raccordo adattatore per tubo corrugato  
in scatola



Cod. europeo	Cod. fabbrica	Tipo	Colore	Conf. (pz)	Imballo (pz)	Pallet (pz)	€/pz
1405-0101-01	1607RU	Internal Ø16 mm	Giallo	-	20	8000	3,990
1405-0207-01	1807RU	Internal Ø18 mm	Rosso	-	20	8000	3,870
1405-0310-01	2007RU	Internal Ø20 mm	Blu	-	20	8000	3,970
1405-0409-01	2507RU	Internal Ø25 mm	Verde	-	20	8000	5,230
1405-0508-01	3207RU	Internal Ø32 mm	Bianco	-	20	4800	5,060

# TUBO SPIRALATO E ACCESSORI

## T-FLEX

Tubo spiralato flex liscio in PVC per scarico condensa  
in scatola



Cod. europeo	Cod. fabbrica	Tipo	Colore	Conf. (m)	Imballo (m)	Pallet (m)	€/m
1401-0105-01	0016TU	Ø16 mm	Bianco	-	30	4860	1,270
1401-0205-04	0018TU	Ø18 mm	Bianco	-	30	4320	1,490
1401-0305-01	0020TU	Ø20 mm	Bianco	-	30	4320	1,660

## R3V C

Raccordo a 3 vie centrali per tubo spiralato  
in scatola



Cod. europeo	Cod. fabbrica	Tipo	Colore	Conf. (pz)	Imballo (pz)	Pallet (pz)	€/pz
1404-0105-01	9899-040-01	Ø16 mm	Bianco	-	30	4800	1,790
1404-0305-01	9899-041-01	Ø20mm	Bianco	-	30	4800	1,880

## MGM

Manicotto di giunzione maschio per tubo spiralato  
in scatola

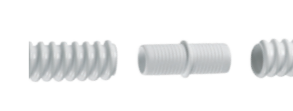

Cod. europeo	Cod. fabbrica	Tipo	Colore	Conf. (pz)	Imballo (pz)	Pallet (pz)	€/pz
1404-0105-04	9899-045-01	Ø16 mm	Bianco	-	30	7200	1,920
1404-0305-02	9899-046-01	Ø20mm	Bianco	-	30	7200	1,980

## RT

Raccordo a "T" per tubo spiralato in scatola



Cod. europeo	Cod. fabbrica	Tipo	Colore	Conf. (pz)	Imballo (pz)	Pallet (pz)	€/pz
1404-0105-02	9899-042-01	Ø16 mm	Bianco	-	25	6250	2,630
1404-0205-02	9899-044-01	Ø18mm	Bianco	-	25	6250	2,710
1404-0305-05	9899-043-01	Ø20mm	Bianco	-	25	6250	2,780

## CS90

Raccordo curva 90° per tubo spiralato in scatola



Cod. europeo	Cod. fabbrica	Tipo	Colore	Conf. (pz)	Imballo (pz)	Pallet (pz)	€/pz
1404-0105-03	9899-047-01	Ø16 mm	Bianco	-	25	6250	2,250
1404-0205-03	9899-049-01	Ø18mm	Bianco	-	30	6250	2,340
1404-0305-03	9899-048-01	Ø20mm	Bianco	-	25	6250	2,400

## RY

Connettore a Y semplice utilizzabile per il collegamento di due tubi spiralati in scatola



Cod. europeo	Cod. fabbrica	Tipo	Colore	Conf. (pz)	Imballo (pz)	Pallet (pz)	€/pz
1404-0105-05	9899-042-01-Y	Ø 16 mm	Bianco	-	25	6250	2,890
1404-0205-01	9899-043-01-Y	Ø 18 mm	Bianco	-	25	6250	3,180
1404-0305-06	9899-044-01-Y	Ø 20 mm	Bianco	-	25	6250	3,060

## RYR

Connettore a Y ridotto utilizzabile per il collegamento di due tubi spiralati in scatola



Cod. europeo	Cod. fabbrica	Tipo	Colore	Conf. (pz)	Imballo (pz)	Pallet (pz)	€/pz
1404-0005-12	9899-045-01-Y	Ingresso - Ø 18 mm Uscita - Ø 2x16 mm	Bianco	-	25	6250	3,180
1404-0005-13	9899-046-01-Y	Ingresso - Ø 20 mm Uscita - Ø 2x16 mm	Bianco	-	25	6250	3,500
1404-0005-14	9899-047-01-Y	Ingresso - Ø 20 mm Uscita - Ø 2x18 mm	Bianco	-	25	6250	3,610

## R3V U

Raccordo a 3 vie universale in scatola



Cod. europeo	Cod. fabbrica	Tipo	Colore	Conf. (pz)	Imballo (pz)	Pallet (pz)	€/pz
1404-1005-01	9899-042-01-U	Ø16/18/20mm	Bianco	-	25	6250	6,020

## RTG

Raccordo tubo-guaina per scarico condensa in scatola

540141 RTG 1  
540142 RTG 2

540145 RTG 3

1404-0005-11  
1404-0305-04



Cod. europeo	Cod. fabbrica	Tipo	Conf. (pz)	Imballo (pz)	Pallet (pz)	€/pz
1404-0005-11	9899-073-01	Interno - Ø 16 mm, esterno - Ø 20 mm	-	30	4800	2,010
1404-0005-07	9899-075-01	Interno - Ø20, esterno - Ø25 mm	-	30	4800	3,630
1404-0305-04	9899-073-01N	Interno - Ø 20 mm, esterno - Ø 20 mm	-	30	4800	5,030

## MR 24

Manicotto di riparazione in scatola



Cod. europeo	Cod. fabbrica	Tipo	Descrizione	Colore	Conf. (pz)	Imballo (pz)	Pallet (pz)	€/pz
1404-0005-10	9899-070-01	ØF24 - F24	Flex - Flex	Bianco	-	30	4800	2,330

## RYL

Raccordo a "Y" laterale per tubo spiralato  $\varnothing$  16-18 e per tubo corrugato in scatola



Cod. europeo	Cod. fabbrica	Tipo	Conf. (pz)	Imballo (pz)	Pallet (pz)	€/pz
1404-1006-02	0021GY	Ingresso - $\varnothing$ 16 mm, uscita - $\varnothing$ 18 mm	-	20	4800	1,400

## R3V UA

Raccordo universale per tubo spiralato e per tubo corrugato  $\varnothing$  16-18-20 in scatola



Cod. europeo	Cod. fabbrica	Tipo	Conf. (pz)	Imballo (pz)	Pallet (pz)	€/pz
1404-1006-03	0022YU	Ingresso - $\varnothing$ 16 mm, uscita - $\varnothing$ 18/20 mm	-	20	3840	1,950

## RT U

Giunto a "T" per tubi di scarico della condensa.  
Per tubi spiralati  $\varnothing$  16,  $\varnothing$  18,  $\varnothing$  20 e per tubi corrugati  $\varnothing$  16,  $\varnothing$  20 in scatola



Cod. europeo	Cod. fabbrica	Tipo	Conf. (pz)	Imballo (pz)	Pallet (pz)	€/pz
1404-1006-05	0025GT	Rigido - $\varnothing$ 16-20 mm, Corrugato - $\varnothing$ 16/18/20 mm	-	20	4800	2,230

## GL U

Giunzione lineare universale  $\varnothing$  16-18-20 in scatola



Cod. europeo	Cod. fabbrica	Tipo	Conf. (pz)	Imballo (pz)	Pallet (pz)	€/pz
1404-1006-04	0023GL	$\varnothing$ 16/18/20 mm	-	20	8000	0,980

## RY 20-18

Collegamento a "Y" per tubi scarico condensa in scatola



Cod. europeo	Cod. fabbrica	Tipo	Conf. (pz)	Imballo (pz)	Pallet (pz)	€/pz
1404-1005-02	0511.00003.022	In alto: 2x $\varnothing$ 20 mm, in basso: 1x $\varnothing$ 18 mm	-	200	9600	3,790

## SIF 0

Sifone in PVC rigido e trasparente, utilizzato per evitare il problema dei cattivi odori provenienti dal tubo di scarico della condensa. in scatola



Cod. europeo	Cod. fabbrica	Tipo	Conf. (pz)	Imballo (pz)	Pallet (pz)	€/pz
1404-1006-01	0024SF	Ingresso - $\varnothing$ 16 mm, uscita - $\varnothing$ 18/20 mm	-	10	2400	3,020

## G-FIX

Base con fascetta per tubi in scatola



Cod. europeo	Cod. fabbrica	Tipo	Conf. (pz)	Imballo (pz)	Pallet (pz)	€/pz
1405-0901-01	540261	Per tubi $\varnothing$ 16-32mm	50	400	10.800	0,310
1405-0901-02	540262	Per tubi $\varnothing$ 40-63mm	25	200	5.400	0,510

## SIF RIG

Sifone per tubo di scarico rigido  
Evita i cattivi odori. Può essere installato verticalmente e orizzontalmente. in scatola



Cod. europeo	Cod. fabbrica	Tipo	Conf. (pz)	Imballo (pz)	Pallet (pz)	€/pz
1405-1005-01	0514.00007.022	Esterno - $\varnothing$ 20 mm, interno - $\varnothing$ 16/18 mm	-	20	1280	19,200

## COLLA PVC-U

Adesivo specifico per PVC, crea un legame super forte tra tubi e accessori in scatola



Cod. europeo	Cod. fabbrica	Conf. (pz)	Imballo (pz)	Pallet (pz)	€/pz
1703-2500-01	4000TG	-	12	-	18,790

## SIFR

Sifone ad incasso con rubinetto



Cod. europeo	Cod. fabbrica	Tipo	Conf. (pz)	Imballo (pz)	Pallet (pz)	€/pz
1409-0005-01	9899-023-01	Per tubi ø 20 mm	-	1	200	38,510

## SIF1

Sifone per scatole di predisposizione



Cod. europeo	Cod. fabbrica	Tipo	Conf. (pz)	Imballo (pz)	Pallet (pz)	€/pz
1409-0005-02	9899-027-01	Per tubi ø 20 mm	-	1	200	14,770

**SIMPLIFY  
YOUR  
WORK**

# 13. SCATOLE DI PREDISPOSIZIONE AD INCASSO



NICCONS, storica produttrice di componenti per climatizzazione, propone scatole di predisposizione affidabili e versatili per impianti civili e industriali.

Un elemento distintivo è il sistema brevettato Freestop, dotato di guarnizione O-ring contro i cattivi odori e di coperchio con griglia, che protegge il galleggiante da tubi e impurità. Con l'aumento del livello dell'acqua di condensa, il galleggiante si solleva automaticamente per il deflusso; al termine dello scarico, si abbassa chiudendo ermeticamente il passaggio.

Realizzate con materiali di alta qualità e secondo rigorosi standard, le scatole di predisposizione garantiscono prestazioni costanti, facilità di manutenzione e massima affidabilità.

SCOPRI DI PIÙ,  
INQUADRA IL  
QR CODE



## EBOX

Scatola di predisposizione "Ebox", scatola, convogliatore di condensa e coperchio in scatola con protezione per le fasi di intonacatura



Cod. europeo	Cod. fabbrica	Dimensioni	Direzione uscita	Conf. (pz)	Imballo (pz)	Pallet (pz)	€/pz
1403-1405-01	0012 EBO	430x95x65 mm	Orizzontale	-	20	400	10,550
1403-1505-01	0014 EBO	530x95x65 mm	Orizzontale	-	20	400	14,530
1403-1405-02	0013 EBV	430x95x65 mm	Verticale	-	25	500	10,550
1403-1505-02	0015 EBV	530x95x65 mm	Verticale	-	20	400	14,530

## CLIMABOX STOP

Il sistema Freestop è dotato di una guarnizione O-ring di tenuta contro i cattivi odori e di un apposito coperchio per evitare che i tubi incidano sul funzionamento del galleggiante.



Cod. europeo	Cod. fabbrica	Dimensioni	Conf. (pz)	Imballo (pz)	Pallet (pz)	€/pz
1403-1920-01	9899-220-01	430x130x65 mm	-	24	384	22,610

## CLIMABOX

Dotata di due uscite laterali Ø20 mm presfondabili e di riduzione per tubo Ø16-18 mm, completa di "Fix Dima"



Cod. europeo	Cod. fabbrica	Dimensioni	Conf. (pz)	Imballo (pz)	Pallet (pz)	€/pz
1403-1914-01	9899-001-01	430x130x65 mm	-	24	384	13,910

## UNIVERSAL

Caratterizzata da un'uscita laterale Ø20-16 mm completa di bacinella reversibile inclinata per lo scarico della condensa.



Cod. europeo	Cod. fabbrica	Dimensioni	Conf. (pz)	Imballo (pz)	Pallet (pz)	€/pz
1403-2215-01	9899-002-01	485x125x60 mm	-	30	480	15,500

## SLIM

Caratterizzata da un'uscita laterale Ø16-20 mm, fornita con "Fix Jig" da ancorare al fondo della predisposizione ed utile per fissare la dima del condizionatore.



Cod. europeo	Cod. fabbrica	Dimensioni	Conf. (pz)	Imballo (pz)	Pallet (pz)	€/pz
1403-2317-01	9899-006-01	380x120x55 mm	-	30	480	9,180

## CLIMABALL

Dotata di sfera galleggiante e bacinella reversibile.



Cod. europeo	Cod. fabbrica	Dimensioni	Conf. (pz)	Imballo (pz)	Pallet (pz)	€/pz
1403-2119-01	9899-221-01	450x100x60 mm	-	24	384	32,130

## IDROBOX

Dotata di due uscite laterali Ø20 mm presfondabili e di riduzione per tubo Ø16-18 mm. Completa di "Fix Dima".



Cod. europeo	Cod. fabbrica	Dimensioni	Conf. (pz)	Imballo (pz)	Pallet (pz)	€/pz
1403-2516-02	9899-008-01	500x170x65 mm	-	12	192	16,200

## IDROBOX STOP

Il sistema Freestop è dotato di una guarnizione O-ring di tenuta contro i cattivi odori e di un apposito coperchio per evitare che i tubi intervengano sul funzionamento del galleggiante.



Cod. europeo	Cod. fabbrica	Dimensioni	Conf. (pz)	Imballo (pz)	Pallet (pz)	€/pz
1403-2516-01	9899-009-01	520x170x65 mm	-	12	192	27,090

## KS 19-32

Kit di scarico per vassoi raccogli condensa.  
Adattabile a tutti gli standard di mercato.  
Composto da: valvola di scarico con gancio e guarnizioni e tappi.



Cod. europeo	Cod. fabbrica	Descrizione	Conf. (pz)	Imballo (pz)	Pallet (pz)	€/pz
1400-0005-01	C9899-01	Ø 19 mm	-	10	2500	5,280
1400-0005-02	C9899-32	Ø 32 mm	-	10	2500	5,650

## FREESTOP

Galleggiante antiodore per scatole di predisposizione in scatola



Cod. europeo	Cod. fabbrica	Dimensioni	Conf. (pz)	Imballo (pz)	Pallet (pz)	€/pz
1403-0020-01	1403-0020-01	485x125x600 mm	-	25	4000	4,500

## RSP 90

Raccordo a 90° per collegare cassette di predisposizione con tubo corrugato in scatola



Cod. europeo	Cod. fabbrica	Dimensioni	Conf. (pz)	Imballo (pz)	Pallet (pz)	€/pz
1403-3000-01	9899-064-01	Ø 16-18 mm	-	30	4800	1,920

## RSP

Raccordo dritto per collegare cassette di predisposizione con tubo corrugato in scatola



Cod. europeo	Cod. fabbrica	Dimensioni	Conf. (pz)	Imballo (pz)	Pallet (pz)	€/pz
1403-3000-02	9899-069-01	Ø 16-18 mm	-	10	4800	1,920

## VS 110-120

Vassoio raccolta condensa in acciaio elettrozincato



Cod. europeo	Cod. fabbrica	Dimensioni	Colore	Conf. (pz)	Imballo (pz)	Pallet (pz)	€/pz
1408-1612-02	VS110	800 x 340 mm	Bianco	-	1	45	53,830
1408-1712-01	VS210	1000 x 420mm	Bianco	-	50	27	66,770
1408-1613-02	VS110N	800 x 340 mm	Nero	-	1	45	57,040
1408-1713-01	VS210N	1000 x 420mm	Nero	-	50	27	72,060

## STAFFE PER VASSOIO RACCOLTA CONDENZA

Staffe di montaggio per vassoio raccolta condensa in acciaio elettrozincato



Cod. europeo	Cod. fabbrica	Dimensioni	Colore	Conf. (pz)	Imballo (pz)	Pallet (pz)	€/pz
1408-1612-01	VS 120	340 mm	Bianco	-	10	600	27,170
1408-1712-02	VS 220	420mm	Bianco	-	50	300	29,980
1408-1613-01	VS 120N	340 mm	Nero	-	10	600	29,140
1408-1713-02	VS 220N	420mm	Nero	-	10	300	31,890

## SUPPORTO A PAVIMENTO CON ALLOGGIO PER VASSOIO RACCOGLI CONDENZA

Supporto a pavimento con alloggiamento per vassoio integrato, fornito completo di kit anti-vibrazione, in scatola



Cod. europeo	Cod. fabbrica	Tipo	Dimensioni	Colore	Conf. (pz)	Imballo (pz)	Pallet (pz)	€/pz
1503-0120-01	VS 140	350 mm	350x140 mm	RAL 9002	-	1	170	59,630
1503-0121-01	VS 240	440 mm	440x140 mm	RAL 9002	-	1	170	70,480
1503-0120-02	VS 140N	350 mm	350x140 mm	RAL 7016	-	1	170	62,550
1503-0121-02	VS 240N	440 mm	440x140 mm	RAL 7016	-	1	170	74,480

\*NB: VS 140 va usato con vassoio VS 110 e VS 240 va usato con vassoio VS 210, ulteriori informazioni su rodigas.it

## KIT VASSOIO PER CONDENSA

Kit vassoio raccogli condensa universale in HIPS, completo di staffe di montaggio. Adattabile a qualsiasi mensola o supporto a pavimento



Cod. europeo	Cod. fabbrica	Tipo	Descrizione	Conf. (pz)	Imballo (pz)	Pallet (pz)	€/pz
1408-0005-03	9899-098-01S	BAC 1	790x390 mm	-	1	40	67,500
1408-0005-01	9899-099-01S	BAC 2	940x420 mm	-	1	40	69,900

## KIT VASSOIO PER CONDENSA CON RESISTENZA E TERMOSTATO

Kit vassoio raccogli condensa universale in HIPS, completo di staffe di montaggio, resistenza e termostato. Adattabile a qualsiasi mensola o supporto a pavimento

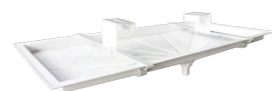

Cod. europeo	Cod. fabbrica	Tipo	Descrizione	Conf. (pz)	Imballo (pz)	Pallet (pz)	€/pz
1408-0005-04	9899-098-01-RES	BAC 1 ICE	790x390 mm	-	1	40	152,310
1408-0005-02	9899-099-01-RES	BAC 2 ICE	940x420 mm	-	1	40	155,560

**SIMPLIFY  
YOUR  
WORK**



# 14. PRODOTTI COMPLEMENTARI



Quando si tratta di sistemi HVAC ogni dettaglio conta. Oltre ai componenti principali, sono i piccoli ma essenziali accessori che garantiscono massime prestazioni e affidabilità duratura.

La nostra gamma di prodotti complementari di alta qualità è progettata per migliorare funzionalità ed efficienza delle installazioni HVAC, allungandone notevolmente la loro durata nel tempo.

Realizzati con cura e precisione, sono indispensabili per raggiungere la massima efficienza e un'eccellente operatività dei sistemi HVAC nel lungo periodo.

SCOPRI DI PIÙ,  
INQUADRA IL  
QR CODE



## HB - SCATOLA PER COLLETTORI

Scatola ad incasso



Cod. europeo	Cod. fabbrica	Tipo	Dimensioni	Conf. (pz)	Imballo (pz)	Pallet (pz)	€/pz
1711-1800-04	6501-110-01	HB 2 2 VIE	L175xH260xP82 mm	-	10	80	29,820
1711-1800-05	6501-111-01	HB 3 3 VIE	L241xH260xP82 mm	-	10	20	32,060
1711-1800-06	6501-112-01	HB 4 4 VIE	L307xH260xP82 mm	-	10	80	33,980
1711-1800-07	6501-113-01	HB 5 5 VIE	L370xH310xP82 mm	-	5	80	37,380

## SC - SCATOLA PER COLLETTORI

Scatola ad incasso con collettore



Cod. europeo	Cod. fabbrica	Tipo	Dimensioni	Conf. (pz)	Imballo (pz)	Pallet (pz)	€/pz
1711-1800-01	6501-010-01	SC 2 - 2 VIE	L175xH260xP82 mm	-	10	80	82,270
1711-1800-02	6501-011-01	SC 3 - 3 VIE	L241xH260xP82 mm	-	10	20	99,310
1711-1800-03	6501-012-01	SC 4 - 4 VIE	L307xH260xP82 mm	-	10	80	112,610
1711-1800-08	9899-007-801	SC 5 - 5 VIE	L370xH310xP82 mm	-	5	80	185,000

## DEFLETTORI D'ARIA

Vite nascosta dopo l'installazione (solo per 5001 DF e 5002 DF);  
Lastra di isolamento anticondensazione inclusa (solo per 5001 DF e 5002 DF)



Cod. europeo	Cod. fabbrica	Dimensioni	Caso d'uso	Conf. (pz)	Imballo (pz)	Pallet (pz)	€/pz
1710-1800-01	5001DF	690x240x45 mm	Unità interna split	-	1	44	88,560
1710-1800-02	5002DF	800x300x60 mm	Unità interna split	-	1	30	100,950
1710-1800-03	5003DF	500x130x100 mm	Cassetta a soffitto	-	1	70	78,020

## EASYBEND®

Pratico kit di sonde curvatubi per piegare facilmente le tubazioni in rame dei climatizzatori senza rischio di attorcigliamenti o danni all'isolamento. Ideale per l'installazione di sistemi tipo split



Cod. europeo	Cod. fabbrica	Tipo	Dimensioni	Colore	Conf. (kit)	Imballo (kit)	Pallet (kit)	€/kit
1703-1900-05	6504SCP-04	Ø 4 mm / 1/4"	L 4 m	Rosso	1	5	120	117,600
				Verde				
				Giallo				
				Blu				
				Bianco				
1703-1900-03	6214SCP-04	Ø 4 mm / 1/4"	L 4 m	Rosso	1	30	360	27,780
				Verde				
1703-1900-04	6234SCP-04	Ø 9 mm / 1/2"	L 4 m	Giallo	1	20	240	66,980
				Blu				
1703-1900-01	6404SCP-04	Ø 4 mm / 1/4"	L 4 m	Rosso	1	9	216	86,300
				Verde				
				Giallo				
				Blu				

## SPIN TOOLS®

Progettati per la maggior parte dei diametri dei tubi, consentono di collegare i tubi senza la necessità di raccordi aggiuntivi (ricalcatura) e preservano la malleabilità del rame (svasatura), prevenendo così crepe e perdite



Cod. europeo	Cod. fabbrica	Dimensioni	Caso d'uso	Conf. (pz)	Imballo (pz)	Pallet (pz)	€/pz
1703-0500-02	0516.00003.001	1/4", 3/8", 1/2", 5/8"	Svasatura	-	50	2700	99,000
1703-0500-03	0516.00003.002	1/4", 3/8", 1/2", 5/8", 3/4", 7/8"	Svasatura	-	50	1350	165,000
1703-0500-04	0516.00003.003	1/4", 3/8", 1/2", 5/8"	Ricalcatura	-	50	2700	112,000
1703-0500-05	0516.00003.004	1/4", 3/8", 1/2", 5/8", 3/4", 7/8"	Ricalcatura	-	50	1350	182,000

## CANAL CUT

Tagliacanaline premium



Cod. europeo	Cod. fabbrica	Dimensioni supportate (mm)	Conf. (pz)	Imballo (pz)	Pallet (pz)	€/pz
1703-1700-01	2100VD	25x25 - 35x30 - 60x45 - 70x55 - 80x60 - 90x65	-	1	-	250,740

## LAMA DI RICAMBIO PER CANAL CUT

Lame di ricambio



Cod. europeo	Cod. fabbrica	Dimensioni	Compatibile con	Conf. (pz)	Imballo (pz)	Pallet (pz)	€/pz
1703-1700-03	2101BD	F4000	1703-1700-01	-	10	-	74,590

## CANAL CUT E

Tagliacanaline



Cod. europeo	Cod. fabbrica	Dimensioni (mm)	Conf. (pz)	Imballo (pz)	Pallet (pz)	€/pz
1703-1700-02	A-100-030	35x30 - 65x50 - 70x55 - 80x60 - 90x65	-	1	-	132,020

## NASTRO IN ALLUMINIO

I nastri in alluminio garantiscono un'elevata resistenza al calore e alla luce. Ottimale per la sigillatura e la protezione, garantisce un'elevata finitura estetica all'isolamento.

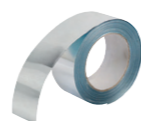

Cod. europeo	Cod. fabbrica	Lunghezza	Spessore	Larghezza	Conf. (pz)	Imballo (pz)	Pallet (pz)	€/pz
1708-0300-01	0050NAL	50 m	3 µm	50 mm	1	24	864	13,760

## USCITA A TETTO IN ALLUMINIO

Uscita a tetto.



Cod. europeo	Cod. fabbrica	Dimensioni tubo	Dim. base - altezza	Conf. (pz)	Imballo (pz)	Pallet (pz)	€/pz
1701-1600-01	UT100 300	80x80 mm	B 260x260 H 240 mm	-	1	60	102,830
1701-1400-01	UT200 300	125x125 mm	B 360x360 H 465 mm	-	1	30	155,190
1701-1500-01	UT400 300	125x250 mm	B 360x490 H 465 mm	-	1	24	212,060

## USCITA A TETTO IN PVC

La soluzione giusta per le installazioni che richiedano il passaggio delle tubazioni attraverso il tetto



Cod. europeo	Cod. fabbrica	Dimensioni tubo	Dim. base - altezza	Conf. (pz)	Imballo (pz)	Pallet (pz)	€/pz
1701-2000-01	0508.00007.037	125x125 mm	B 360x360 H 415 mm	-	1	30	61,070
1701-2100-01	0508.00006.037	125x250 mm	B 360x490 H 420 mm	-	1	32	67,170

## CAPPOTTINO

Cappottina che protegge l'unità esterna del condizionatore d'aria dagli agenti atmosferici quando l'unità non è in uso

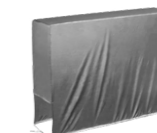

Cod. europeo	Cod. fabbrica	Dimensioni supportate	Conf. (pz)	Imballo (pz)	Pallet (pz)	€/pz
1702-2200-01	9899-080	L760xP560xH2700 mm	-	10	560	27,450
1702-2200-02	9899-081	L800xP600xH300 mm	-	10	560	29,360
1702-2200-03	9899-082	L860xP700xH400 mm	-	10	560	35,350
1702-2200-04	9899-083	L950xP850xH400 mm	-	10	560	37,390

## NASTRO ANTICONDENSA

Nastri anticondensa autoadesivi in gomma sintetica espansa a cellule chiuse. Colore bianco o nero e spessore di 3 mm; Classe di resistenza al fuoco: B-s3, d0 (EN13501)



Cod. europeo	Cod. fabbrica	Lunghezza	Spessore	Larghezza	Conf. (pz)	Imballo (pz)	Pallet (pz)	€/pz
1708-0300-01	0050NAL	50 m	3 µm	50 mm	1	24	864	13,760

# LISTA CODICI

Cod. fabbrica	Cod. europeo	Pag.	Cod. fabbrica	Cod. europeo	Pag.	Cod. fabbrica	Cod. europeo	Pag.
000120	9906-0501-20	82	020410	9902-0104-10	24	021000	9902-0310-02	25
01009	9905-0150-80	89	020415	9902-0104-15	24	022000	9902-0320-00	25
01320	2500-0039-36	130	020502	9902-1105-02	27	025000	9906-1250-00	85
01320	2500-0039-36	89	020505	9902-1205-05	29	025010	9906-1250-10	85
06740	2500-0043-90	61	020506	9902-1205-06	29	025050	9906-1250-50	85
06740	2500-0043-90	93	020507	9902-1205-07	28	025100	9906-1251-00	85
06747	2500-0043-88	93	020508	9902-1205-08	28	025101	9906-1251-01	85
010000	9901-0800-00	16	020509	9902-1205-09	29	025102	9906-1251-02	85
010001	9901-0700-01	16	020513	9902-1105-13	27	025103	9906-1251-03	85
010006	9901-0500-06	17	020515	9902-1105-15	27	025104	9906-1251-04	85
010101	9901-0701-01	16	020520	9902-1205-20	28	025105	9906-1251-05	85
011000	9901-0810-00	16	020533	9902-1105-33	27	025150	9906-1251-50	85
011001	9901-0710-01	16	020537	9902-1105-37	27	030200	9902-0302-00	25
012000	9901-0820-00	16	020550	9902-1205-50	28	030205	9902-0302-05	25
012001	9901-0720-01	16	020600	9902-1106-00	26	030300	9902-0303-00	25
012101	9901-0121-01	16	020700	9902-1507-00	30	030400	9902-0304-00	25
012201	9901-0122-01	16	020701	9902-1507-01	30	031900	9902-0519-00	25
012206	9901-0522-06	17	020705	9902-1507-05	32	032150	9902-0521-50	26
012301	9901-0123-01	16	020706	9902-1507-06	32	032155	9902-0521-55	26
012306	9901-0523-06	17	020708	9902-1507-08	30	032200	9902-0522-00	26
012406	9901-0524-06	17	020710	9902-1507-10	31	070000	9908-5500-00	64
013000	9901-0230-00	17	020711	9902-1507-11	31	070100	9908-5501-00	64
013001	9901-0130-01	17	020715	9902-1507-15	35	071100	9908-5511-00	64
013100	9901-0231-00	17	020720	9902-1507-20	31	072001	9906-0320-01	80
013101	9901-0131-01	17	020722	9902-1507-22	32	072003	9906-0320-03	80
013106	9901-0531-06	17	020723	9902-1507-23	33	072006	9906-0320-06	80
015000	9901-0250-00	18	020728	9902-1507-28	32	072008	9906-0320-08	80
015100	9901-0251-00	18	020729	9902-1507-29	30	072010	9906-0320-10	81
016020	9901-1060-20	18	020731	9902-1507-31	34	072030	9906-0320-30	81
018000	9901-2080-00	19	020732	9902-1507-32	35	072031	9906-0320-31	81
018001	9901-2080-01	19	020733	9902-1507-33	34	072090	9906-0320-90	81
018006	9901-2080-06	19	020734	9902-1507-34	33	072100	9906-0321-00	81
018008	9901-2080-08	19	020735	9902-1507-35	33	073000	9908-5030-00	63
018011	9901-2080-11	19	020736	9902-1507-36	33	073005	9908-5330-05	144
020201	9902-0102-01	24	020737	9902-1507-37	34	073010	9908-5030-10	63
020205	9902-0102-05	24	020738	9902-1507-38	35	073015	9908-5330-15	144
020400	9902-0104-00	24	020739	9902-1507-39	35	073020	9908-5030-20	63
020405	9902-0104-05	24	020740	9902-1507-40	31	073022	9908-5030-22	63

Cod. fabbrica	Cod. europeo	Pag.	Cod. fabbrica	Cod. europeo	Pag.	Cod. fabbrica	Cod. europeo	Pag.
073025	9908-5330-25	144	080804	9908-1308-04	46	082510	9908-2225-10	142
073030	9908-5030-30	63	080853	9908-1108-53	45	082519	9908-2325-19	143
073032	9908-5030-32	63	080903	9908-1109-03	45	082550	9908-1225-50	46
073035	9908-5330-35	144	080904	9908-1309-04	46	082559	9908-1625-59	49
073040	9908-5030-40	63	081000	9908-3110-00	54	082560	9908-2225-60	142
073045	9908-5330-45	144	081010	9908-3110-10	54	082569	9908-2325-69	143
073050	9908-5030-50	63	081015	9908-3110-15	54	082600	9908-1226-00	46
073055	9908-5330-55	144	081020	9908-3110-20	54	082609	9908-1626-09	49
073060	9908-5030-60	63	081025	9908-3110-25	54	082610	9908-2226-10	142
073065	9908-5330-65	144	081030	9908-3110-30	54	082619	9908-2326-19	143
073070	9908-5030-70	63	081035	9908-3110-35	54	082700	9908-1227-00	46
073075	9908-5330-75	144	081040	9908-3110-40	54	082709	9908-1627-09	49
073080	9908-5030-80	63	081045	9908-3110-45	54	082710	9908-2227-10	142
073085	9908-5330-85	144	081050	9908-3110-50	54	082719	9908-2327-19	143
073095	9908-5330-95	144	081055	9908-3110-55	54	082800	9908-1228-00	46
073105	9908-5331-05	144	081060	9908-3110-60	54	082809	9908-1628-09	49
073115	9908-5331-15	144	081065	9908-3110-65	54	082810	9908-2228-10	142
074000	9906-0540-00	82	081070	9908-3110-70	54	082819	9908-2328-19	143
074010	9906-0540-10	82	081080	9908-3110-80	54	082850	9908-1228-50	46
074012	9906-0540-12	82	081085	9908-3110-85	54	082859	9908-1628-59	49
074030	9906-0540-30	82	082000	9908-1220-00	46	082860	9908-2228-60	142
075510	9999-0755-10	80	082009	9908-1620-09	49	082869	9908-2328-69	143
075520	9999-0755-20	80	082010	9908-2220-10	142	082900	9908-1229-00	46
075525	9999-0755-25	80	082019	9908-2320-19	143	082909	9908-1629-09	49
075530	9999-0755-30	80	082100	9908-1221-00	46	082910	9908-2229-10	142
080003	9908-1100-03	45	082109	9908-1621-09	49	082919	9908-2329-19	143
080004	9908-1300-04	46	082110	9908-2221-10	142	082930	9908-1229-30	46
080103	9908-1101-03	45	082119	9908-2321-19	143	082931	9908-2229-31	142
080104	9908-1301-04	46	082200	9908-1222-00	46	082932	9908-2229-32	142
080203	9908-1102-03	45	082209	9908-1622-09	49	082939	9908-1629-39	49
080204	9908-1302-04	46	082210	9908-2222-10	142	082950	9908-1229-50	46
080303	9908-1103-03	45	082219	9908-2322-19	143	082951	9908-2229-51	142
080304	9908-1303-04	46	082300	9908-1223-00	46	082952	9908-2229-52	142
080403	9908-1104-03	45	082309	9908-1623-09	49	082959	9908-1629-59	49
080404	9908-1304-04	46	082310	9908-2223-10	142	082969	9908-1629-69	49
080503	9908-1105-03	45	082319	9908-2323-19	143	082970	9908-1229-70	46
080504	9908-1305-04	46	082400	9908-1224-00	46	082979	9908-1629-79	49
080603	9908-1106-03	45	082409	9908-1624-09	49	082990	9908-1229-90	46
080604	9908-1306-04	46	082410	9908-2224-10	142	082999	9908-1629-99	49
080703	9908-1107-03	45	082419	9908-2324-19	143	083000	9908-2730-00	47
080704	9908-1307-04	46	082500	9908-1225-00	46	083100	9908-2731-00	47
080803	9908-1108-03	45	082509	9908-1625-09	49	083200	9908-2732-00	47

Cod. fabbrica	Cod. europeo	Pag.	Cod. fabbrica	Cod. europeo	Pag.	Cod. fabbrica	Cod. europeo	Pag.	Cod. fabbrica	Cod. europeo	Pag.	Cod. fabbrica	Cod. europeo	Pag.	Cod. fabbrica	Cod. europeo	Pag.
083300	9908-2733-00	47	084901	9908-3749-01	126	086000	9908-1860-00	51	090070	9908-0100-70	60	100260	9904-0102-12	96	130131	9904-0201-31	98
083400	9908-2734-00	47	084930	9908-3549-30	48	086010	9908-1860-10	51	090090	9908-0100-90	60	100325	9904-0103-05	98	130134	9904-0201-34	98
083500	9908-2735-00	47	084931	9908-3749-31	49	086020	9908-1860-20	51	090130	9908-0101-30	60	100330	9904-0103-06	98	130162	9904-0201-62	99
083600	9908-2736-00	47	084931	9908-3749-31	126	086030	9908-1860-30	51	090150	9908-0101-50	60	102001	9903-0306-01	90	130162	9904-0201-62	130
083700	9908-2737-00	47	084950	9908-3549-50	48	086040	9908-1860-40	51	090160	9908-0101-60	60	104001	9903-0308-01	90	130164	9904-0201-64	99
083800	9908-2738-00	47	084951	9908-3749-51	49	086050	9908-1860-50	51	090170	9908-0101-70	60	106201	9903-0310-01	90	130164	9904-0201-64	130
083900	9908-2739-00	47	084951	9908-3749-51	126	086060	9908-1860-60	51	090500	9908-0405-00	62	108201	9903-0312-01	90	130172	9904-0201-72	99
083910	9908-2739-10	47	084970	9908-3549-70	48	086070	9908-1860-70	51	090510	9908-0405-10	62	120010	9903-0500-10	96	130172	9904-0201-72	130
083915	9908-2739-15	47	084971	9908-3749-71	49	086080	9908-1860-80	51	090520	9908-0405-20	62	120012	9903-0500-12	96	130174	9904-0201-74	99
083920	9908-2739-20	47	084971	9908-3749-71	126	086090	9908-1860-90	51	090530	9908-0405-30	62	120050	9903-0500-50	95	130174	9904-0201-74	130
083925	9908-2739-25	47	085000	9908-4050-00	55	086100	9908-1861-00	51	090540	9908-0405-40	62	120055	9903-0500-55	95	130182	9904-0201-82	99
083930	9908-2739-30	47	085001	9908-4150-01	56	086200	9908-1762-00	50	090560	9908-0405-60	62	120100	9903-0501-00	95	130182	9904-0201-82	130
083935	9908-2739-35	47	085100	9908-4051-00	55	086210	9908-1762-10	50	090570	9908-0405-70	62	120140	9903-0501-40	95	130184	9904-0201-84	99
083940	9908-2739-40	47	085101	9908-4151-01	56	086220	9908-1762-20	50	090610	9908-0406-10	62	120180	9903-0501-80	95	130184	9904-0201-84	130
083945	9908-2739-45	47	085200	9908-4052-00	55	086230	9908-1762-30	50	090620	9908-0406-20	62	120220	9903-0502-20	95	130280	9904-0105-01	99
083955	9908-2739-55	47	085201	9908-4152-01	56	086240	9908-1762-40	50	090630	9908-0406-30	62	120225	9903-0502-25	95	130290	9904-0105-10	99
083960	9908-2739-60	47	085300	9908-4053-00	55	086250	9908-1762-50	50	090640	9908-0406-40	62	120310	9903-0603-10	94	130310	9904-0105-02	99
084012	9908-2140-12	142	085301	9908-4153-01	56	086255	9908-1762-55	50	090660	9908-0406-60	62	120320	9903-0603-20	94	130320	9904-0105-11	99
084015	9908-2140-15	142	085309	9908-4353-09	51	086260	9908-1762-60	50	091030	9908-0210-30	60	120350	9903-0603-50	95	130330	9904-0105-21	99
084018	9908-2140-18	142	085400	9908-4054-00	55	086270	9908-1762-70	50	091040	9908-0210-40	60	122201	9901-0122-06	18	131210	9904-0111-04	100
084022	9908-2140-22	142	085401	9908-4154-01	56	086280	9908-1762-80	50	091060	9908-0210-60	60	130000	9904-0110-00	129	131230	9904-0111-06	100
084028	9908-2140-28	142	085409	9908-4354-09	51	086285	9908-1762-85	50	091070	9908-0210-70	60	130000	9904-0110-00	97	131235	9904-0111-07	100
084300	9908-3543-00	48	085500	9908-4055-00	55	086290	9908-1762-90	50	091090	9908-0210-90	60	130001	9904-0110-01	97	131240	9904-0111-08	100
084301	9908-3743-01	126	085501	9908-4155-01	56	086293	9908-1762-93	50	091130	9908-0211-30	60	130001	9904-0110-01	129	131250	9904-0111-09	100
084301	9908-3743-01	49	085509	9908-4355-09	51	086295	9908-1762-95	50	091150	9908-0211-50	60	130002	9904-0110-02	97	131810	9903-0118-10	93
084400	9908-3544-00	48	085600	9908-4056-00	55	087075	9908-4570-75	50	092010	9908-0520-10	62	130002	9904-0110-02	129	131811	9903-0118-11	100
084401	9908-3744-01	49	085601	9908-4156-01	56	087090	9908-4570-90	50	092020	9908-0520-20	62	130005	9904-0110-05	97	131830	9903-0118-30	93
084401	9908-3744-01	126	085609	9908-4356-09	51	087110	9908-4571-10	50	092030	9908-0520-30	62	130005	9904-0110-05	129	131831	9903-0118-31	100
084500	9908-3545-00	48	085650	9908-4056-50	55	087125	9908-4571-25	50	092040	9908-0520-40	62	130010	9904-0110-10	97	131835	9903-0118-35	93
084501	9908-3745-01	49	085651	9908-4156-51	56	087135	9908-4571-35	50	092090	9908-0520-90	63	130020	9904-0110-20	97	131850	9903-0118-50	93
084501	9908-3745-01	126	085700	9908-4057-00	55	087160	9908-4571-60	50	092095	9908-0520-95	63	130051	9904-0110-51	98	131855	9903-0118-55	93
084600	9908-3546-00	48	085701	9908-4157-01	56	088000	9908-9780-00	57	093003	9908-0630-03	61	130051	9904-0110-51	130	131860	9903-0118-60	94
084601	9908-3746-01	49	085709	9908-4357-09	51	089000	9908-9990-00	57	093004	9908-0630-04	61	130053	9904-0110-53	98	131860	9903-0118-60	59
084601	9908-3746-01	126	085801	9908-4158-01	56	089005	9908-9990-05	57	093005	9908-0630-05	61	130053	9904-0110-53	130	131865	9903-0118-65	59
084700	9908-3547-00	48	085802	9908-4058-02	55	089450	9908-9794-50	58	099000	9908-0290-00	59	130055	9904-0110-55	98	131865	9903-0118-65	94
084701	9908-3747-01	49	085821	9908-4158-21	56	089460	9908-9794-60	58	099010	9908-0290-10	60	130055	9904-0110-55	130	131875	9903-0118-75	93
084701	9908-3747-01	126	085851	9908-4158-51	56	089470	9908-9794-70	58	100100	9904-0101-00	96	130057	9904-0110-57	98	131900	9903-0119-00	92
084800	9908-3548-00	48	085852	9908-4058-52	55	089480	9908-9794-80	58	100110	9904-0101-01	96	130057	9904-0110-57	130	131901	9903-0119-01	92
084801	9908-3748-01	49	085901	9908-4159-01	56	089511	9908-2295-11	144	100120	9904-0101-02	96	130111	9904-0201-11	98	134000	9903-0306-11	91
084801	9908-3748-01	126	085902	9908-4059-02	55	090030	9908-0100-30	60	100130	9904-0101-03	96	130114	9904-0201-14	98	134200	9903-0306-13	92
084900	9908-3549-00	48	085951	9908-4159-51	56	090040	9908-0100-40	60	100250	9904-0102-10	96	130121	9904-0201-21	98	134400	9903-0306-15	91
084901	9908-3749-01	49	085952	9908-4059-52	55	090060	9908-0100-60	60	100255	9904-0102-11	96	130124	9904-0201-24	98	138000	9903-0308-11	91

Cod. fabbrica	Cod. europeo	Pag.	Cod. fabbrica	Cod. europeo	Pag.	Cod. fabbrica	Cod. europeo	Pag.	Cod. fabbrica	Cod. europeo	Pag.	Cod. fabbrica	Cod. europeo	Pag.	Cod. fabbrica	Cod. europeo	Pag.
138200	9903-0308-13	92	160158	9909-5001-58	133	161208	9909-3612-08	115	161756	9909-4517-56	128	162332	9909-4023-32	119	164000	9909-0840-00	109
138400	9903-0308-15	91	160200	9909-0102-00	106	161209	9909-3612-09	116	161757	9909-4517-57	128	162340	9909-4023-40	118	164010	9909-2740-10	151
138410	9903-0308-16	91	160302	9909-3003-02	114	161210	9909-4212-10	116	161901	9909-0619-01	108	162342	9909-4023-42	118	164101	9909-4441-01	120
138700	9903-0308-19	91	160305	9909-3003-05	114	161215	9909-3612-15	115	161902	9909-0619-02	108	162350	9909-4023-50	118	164102	9909-0841-02	109
142700	9903-0310-11	91	160306	9909-3003-06	114	161216	9909-2612-16	149	161920	9909-0619-20	108	162352	9909-4023-52	118	164110	9909-2741-10	151
146400	9903-0310-12	94	160350	9909-5003-50	133	161220	9909-0312-20	106	161922	9909-0619-22	108	162400	9909-5024-00	111	164200	9909-0842-00	109
146400	9903-0310-12	59	160350	9909-5003-50	156	161221	9909-2612-21	147	161930	9909-0619-30	108	162500	9909-0825-00	110	164201	9909-4442-01	120
146401	9903-0310-13	59	160350	9909-5003-50	156	161225	9999-1612-25	106	161932	9909-0619-32	108	162510	9909-2725-10	152	164210	9909-2742-10	151
146401	9903-0310-13	94	160400	9909-3004-00	114	161228	9909-3312-28	115	161950	9909-3519-50	117	162600	9909-0826-00	110	164210	9909-2742-10	156
146405	9904-1664-05	145	160450	9909-5004-50	133	161229	9909-3312-29	115	161951	9909-2719-51	149	162610	9909-2726-10	152	164210	9909-2742-10	156
146500	9903-0312-11	59	160600	9909-3006-00	114	161230	9909-3312-30	115	161960	9909-3519-60	117	162700	9909-0827-00	110	164210	9909-2742-10	157
146500	9903-0312-11	94	160800	9909-3008-00	114	161233	9909-3312-33	115	161962	9909-3519-62	117	162710	9909-2727-10	157	164210	9909-2742-10	157
146501	9903-0312-12	59	161001	9909-1110-01	111	161235	9909-3312-35	115	161963	9909-2719-63	150	162710	9909-2727-10	157	164250	9909-0842-50	109
146501	9903-0312-12	94	161005	9909-2710-05	148	161255	9909-0412-55	107	161965	9909-3519-65	117	162710	9909-2727-10	156	164251	9909-2742-51	151
146505	9904-1665-05	145	161011	9909-1110-11	111	161256	9909-0412-56	107	161966	9909-2719-66	150	162710	9909-2727-10	156	164270	9909-0842-70	120
146510	9903-0312-13	59	161020	9909-4210-20	123	161265	9909-0412-65	107	161968	9909-3519-68	117	162710	9909-2727-10	152	164271	9909-0842-71	120
146510	9903-0312-13	94	161021	9909-4210-21	123	161266	9909-0412-66	107	161970	9909-3519-70	117	162750	9909-0827-50	110	164272	9909-0842-72	120
146700	9903-0312-14	91	161030	9909-3710-30	120	161270	9909-0412-70	108	161972	9909-3519-72	117	162751	9909-2727-51	152	164273	9909-0842-73	120
155025	9905-0150-25	90	161033	9909-3710-33	120	161282	9909-2612-82	147	161973	9909-2719-73	150	162800	9909-0828-00	110	164500	9909-5045-00	110
155030	9905-0150-30	90	161035	9909-3710-35	121	161285	9909-2612-85	147	161975	9909-3519-75	117	162801	9909-0828-01	110	164503	9909-5045-03	110
155034	9905-0150-34	90	161036	9909-2710-36	148	161300	9909-0313-00	111	161976	9909-2719-76	150	162802	9909-0828-02	110	164505	9909-2745-05	151
155040	9905-0150-40	90	161040	9909-3710-40	121	161350	9909-3613-50	117	161978	9909-3519-78	117	162803	9909-0828-03	110	164511	9909-5045-11	110
155065	9905-0150-65	90	161044	9909-3710-44	121	161400	9909-4214-00	122	161980	9909-3519-80	118	163200	9909-5032-00	109	164513	9909-5045-13	110
155067	9905-0150-67	90	161048	9909-3710-48	121	161410	9909-4214-10	122	161985	9909-3519-85	118	163201	9909-2732-01	152	164520	9909-4445-20	119
155069	9905-0150-69	90	161050	9909-3710-50	122	161420	9909-4214-20	122	161990	9909-3519-90	118	163210	9906-0932-10	83	164690	9904-1546-90	92
155085	9905-0150-85	89	161052	9909-3710-52	120	161430	9909-4214-30	122	161991	9909-3519-91	118	163211	9909-2732-11	145	164700	9904-1547-00	92
155086	9905-0150-86	89	161056	9909-3710-56	121	161450	9909-3614-50	122	161992	9909-3519-92	118	163250	9906-0932-50	84	164701	9904-1547-01	92
155088	9905-0150-88	89	161058	9909-3710-58	116	161490	9909-4214-90	123	162001	9909-0720-01	109	163300	9909-5033-00	109	164702	9904-1547-02	92
155199	9905-1951-99	88	161060	9909-3710-60	128	161540	9909-4215-40	123	162060	9909-3920-60	119	163301	9909-2733-01	152	164706	9904-1647-06	145
155200	9905-1952-00	88	161060	9909-3710-60	116	161550	9909-3615-50	122	162101	9909-0721-01	109	163305	9909-5033-05	109	164710	9904-1547-10	92
155220	9905-1952-20	88	161062	9909-3710-62	116	161600	9909-4216-00	123	162110	9909-2721-10	148	163310	9906-0933-10	83	164711	9904-1547-11	92
155240	9905-1952-40	88	161062	9909-3710-62	128	161610	9909-4216-10	123	162120	9909-3921-20	119	163311	9909-2733-11	145	164712	9904-1547-12	92
155260	9905-1952-60	88	161101	9909-1111-01	111	161611	9909-4216-11	123	162201	9909-0722-01	109	163320	9909-5033-20	134	164713	9904-1547-13	92
155280	9905-1952-80	88	161105	9909-2711-05	148	161700	9909-5017-00	133	162210	9909-2722-10	148	163500	9909-5035-00	109	164716	9904-1647-16	145
155500	9905-1955-00	88	161111	9909-1111-11	111	161710	9909-5017-10	133	162220	9909-3922-20	119	163501	9909-2735-01	152	164720	9908-0147-20	61
160006	9909-0100-06	106	161121	9909-4211-21	123	161750	9909-5017-50	129	162222	9909-4522-22	128	163505	9909-5035-05	109	164725	9908-0247-25	61
160010	9909-2500-10	146	161190	9909-4211-90	124	161750	9909-5017-50	132	162290	9909-0922-90	110	163510	9906-0935-10	83	164727	9908-0247-27	61
160050	9909-5000-50	133	161190	9909-4211-90	129	161751	9909-4517-51	126	162300	9909-0923-00	110	163511	9909-2735-11	145	165000	9909-5050-00	134
160106	9909-0101-06	106	161200	9909-0312-00	107	161752	9909-4517-52	126	162310	9909-0923-10	110	163520	9909-5035-20	134	165005	9909-5050-05	134
160108	9909-0101-08	106	161201	9909-2612-01	147	161753	9909-4517-53	127	162320	9909-3923-20	119	163605	9909-5036-05	109	165010	9909-5050-10	134
160110	9909-2501-10	146	161202	9909-0312-02	107	161754	9909-4517-54	127	162330	9909-4023-30	119	163610	9906-0936-10	83	165501	9909-4855-01	132
160150	9909-5001-50	133	161205	9909-3312-05	116	161755	9909-4517-55	127	162331	9909-4023-31	119	163611	9909-2736-11	145	165502	9909-4855-02	132

Cod. fabbrica	Cod. europeo	Pag.	Cod. fabbrica	Cod. europeo	Pag.	Cod. fabbrica	Cod. europeo	Pag.	Cod. fabbrica	Cod. europeo	Pag.	Cod. fabbrica	Cod. europeo	Pag.	Cod. fabbrica	Cod. europeo	Pag.
165503	9909-4855-03	132	168400	9908-2884-00	48	180335	9908-7103-35	41	181055	9908-7510-55	44	270301	9906-2003-01	146	700266	9910-3002-66	148
165520	9909-4855-20	132	168410	9908-2984-10	143	180340	9908-7103-40	41	181060	9908-7510-60	44	271050	9906-1910-50	84	700275	9910-3002-75	151
165550	9909-4855-50	132	168600	9908-2886-00	48	180405	9999-1804-05	42	181070	9908-7510-70	45	271051	9906-2010-51	146	700280	9910-3002-80	150
165700	9909-4957-00	135	168610	9908-2986-10	143	180410	9999-1804-10	42	181100	9999-1811-00	45	272001	9906-2020-01	146	700310	9910-3503-10	149
165701	9909-4957-01	135	168800	9908-2888-00	48	180415	9999-1804-15	42	230000	9901-1000-00	18	272060	9906-1920-60	84	700320	9910-3503-20	149
165702	9909-4957-02	135	168810	9908-2988-10	143	180420	9999-1804-20	42	230010	9901-1000-10	18	300110	9903-0901-10	102	700345	9910-3503-45	156
165703	9909-4957-03	135	169000	9908-2890-00	48	180425	9999-1804-25	42	260010	9901-2900-10	20	300120	9903-0901-20	102	700345	9910-3503-45	156
165720	9909-4957-20	135	169010	9908-2990-10	143	180430	9999-1804-30	42	260015	9901-2900-15	20	302001	9903-0920-01	100	700345	9910-3503-45	149
165721	9909-4957-21	135	169100	9908-2891-00	48	180435	9999-1804-35	42	260016	9901-2900-16	20	304001	9903-0940-01	100	700362	9910-3503-62	158
165730	9909-4957-30	135	169200	9908-2892-00	48	180440	9999-1804-40	42	260030	9901-2900-30	20	306201	9903-0962-01	100	700367	9910-3503-67	158
165731	9909-4957-31	135	169300	9908-2893-00	48	180445	9999-1804-45	42	261000	9906-1910-00	83	308201	9903-0982-01	100	700370	9910-3503-70	151
165732	9909-4957-32	135	180005	9908-7000-05	40	180505	9908-7305-05	43	261210	9904-0112-10	97	330112	9903-0901-12	102	700376	9910-3503-76	157
165750	9909-4957-50	136	180010	9908-7000-10	40	180510	9908-7305-10	43	261220	9904-0112-20	97	330122	9903-0901-22	102	700376	9910-3503-76	157
165751	9909-4957-51	136	180015	9908-7000-15	40	180515	9908-7305-15	43	261230	9904-0112-30	97	330123	9903-0901-23	102	700376	9910-3503-76	151
165752	9909-4957-52	136	180020	9908-7000-20	40	180520	9908-7305-20	43	262600	9908-9726-00	58	332000	9903-0905-00	101	700385	9910-3503-85	158
165753	9909-4957-53	136	180025	9908-7000-25	40	180525	9908-7305-25	43	262601	9908-9726-01	58	334000	9903-0906-00	101	700500	9910-3805-00	156
165760	9909-4957-60	136	180030	9908-7000-30	40	180530	9908-7305-30	43	262700	9908-9727-00	58	334400	9903-0906-01	101	700500	9910-3805-00	157
165761	9909-4957-61	136	180035	9908-7000-35	40	180535	9908-7305-35	43	262701	9908-9727-01	58	338000	9903-0908-00	101	700500	9910-3805-00	159
165762	9909-4957-62	136	180040	9908-7000-40	40	180605	9908-7306-05	43	262800	9908-9728-00	58	338200	9903-0908-01	102	700520	9910-3805-20	156
165763	9909-4957-63	136	180045	9908-7000-45	40	180610	9908-7306-10	43	262900	9908-9729-00	58	338400	9903-0908-02	101	700520	9910-3805-20	157
166000	9908-9960-00	57	180105	9999-1801-05	40	180615	9908-7306-15	43	262901	9908-9729-01	58	338410	9903-0908-03	101	700520	9910-3805-20	159
166001	9908-9960-01	57	180110	9999-1801-10	40	180620	9908-7306-20	43	262902	9908-9729-02	58	338700	9903-0908-04	101	700525	9910-3805-25	156
166040	9908-9960-40	57	180115	9999-1801-15	40	180625	9908-7306-25	43	264900	9906-0749-00	83	338710	9903-0908-05	101	700525	9910-3805-25	157
166050	9908-9960-50	57	180120	9999-1801-20	40	180630	9908-7306-30	43	264910	9906-0849-10	145	342700	9903-0910-00	101	700525	9910-3805-25	159
166051	9908-9960-51	57	180125	9999-1801-25	40	180635	9908-7306-35	43	265000	9906-0750-00	83	346700	9903-0912-00	101	700610	9910-3906-10	159
166200	9908-9962-00	57	180130	9999-1801-30	40	180640	9908-7306-40	43	265002	9906-0750-02	83	700010	9910-1000-10	156	700612	9910-3906-12	159
166500	9909-5065-00	135	180135	9999-1801-35	40	180705	9908-7207-05	42	265010	9906-0850-10	145	700015	9910-1000-15	156	700620	9910-3906-20	160
166900	9909-5069-00	56	180140	9999-1801-40	40	180710	9908-7207-10	42	265100	9906-0751-00	83	700030	9910-1000-30	157	700630	9910-3906-30	160
167000	9908-2870-00	48	180145	9999-1801-45	40	180715	9908-7207-15	42	265102	9906-0751-02	83	700035	9910-1000-35	157	700652	9910-3906-52	160
167010	9908-2970-10	143	180205	9908-7102-05	41	180720	9908-7207-20	42	265110	9906-0851-10	145	700209	9909-2502-09	147	700657	9910-3906-57	160
167200	9908-2872-00	48	180210	9908-7102-10	41	180725	9908-7207-25	42	265200	9906-0752-00	83	700210	9909-2502-10	147	700660	9910-3906-60	160
167210	9908-2972-10	143	180215	9908-7102-15	41	180730	9908-7207-30	42	265210	9906-0852-10	145	700239	9910-2002-39	156	700665	9910-3906-65	160
167400	9908-2874-00	48	180220	9908-7102-20	41	180735	9908-7207-35	42	265300	9906-0753-00	83	700239	9910-2002-39	156	0515.00114.072	1101-2411-01	173
167410	9908-2974-10	143	180225	9908-7102-25	41	180740	9908-7207-40	42	265400	9906-0754-00	83	700239	9910-2002-39	157	0515.00214.072	1101-2414-01	173
167600	9908-2876-00	48	180230	9908-7102-30	41	180745	9908-7207-45	42	265500	9906-0755-00	83	700239	9910-2002-39	157	01005G	9905-0150-75	89
167610	9908-2976-10	143	180235	9908-7102-35	41	180845	9999-1808-45	44	265600	9906-0756-00	83	700239	9910-2002-39	158	0304GC	1101-0404-01	175
167800	9908-2878-00	48	180305	9908-7103-05	41	180850	9999-1808-50	44	266000	9906-0760-00	83	700240	9910-2002-40	158	0304GC-W	1101-0404-02	175
167810	9908-2978-10	143	180310	9908-7103-10	41	180855	9999-1808-55	44	269000	9901-0890-00	20	700241	9910-2002-41	158	0305AI	1101-0504-01	174
168000	9908-2880-00	48	180315	9908-7103-15	41	180945	9908-7409-45	44	269001	9901-0890-01	20	700255	9910-3002-55	150	0305AI-W	1101-0504-02	174
168010	9908-2980-10	143	180320	9908-7103-20	41	180950	9908-7409-50	44	269002	9901-0890-02	20	700257	9910-3002-57	158	0306AE	1101-0604-01	175
168200	9908-2882-00	48	180325	9908-7103-25	41	180955	9908-7409-55	44	270200	9906-1902-00	84	700260	9910-3002-60	148	0306AE-W	1101-0604-02	175
168210	9908-2982-10	143	180330	9908-7103-30	41	181050	9908-7510-50	44	270300	9906-1903-00	84	700263	9910-3002-63	148	0307CP	1101-0704-01	174

Cod. fabbrica	Cod. europeo	Pag.	Cod. fabbrica	Cod. europeo	Pag.	Cod. fabbrica	Cod. europeo	Pag.	Cod. fabbrica	Cod. europeo	Pag.	Cod. fabbrica	Cod. europeo	Pag.	Cod. fabbrica	Cod. europeo	Pag.
0307CP-W	1101-0704-02	174	0615VD-W	1101-1606-02	172	0807CP-G	1101-0711-04	166	0903ST	1101-0312-01	166	1224KC	1101-2514-01	173	9801-112-08	1102-0507-01	180
0308TT	1101-0804-01	175	0620IR	1101-2106-01	172	0807CP-M	1101-0711-05	166	0904GC	1101-0412-01	169	1280RI	1101-1414-01	170	9801-113-08	1102-0607-01	181
0308TT-W	1101-0804-02	175	0620IR-W	1101-2106-02	172	0807CP-W	1101-0711-02	166	0904GC-W	1101-0412-02	169	1280RI-W	1101-1414-02	170	9801-114-08	1102-0807-01	181
0310RC	1101-2604-01	176	0621ER	1101-2206-01	172	0808TT	1101-0811-01	168	0905AI-W	1101-0512-02	167	1290RI	1101-1414-03	170	9801-115-08	1102-0707-01	181
0310RC-W	1101-2604-02	176	0621ER-W	1101-2206-02	172	0808TT-B	1101-0811-03	168	0905IA	1101-0512-01	167	1290RI-W	1101-1414-04	170	9801-116-08	1102-0907-01	182
0312BC	1101-0104-01	174	0622PR	1101-2306-01	171	0808TT-G	1101-0811-04	168	0906AE-W	1101-0612-02	168	1403ST	1101-0316-01	166	9801-117-08	1102-2307-01	183
0312BC-W	1101-0104-02	174	0622PR-W	1101-2306-02	171	0808TT-M	1101-0811-05	168	0906EA	1101-0612-01	168	1404GC	1101-0416-01	169	9801-200-08	1102-1307-01	183
0404GC	1101-0405-01	175	0703ST	1101-0308-01	166	0808TT-W	1101-0811-02	168	0907CP	1101-0712-01	166	1404GC-W	1101-0416-02	169	9801-202-08	1102-1107-01	182
0404GC-W	1101-0405-02	175	0704GC	1101-0408-01	169	0809CM	1101-0911-01	167	0907CP-W	1101-0712-02	166	1405AI-W	1101-0516-02	167	9802-001-08	1102-0112-01	178
0405AI	1101-0505-01	174	0704GC-W	1101-0408-02	169	0809CM-B	1101-0911-03	167	0908TT	1101-0812-01	168	1405IA	1101-0516-01	167	9802-001-08F	1102-0112-02	178
0405AI-W	1101-0505-02	174	0705AI-W	1101-0508-02	167	0809CM-G	1101-0911-04	167	0908TT-W	1101-0812-02	168	1406AE-W	1101-0616-02	168	9802-101-00	1102-0312-01	180
0406AE	1101-0605-01	175	0705IA	1101-0508-01	167	0809CM-M	1101-0911-05	167	0909CM	1101-0912-01	167	1406EA	1101-0616-01	168	9802-102-08	1102-0412-01	180
0406AE-W	1101-0605-02	175	0706AE-W	1101-0608-02	168	0809CM-W	1101-0911-02	167	0909CM-W	1101-0912-02	167	1407CP	1101-0716-01	166	9802-111-08	1102-1012-01	182
0407CP	1101-0705-01	174	0706EA	1101-0608-01	168	0810PM	1101-1011-01	169	0910PM	1101-1012-01	169	1407CP-W	1101-0716-02	166	9802-112-08	1102-0512-01	180
0407CP-W	1101-0705-02	174	0707CP	1101-0708-01	166	0810PM-B	1101-1011-03	169	0910PM-W	1101-1012-02	169	1409CM	1101-0916-01	167	9802-113-08	1102-0612-01	181
0408TT	1101-0905-01	175	0707CP-W	1101-0708-02	166	0810PM-G	1101-1011-04	169	0912BCF	1101-0112-01	164	1409CM-W	1101-0916-02	167	9802-114-08	1102-0812-01	181
0408TT-W	1101-0905-02	175	0708TT	1101-0808-01	168	0810PM-M	1101-1011-05	169	0912BCF-W	1101-0112-02	164	1410PM	1101-1016-01	169	9802-115-08	1102-0712-01	181
0410RC	1101-2605-01	176	0708TT-W	1101-0808-02	168	0810PM-W	1101-1011-02	169	0913 DT	1101-1312-01	171	1410PM-W	1101-1016-02	169	9802-116-08	1102-0912-01	182
0410RC-W	1101-2605-02	176	0709CM	1101-0908-01	167	0811GF	1101-1111-01	173	0913 DT-W	1101-1312-02	171	1412BCF	1101-0116-01	164	9802-117-08	1102-2312-01	183
0412BC	1101-0105-01	174	0709CM-W	1101-0908-02	167	0811GF-W	1101-1111-02	173	0916RM	1101-1712-01	170	1412BCF-W	1101-0116-02	164	9802-117-08	1102-2315-01	183
0412BC-W	1101-0105-02	174	0710PM	1101-1008-01	169	0812BCF	1101-0111-01	164	0916RM-W	1101-1712-02	170	1412RI	1101-1416-01	170	9802-200-08	1102-1312-01	183
0603ST	1101-0306-01	166	0710PM-W	1101-1008-02	169	0812BCF-B	1101-0111-03	165	1203ST	1101-0314-01	166	1412RI-W	1101-1416-02	170	9802-201-08	1102-1412-01	183
0604GC	1101-0406-01	169	0712BCF	1101-0108-01	164	0812BCF-G	1101-0111-04	165	1204GC	1101-0414-01	169	1413DT	1101-1316-01	171	9802-202-08	1102-1112-01	182
0604GC-W	1101-0406-02	169	0712BCF-W	1101-0108-02	164	0812BCF-M	1101-0111-05	165	1204GC-W	1101-0414-02	169	1413DT-W	1101-1316-02	171	9803-001-08	1102-0115-01	178
0605AI-W	1101-0506-02	167	0803ST	1101-0310-01	166	0812BCF-W	1101-0111-02	164	1205AI-W	1101-0514-02	167	1818CE	1111-0102-01	174	9803-001-08F	1102-0115-02	178
0605IA	1101-0506-01	167	0804GC	1101-0411-01	169	0813 DT	1101-1311-01	171	1205IA	1101-0514-01	167	51124P	2500-0039-35	89	9803-101-00	1102-0315-01	180
0606AE-W	1101-0606-02	168	0804GC-B	1101-0411-03	169	0813 DT-B	1101-1311-03	171	1206AE-W	1101-0614-02	168	8060RI	1101-1411-01	170	9803-102-08	1102-0415-01	180
0606EA	1101-0606-01	168	0804GC-G	1101-0411-04	169	0813 DT-G	1101-1311-04	171	1206EA	1101-0614-01	168	8060RI-W	1101-1411-02	170	9803-111-08	1102-1015-01	182
0607CP	1101-0706-01	166	0804GC-M	1101-0411-05	169	0813 DT-M	1101-1311-05	171	1207CP	1101-0714-01	166	8070 RI	1101-1411-03	170	9803-112-08	1102-0515-01	180
0607CP-W	1101-0706-02	166	0804GC-W	1101-0411-02	169	0813 DT-W	1101-1311-02	171	1207CP-W	1101-0714-02	166	8070 RI-W	1101-1411-04	170	9803-113-08	1102-0615-01	181
0608TT	1101-0806-01	168	0805AI-B	1101-0511-03	167	0814VS	1101-1511-01	172	1208TT	1101-0814-01	168	9060 RI	1101-1412-01	170	9803-114-08	1102-0815-01	181
0608TT-W	1101-0806-02	168	0805AI-G	1101-0511-04	167	0814VS-W	1101-1511-02	172	1208TT-W	1101-0814-02	168	9060 RI-W	1101-1412-02	170	9803-115-08	1102-0715-01	181
0609CM	1101-0906-01	167	0805AI-M	1101-0511-05	167	0815VD	1101-1611-01	172	1209CM	1101-0914-01	167	9070 RI	1101-1412-03	170	9803-116-08	1102-0915-01	182
0609CM-W	1101-0906-02	167	0805AI-W	1101-0511-02	167	0815VD-W	1101-1611-02	172	1209CM-W	1101-0914-02	167	9070 RI-W	1101-1412-04	170	9803-200-08	1102-1315-01	183
0610PM	1101-1006-01	169	0805IA	1101-0511-01	167	0816RM	1101-1711-01	170	1210PM	1101-1014-01	169	9795-131-700	9902-1508-01	36	9803-201-08	1102-1415-01	183
0610PM-W	1101-1006-02	169	0806AE-B	1101-0611-03	168	0816RM-W	1101-1711-02	170	1210PM-W	1101-1014-02	169	9795-141-700	9902-1508-10	36	9803-202-08	1102-1115-01	182
0611GF	1101-1106-01	173	0806AE-G	1101-0611-04	168	0820IR	1101-2111-01	172	1212BCF	1101-0114-01	164	9795-151-700	9902-1508-20	36	9804-201-08	1102-1420-01	183
0612BCF	1101-0106-01	164	0806AE-M	1101-0611-05	168	0820IR-W	1101-2111-02	172	1212BCF-W	1101-0114-02	164	9801-001-08	1102-0107-01	178	9805-201-08	1102-1415-02	183
0612BCF-W	1101-0106-02	164	0806AE-W	1101-0611-02	168	0821ER	1101-2211-01	172	1213DT	1101-1314-01	171	9801-001-08F	1102-0107-02	178	9806-001-08	1102-0111-01	178
0614VS	1101-1506-01	172	0806EA	1101-0611-01	168	0821ER-W	1101-2211-02	172	1213DT-W	1101-1314-02	171	9801-101-00	1102-0307-01	180	9806-001-08F	1102-0111-02	178
0614VS-W	1101-1506-02	172	0807CP	1101-0711-01	166	0822PR	1101-2311-01	171	1222PR	1101-2314-01	171	9801-102-08	1102-0407-01	180	9806-101-00	1102-0311-01	180
0615VD	1101-1606-01	172	0807CP-B	1101-0711-03	166	0822PR-W	1101-2311-02	171	1222PR-W	1101-2314-02	171	9801-111-08	1102-1007-01	182	9806-102-08	1102-0411-01	180

Cod. fabbrica	Cod. europeo	Pag.	Cod. fabbrica	Cod. europeo	Pag.	Cod. fabbrica	Cod. europeo	Pag.	Cod. fabbrica	Cod. europeo	Pag.	Cod. fabbrica	Cod. europeo	Pag.	Cod. fabbrica	Cod. europeo	Pag.
9806-111-08	1102-1011-01	182	9870-001-08F	1106-0108-02	179	9908-2007-10	9908-2007-10	52	0023GL	1404-1006-04	224	3215DOR	1405-1305-08	215	6868-060-04XT	1306-0209-01	207
9806-112-08	1102-0511-01	180	9902-1507-41	9902-1507-41	34	9908-2008-00	9908-2008-00	52	0024SF	1404-1006-01	225	3225RR	1405-1305-10	216	6868-060-07	1303-0409-01	208
9806-113-08	1102-0611-01	181	9902-1507-42	9902-1507-42	34	9908-2009-00	9908-2009-00	52	0025GT	1404-1006-05	224	4000TG	1703-2500-01	226	6868-060-S	1310-0009-01	210
9806-114-08	1102-0811-01	181	9908-1920-00	9908-1920-00	53	9908-2010-00	9908-2010-00	52	0050NAL	1708-0300-01	240	5001DF	1710-1800-01	238	6868-060-SXT	1311-0009-01	209
9806-115-08	1102-0711-01	181	9908-1921-00	9908-1921-00	53	9908-2011-20	9908-2011-20	52	0341TS	1505-0308-03	198	5002DF	1710-1800-02	238	6868-080-01	1303-0111-01	206
9806-116-08	1102-0911-01	182	9908-1922-00	9908-1922-00	53	9908-2012-50	9908-2012-50	52	0342TS	1505-0307-02	198	5003DF	1710-1800-03	238	6868-080-04	1303-0211-01	206
9806-117-08	1102-2311-01	183	9908-1923-00	9908-1923-00	53	9908-9795-05	9908-9795-05	58	0350SP	1501-0004-03	198	6214SCP-04	1703-1900-03	239	6868-100-01	1303-0113-01	206
9806-200-08	1102-1311-01	183	9908-1924-00	9908-1924-00	53	9908-9795-07	9908-9795-07	58	0351SP	1501-0001-03	198	6234SCP-04	1703-1900-04	239	6868-100-01LC	1302-0113-01	206
9806-201-08	1102-1400-01	183	9908-1925-00	9908-1925-00	53				0450SP	1501-0005-03	198	6404SCP-04	1703-1900-01	239	6868-100-04	1303-0213-01	206
9806-202-08	1102-1111-01	182	9908-1925-50	9908-1925-50	53	<b>Cod. fabbrica</b>	<b>Cod. europeo</b>	<b>Pag.</b>	0451SP	1501-0002-03	198	6501-010-01	1711-1800-01	238	6868-100-04EV	1304-0213-01	207
9807-001-08	1102-0108-01	178	9908-1926-00	9908-1926-00	53	120225	9903-0502-25	193	0501SC	1502-0016-01	200	6501-011-01	1711-1800-02	238	6868-100-04LC	1302-0213-01	207
9807-001-08F	1102-0108-02	178	9908-1926-50	9908-1926-50	53	161720	2500-0059-52	193	0501SC-B	1502-0016-02	200	6501-012-01	1711-1800-03	238	6868-100-04XT	1306-0213-01	207
9807-101-00	1102-0308-01	180	9908-1927-00	9908-1927-00	53	161725	2500-0059-53	193	1000SP	1501-0006-03	198	6501-110-01	1711-1800-04	238	6868-100-07	1303-0413-01	208
9807-102-08	1102-0408-01	180	9908-1928-00	9908-1928-00	53	540261	1405-0901-01	225	1001SP	1501-0003-02	198	6501-111-01	1711-1800-05	238	6868-100-S	1310-0013-01	210
9807-111-08	1102-1008-01	182	9908-1928-50	9908-1928-50	53	540262	1405-0901-02	225	1403-0020-01	1403-0020-01	232	6501-112-01	1711-1800-06	238	6868-100-SXT	1311-0013-01	209
9807-112-08	1102-0508-01	180	9908-1929-00	9908-1929-00	53	0502.00001.001	1504-0943-01	203	1607RU	1405-0101-01	220	6501-113-01	1711-1800-07	238	6868-120-01	1303-0115-01	206
9807-113-08	1102-0608-01	181	9908-1929-10	9908-1929-10	53	0502.00018.040	1505-0308-02	199	1750-1010-01	1750-1010-01	195	6504SCP-04	1703-1900-05	239	6868-120-04	1303-0215-01	206
9807-114-08	1102-0808-01	181	9908-1929-20	9908-1929-20	53	0502.00030.000	1503-1017-01	204	1807RU	1405-0207-01	220	6868-016-FT	1307-0702-01	209	6868-120-04EV	1304-0215-01	207
9807-115-08	1102-0708-01	181	9908-1929-30	9908-1929-30	53	0502.00030.001	1503-1045-01	204	2006FR	1405-0305-06	215	6868-024-04XT	1306-0216-01	207	6868-120-04XT	1306-0215-01	207
9807-116-08	1102-0908-01	182	9908-2000-70	9908-2000-70	52	0503.00001.006	1506-0531-01	194	2007RU	1405-0310-01	220	6868-025-01	1303-0103-01	206	6868-120-S	1310-0015-01	210
9807-117-08	1102-2308-01	183	9908-2000-80	9908-2000-80	52	0508.00006.037	1701-2100-01	241	2012MOR	1405-1105-09	215	6868-025-04	1303-0203-01	206	6868-120-SXT	1311-0015-01	209
9807-201-08	1102-1400-03	183	9908-2000-90	9908-2000-90	52	0508.00007.037	1701-2000-01	241	2012MOR-B	1405-1111-04	215	6868-025-04EV	1304-0201-01	207	6868-245-01	1314-0601-01	209
9807-202-08	1102-1108-01	182	9908-2001-00	9908-2001-00	52	0511.00003.022	1404-1005-02	225	2013AOR	1405-1105-07	214	6868-025-07	1303-0403-01	208	6868-245-01F	1314-0501-01	209
9808-201-08	1102-1400-02	183	9908-2001-10	9908-2001-10	52	0511.00301.033	1406-1005-01	218	2013AOR-B	1405-1111-02	214	6868-025-S	1310-0003-01	210	9780-510-120B	1503-0600-01	202
9810-001-08	1102-0105-01	178	9908-2001-25	9908-2001-25	52	0513.00001.031	1402-0311-01	214	2014COR	1405-1105-06	214	6868-040-04EV	1304-0205-01	207	9780-510-120R	1503-0636-01	202
9810-001-08F	1102-0105-02	178	9908-2001-40	9908-2001-40	52	0513.00004.031	1405-0311-03	216	2014COR-B	1405-1111-01	214	6868-040-04XT	1306-0205-01	207	9780-510-240B	1503-0600-02	202
9810-102-08	1102-0405-01	180	9908-2001-50	9908-2001-50	52	0514.00007.022	1405-1005-01	225	2015DOR	1405-1105-08	215	6868-045-01	1303-0107-01	206	9780-510-240R	1503-0600-03	202
9810-111-08	1102-1005-01	182	9908-2001-60	9908-2001-60	52	0516.00003.001	1703-0500-02	239	2015DOR-B	1405-1111-03	215	6868-045-01LC	1302-0107-02	206	9793-420-121	1214-1102-01	188
9810-112-08	1102-0505-01	180	9908-2001-80	9908-2001-80	52	0516.00003.002	1703-0500-03	239	2100VD	1703-1700-01	240	6868-045-01SM	1301-0107-01	208	9793-420-121 IX	1214-1102-09	188
9810-113-08	1102-0605-01	181	9908-2002-00	9908-2002-00	52	0516.00003.003	1703-0500-04	239	2101BD	1703-1700-03	240	6868-045-04	1303-0207-01	206	9793-450-121	1214-1103-02	188
9810-114-08	1102-0805-01	181	9908-2002-25	9908-2002-25	52	0516.00003.004	1703-0500-05	239	2506FR	1405-0405-07	215	6868-045-04LC	1302-0207-01	207	9793-450-151	1214-1103-01	188
9810-115-08	1102-0705-01	181	9908-2002-50	9908-2002-50	52	0010NAN	1708-1000-02	247	2507RU	1405-0409-01	220	6868-045-04SM	1301-0207-02	208	9793-450-151 IX	1214-1103-09	188
9810-116-08	1102-0905-01	182	9908-2002-80	9908-2002-80	52	0010NBP	1708-1300-02	247	2512MOR	1405-1205-09	215	6868-045-04SM-PP	1301-0207-01	208	9793-480-151	1214-1105-01	188
9820-001-08	1106-0107-01	179	9908-2003-00	9908-2003-00	52	0012EBO	1403-1405-01	230	2513AOR	1405-1205-07	214	6868-045-07	1303-0407-01	208	9793-480-151 IX	1214-1105-09	188
9820-001-08F	1106-0107-02	179	9908-2003-15	9908-2003-15	52	0013EBV	1403-1405-02	230	2514COR	1405-1205-06	214	6868-045-S	1310-0007-01	210	9793-540-202	1214-1107-01	188
9830-001-08	1106-0112-01	179	9908-2003-55	9908-2003-55	52	0014EBO	1403-1505-01	230	2515DOR	1405-1205-08	215	6868-060-01	1303-0109-01	206	9793-600-202	1214-1111-01	188
9830-001-08F	1106-0112-02	179	9908-2004-00	9908-2004-00	52	0015EBV	1403-1505-02	230	2520RR	1405-1205-10	216	6868-060-01LC	1302-0109-02	206	9794-651T	1503-0114-01	202
9840-001-08	1106-0115-01	179	9908-2004-50	9908-2004-50	52	0016TU	1401-0105-01	221	3206FR	1405-0505-07	215	6868-060-01SM	1301-0109-01	208	9898-014	1506-0500-05	193
9840-001-08F	1106-0115-02	179	9908-2005-00	9908-2005-00	52	0018TU	1401-0205-04	221	3207RU	1405-0508-01	220	6868-060-04	1303-0209-01	206	9898-022	1506-0500-06	195
9860-001-08	1106-0111-01	179	9908-2005-60	9908-2005-60	52	0020TU	1401-0305-01	221	3212MOR	1405-1305-09	215	6868-060-04EV	1304-0209-01	207	9898-023	1506-0500-09	195
9860-001-08F	1106-0111-02	179	9908-2006-00	9908-2006-00	52	0021GY	1404-1006-02	224	3213AOR	1405-1305-07	214	6868-060-04LC	1302-0209-01	207	9898-024	1506-0500-01	195
9870-001-08	1106-0108-01	179	9908-2006-30	9908-2006-30	52	0022YU	1404-1006-03	224	3214COR	1405-1305-06	214	6868-060-04SM	1301-0209-01	208	9898-024LN	1506-0500-10	195

Cod. fabbrica	Cod. europeo	Pag.	Cod. fabbrica	Cod. europeo	Pag.	Cod. fabbrica	Cod. europeo	Pag.	Cod. fabbrica	Cod. europeo	Pag.	Cod. fabbrica	Cod. europeo	Pag.	Cod. fabbrica	Cod. europeo	Pag.
9898-024LN mor	1506-0500-11	195	9899-055-01	1406-0903-01	219	9904-104-08	1405-0005-02	217	MS117 105	1201-0004-01	191	MS403	1202-1309-01	190	VS120N	1408-1613-01	233
9898-025	1506-0500-02	194	9899-056-01	1406-0902-01	219	9904-105-08	1405-1205-04	217	MS118 105	1201-0008-01	191	MS404	1202-1314-01	190	VS140	1503-0120-01	202
9898-026	1506-0500-03	193	9899-057-01	1406-1005-02	218	9904-106-08	1405-1205-05	218	MS119 105	1209-0008-01	191	MS405	1202-1316-01	190	VS140	1503-0120-01	233
9898-027	1506-0500-07	194	9899-058-01	1406-0802-01	219	9904-107-00	1405-0405-01	216	MS120 206	1201-1202-01	191	MS406	1202-1313-01	190	VS140N	1503-0120-02	233
9898-028	1506-0500-04	194	9899-059-01	1406-0803-01	219	9905-001-08	1402-0505-01	214	MS121 105	1201-0012-01	191	MS502	1202-1406-01	190	VS140N	1503-0120-02	202
9898-029-01	1505-0007-01	198	9899-060-01	1404-0005-08	219	9905-101-08	1405-1305-01	216	MS122 133	1209-0013-01	191	MS503	1202-1409-01	190	VS210	1408-1712-01	233
9898-031-01S	1501-0002-02	198	9899-061-01	1404-0005-09	219	9905-102-08	1405-1305-02	217	MS150	1202-0006-06	191	MS504	1202-1414-01	190	VS210N	1408-1713-01	233
9898-032-01S	1501-0001-02	198	9899-062-01	1404-0005-01	219	9905-103-08	1405-1305-03	217	MS151	1202-0009-03	191	MS505	1202-1416-01	190	VS220	1408-1712-02	233
9898-033-01	1500-0010-01	199	9899-064-01	1403-3000-01	232	9905-105-08	1405-1305-04	217	MS153	1202-0014-01	191	MS742 304	1221-0202-01	186	VS220N	1408-1713-02	233
9898-035-01S	1501-0005-02	198	9899-065-01	1404-1105-01	220	9905-106-08	1405-1305-05	218	MS215 133	1212-0408-01	187	MS765 304	1221-0204-01	186	VS240	1503-0121-01	202
9898-036-01S	1501-0004-02	198	9899-066-01	1404-0005-02	220	9905-107-00	1405-0505-01	216	MS215 N133	1212-0408-02	187	MS801	1202-1515-01	190	VS240	1503-0121-01	233
9898-037-01GIA	1502-0024-02	199	9899-067-01	1404-0005-03	220	A-100-030	1703-1700-02	240	MS216 133	1212-0413-02	187	MS802	1202-1518-01	190	VS240N	1503-0121-02	202
9898-037-95GIA	1502-0024-01	199	9899-068-01	1404-0005-04	220	AV108	1506-0537-01	195	MS216 N133	1212-0413-01	187	MS803	1202-1517-01	190	VS240N	1503-0121-02	233
9898-040-01	1505-0008-01	198	9899-069-01	1403-3000-02	232	AV301	1506-0038-01	194	MS217 133	1212-0414-01	187	MS804	1202-1519-01	190			
9898-052-01	1500-0025-01	199	9899-070-01	1404-0005-10	223	AV302	1506-0538-01	195	MS217 N133	1212-0414-02	187	MT600 212	1213-0003-01	192			
9899-001-01	1403-1914-01	230	9899-071-01	1404-0005-05	219	AV401	1506-0040-02	194	MS218 233	1212-0915-01	187	MT630 101	1213-0202-01	192			
9899-002-01	1403-2215-01	230	9899-072-01	1404-0005-06	219	BVC9898-01SP	1502-0026-03	201	MS218 N233	1212-0915-02	187	MT650 101	1213-0206-01	192			
9899-006-01	1403-2317-01	231	9899-073-01	1404-0005-11	223	BVC9898-01SV	1502-0026-01	201	MS220 105	1205-0204-02	187	PVL9898-01SV	1502-0027-01	201			
9899-007-801	1711-1800-08	238	9899-073-01N	1404-0305-04	223	BVC9898-95SP	1502-0026-04	201	MS223 105	1205-0308-01	187	PVL9898-95SV	1502-0027-02	201			
9899-008-01	1403-2516-02	231	9899-075-01	1404-0005-07	223	BVC9898-95SV	1502-0026-02	201	MS230 106	1203-0202-01	186	SB9898-01SV	1502-0028-02	200			
9899-009-01	1403-2516-01	231	9899-080	1702-2200-01	241	BVL9898-01SP	1502-0030-01	201	MS230 206	1203-0702-01	186	SB9898-01SV	1502-0028-03	200			
9899-023-01	1409-0005-01	226	9899-081	1702-2200-02	241	BVL9898-01SV	1502-0030-02	201	MS253 105	1203-0204-06	186	SB9898-95SV	1502-0028-01	200			
9899-027-01	1409-0005-02	226	9899-082	1702-2200-03	241	BVL9898-95SP	1502-0030-03	201	MS253 107	1203-0204-02	188	SB9898-95SV	1502-0028-04	200			
9899-040-01	1404-0105-01	221	9899-083	1702-2200-04	241	BVL9898-95SV	1502-0030-04	201	MS253N105	1203-0204-04	186	SP700	1503-0113-01	203			
9899-041-01	1404-0305-01	221	9899-098-01-RES	1408-0005-04	234	BVP9898-01SP	1502-0025-01	200	MS255 107	1203-0202-02	188	SP701	1503-0113-02	203			
9899-042-01	1404-0105-02	222	9899-098-01S	1408-0005-03	234	BVP9898-95SP	1502-0025-02	200	MS257 105	1203-0208-04	186	SP740	1503-0114-04	203			
9899-042-01-U	1404-1005-01	223	9899-099-01-RES	1408-0005-02	234	C9794-300	1503-1323-02	204	MS257 107	1203-0208-01	188	SP741	1503-0114-05	203			
9899-042-01-Y	1404-0105-05	222	9899-099-01S	1408-0005-01	234	C9794-300T	1503-1323-01	204	MS257N105	1203-0208-03	186	SP850	1503-0129-01	203			
9899-043-01	1404-0305-05	222	9899-220-01	1403-1920-01	230	C9899-01	1400-0005-01	232	MS258 105	1203-0212-02	186	SP930	1503-0111-01	204			
9899-043-01-Y	1404-0205-01	222	9899-221-01	1403-2119-01	231	C9899-32	1400-0005-02	232	MS258 107	1203-0212-01	188	SP930N	1503-0111-02	204			
9899-044-01	1404-0205-02	222	9903-001-08	1402-0305-01	214	MC700 300	1204-0002-01	192	MS258N105	1203-0212-03	186	SP940	1503-0112-02	204			
9899-044-01-Y	1404-0305-06	222	9903-101-08	1405-1105-01	216	MS105	1202-0002-01	189	MS263111	1203-0204-05	186	SP940N	1503-0112-01	204			
9899-045-01	1404-0105-04	221	9903-102-08	1405-1105-02	217	MS105 102	1202-0002-04	189	MS264111	1203-0208-05	186	SP960	1503-0211-01	204			
9899-045-01-Y	1404-0005-12	222	9903-103-08	1405-1105-03	217	MS105 302	1202-0002-03	189	MS291 133	1208-0408-01	187	SP960N	1503-0211-02	204			
9899-046-01	1404-0305-02	221	9903-104-08	1405-0005-01	217	MS106	1202-0006-01	189	MS291 N133	1208-0408-02	187	SP970	1503-0212-01	204			
9899-046-01-Y	1404-0005-13	222	9903-105-08	1405-1105-04	217	MS106 110	1202-0006-04	189	MS293 133	1208-0413-01	187	SP970N	1503-0212-02	204			
9899-047-01	1404-0105-03	222	9903-106-08	1405-1105-05	218	MS106 303	1202-0006-03	189	MS293 N133	1208-0413-02	187	UT100 300	1701-1600-01	241			
9899-047-01-Y	1404-0005-14	222	9903-107-00	1405-0305-01	216	MS111	1202-0002-05	191	MS295 133	1208-0414-01	187	UT200 300	1701-1400-01	241			
9899-048-01	1404-0305-03	222	9904-001-08	1402-0405-01	214	MS112	1202-0002-02	191	MS295 N133	1208-0414-02	187	UT400 300	1701-1500-01	241			
9899-049-01	1404-0205-03	222	9904-101-08	1405-1205-01	216	MS116	1202-0006-02	189	MS297 233	1208-0915-02	187	VS110	1408-1612-02	233			
9899-050-01	1406-0905-01	218	9904-102-08	1405-1205-02	217	MS116 107	1202-0009-02	189	MS297 N233	1208-0915-01	187	VS110N	1408-1613-02	233			
9899-051-01	1406-0805-01	218	9904-103-08	1405-1205-03	217	MS116 304	1202-0009-01	189	MS402	1202-1306-01	190	VS120	1408-1612-01	233			

# CONDIZIONI GENERALI DI VENDITA IN ITALIA

Voce	Descrizione
<b>VALIDITÀ</b>	Il presente listino entra in vigore in data 1 Febbraio 2026
<b>PREZZI</b>	I prezzi esposti nel presente listino possono subire variazioni senza preavviso.
<b>IVA</b>	I prezzi si intendono I.V.A. esclusa.
<b>IMBALLO</b>	Compreso nel prezzo di listino (imballi speciali e pallets al costo).
<b>RESA</b>	La merce viaggia sempre a rischio e pericolo del committente. Franco stabilimento
<b>RECLAMI</b>	Eventuali reclami per merce mancante o danneggiata devono essere sempre accompagnati dal documento di trasporto sul quale è stata apposta riserva per materiale danneggiato o mancante firmata dal vettore. Non verranno accettati reclami trascorsi 8 giorni dal ricevimento della merce.
<b>RESI</b>	Non si accettano resi senza autorizzazione scritta di GIA S.r.l. I resi non imputabili a GIA S.r.l. saranno assoggettati ai costi di gestione.
<b>PAGAMENTI</b>	In caso di ritardato pagamento rispetto al convenuto verranno conteggiati gli interessi di mora ai sensi di legge.
<b>GARANZIA</b>	Conforme alla normativa vigente. Un'adeguata polizza assicurativa per la "Responsabilità Civile Prodotti" è a supporto della garanzia.
<b>FORO</b>	Per ogni controversia è competente solo il Foro di Novara.
<b>QUANTITÀ MINIMA</b>	La quantità minima di vendita per ogni referenza è rappresentata dalla quantità per imballo salvo eccezioni su determinati prodotti.

GIA S.r.l. si riserva il diritto di modificare i suoi prodotti in qualsiasi momento e senza preavviso, per esigenze di carattere tecnico e/o commerciale.  
Per i dati tecnici e le schede tecniche di riferimento dei prodotti di GIA S.r.l. considerare quanto riportato sul sito [www.gia.it](http://www.gia.it).

GIA, FLIP SYSTEM, EnerGIA, GIOLLI e GICOLLAR sono marchi registrati e di proprietà di Gia S.r.l.  
SUMO è un marchio registrato e di proprietà di Niccons Italy S.r.l.  
CANALSPLIT è un marchio registrato e di proprietà di Artiplastic Macos S.r.l.  
ACQUARING e RAPID-O è un marchio registrato e di proprietà di Castel Engineering S.r.l.

LIST28/02\_2026ITA

Copyright © 2026 Gia Srl



Di seguito i termini "noi", "nostro", "nostro/a", "ci" si riferiscono a DiversiTech® Corporation e affiliate o società consociate.

I prodotti citati nel presente documento sono destinati ad essere acquistati, installati, periodicamente controllati e mantenuti solo da professionisti specializzati in Riscaldamento, Ventilazione, Aria condizionata o Refrigerazione (HVAC-R) che dovrebbero avere un know-how professionale sufficiente per selezionare il prodotto giusto in base all'uso previsto e all'installazione. Qualsiasi smaltimento del prodotto è a esclusiva e completa responsabilità e spese dell'installatore e deve essere effettuato nel rispetto di tutte le normative in vigore presso il sito di installazione. Consigliamo ai nostri clienti di verificare che i prodotti scelti siano adeguati all'uso previsto, poiché la loro applicazione, utilizzo, esecuzione, installazione e manutenzione esulano dal nostro controllo.

Coloro che in qualsiasi modo maneggiano i nostri prodotti sono gli unici responsabili di determinare (a) l'idoneità dei prodotti all'uso previsto, (b) le modalità appropriate di lavorazione e manutenzione del prodotto per garantirne la sicurezza e la qualità e (c) gli effetti chimici, fisici e sulla salute correlati a tali attività, (d) informarsi per poter decidere se sono necessari dati specifici prima dell'installazione in relazione alle condizioni climatiche e ambientali, alle norme e ai regolamenti in vigore nei luoghi di stoccaggio e installazione, (e) controllare se la struttura di supporto su cui saranno installati i prodotti è sufficientemente resistente per l'uso previsto, (f) utilizzare strumenti e materiali di fissaggio adeguati per l'installazione e la manutenzione. I clienti, gli installatori e terzi sono gli unici responsabili per danni o malfunzionamenti derivanti da uso improprio, abuso, negligenza o manipolazione, trasporto o conservazione inadeguati. Fino all'installazione i nostri prodotti devono rimanere nella loro confezione originale, al riparo da possibili condizioni climatiche avverse. La nostra garanzia è limitata esclusivamente alla fornitura di un prodotto di qualità costante secondo i nostri standard. Se la nostra responsabilità per il prodotto è confermata, la garanzia limitata sarà solo quella, a nostra esclusiva discrezione, di mettere a disposizione prodotti sostitutivi equivalenti o simili, conformi ai nostri standard di qualità, in sostituzione dei prodotti considerati difettosi.

Nonostante la cura con cui concepiamo e produciamo i nostri prodotti, una piccola differenza di colore può essere notata tra lotti di diversi cicli di produzione. Ciò è inerente ai nostri processi di produzione e ai limiti tecnologici delle nostre apparecchiature. Quando menzionato, le dimensioni sono arrotondate e non sono destinate a scopi di produzione. Si applicano le tolleranze. Salvo diversamente specificato nel documento, tutti i dati, ogniqualvolta sia implicito o richiesto un fattore di sicurezza o un parametro di sicurezza da prendere in considerazione, sono espressi senza tali indicazioni. Le schede tecniche sono disponibili su richiesta scritta. Ci riserviamo il diritto di modificare tutti i dati contenuti in questo documento senza preavviso. Consigliamo di contattarci prima di proporre i nostri prodotti ai vostri clienti. Le informazioni contenute in questo documento sono state attentamente controllate e si ritiene che siano accurate. Tuttavia, non si assume alcuna responsabilità né per la traduzione né per la tipografia, né per gli errori di correzione delle bozze né per le omissioni. A causa dell'evoluzione delle norme, dei materiali, delle attrezzature o per altri motivi, le caratteristiche indicate nel testo o nelle rappresentazioni o illustrazioni o nei disegni e i prodotti raffigurati nel presente documento non sono vincolanti per noi fino a quando non saranno state specificatamente confermate dai nostri servizi.

Salvo diversa indicazione, in tutte le nostre comunicazioni, listini prezzi, preventivi, conferme d'ordine e altri documenti commerciali, tutti i nostri prezzi sono sempre espressi senza tasse. Gli acquisti effettuati presso DiversiTech® Corporation o i suoi affiliati sono soggetti alle Condizioni Generali di Vendita.

Tutte le immagini e i disegni in questa pubblicazione sono solo a scopo illustrativo. I dati possono cambiare senza preavviso e sono soggetti a tolleranze. DiversiTech® Corporation, i suoi affiliati e i suoi distributori non possono essere ritenuti responsabili per errori tipografici, errori di layout o disinformazione tecnica contenuti nel presente documento. Questo catalogo annulla e sostituisce tutte le versioni precedenti. È responsabilità esclusiva dei clienti richiedere di ottenere la versione più recente in vigore di questo catalogo.

Copyright 2026 - DiversiTech® Corporation - Tutti i diritti riservati, compreso il diritto di traduzione.



# SIMPLIFY YOUR WORK

GIA S.r.l.

28069 TRECATE (NO) Italy  
Via Sac. A. Cremona,12  
Tel. +39/031.777142 r.a.  
Fax +39/031.770337  
info@gia.it

C.F. e P.IVA 07245050963  
Numero REA NO-229867  
Reg. Imprese: NO 07245050963  
Cap. Soc. Euro 1.176.471,00 i.v.  
Società soggetta a direzione e  
coordinamento di  
"DiversiTech Corporation Inc."



[www.gia.it](http://www.gia.it)



[diversitech-europe.com](http://diversitech-europe.com)

Assistenza tecnica

[assistenza@gia.it](mailto:assistenza@gia.it)

Supporto tecnico

0321.77.71.42