

Ventilation heat exchanger NIBE ERS S10-400

The NIBE ERS S10-400 are heat recovery ventilation units with high temperature efficiency up to 92% and low energy consumption. The NIBE ERS 10 is used in houses with areas up to approx. 300 m², NIBE ERS 20 up to approx. 200 m².

The NIBE ERS S10-400 are designed for installation with a NIBE ground source heat pump or a NIBE air/water heat pump for a complete heating and ventilation system. The heat recovery ventilation units are easily controlled by the heat pump.

Thanks to smart technology, the product gives you control over your energy consumption and will be a key part of your connected lifestyle. The efficient control system automatically adjusts the indoor climate for maximum comfort, and you do nature a favour at the same time.

- The heat recovery ventilation units with high temperature efficiency and low energy consumption.
- Together with the NIBE ground source or air/water heat pump, it provides an integrated solution in houses with balanced ventilation.
- Easy to control and part of your smart home in combination with a NIBE heat pump.
- Integrated bypass-function.



This is how ERS S10 works

Principle

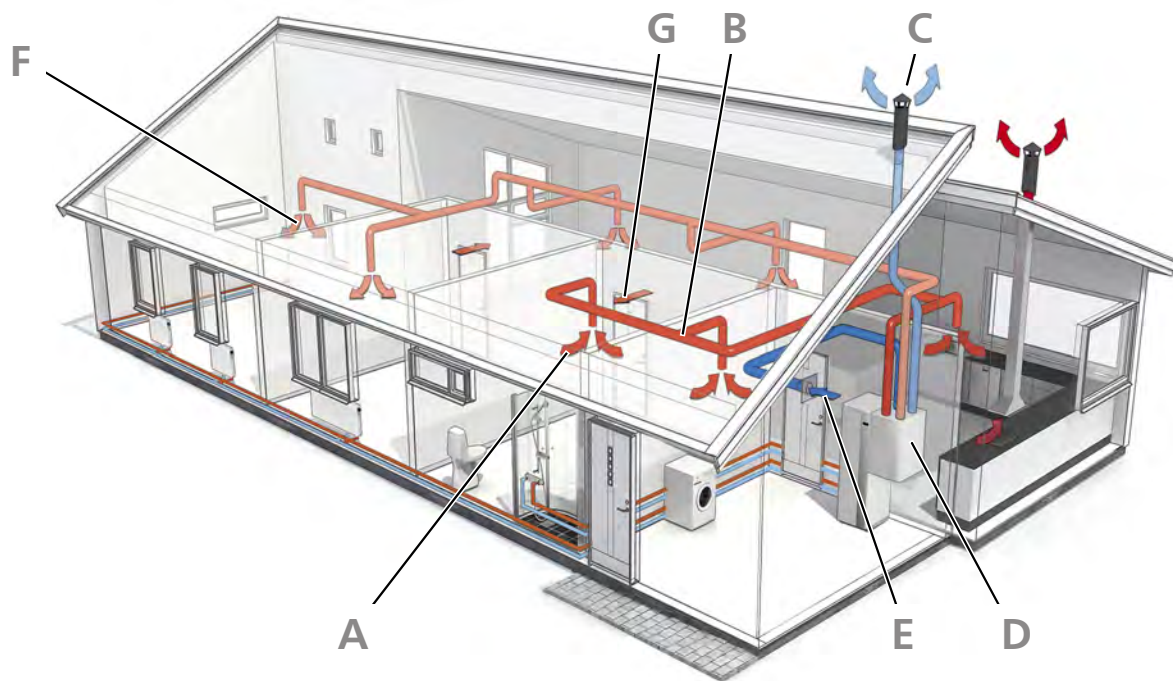

The figure shows ERS 10.

ERS S10 is a ventilation heat exchanger with inbuilt fans and counter-current heat exchanger.

Energy is recovered from the ventilation air and supplied to your home, which reduces energy costs considerably.

The unit is intended for both new installations and replacement in houses or similar.

ERS S10 is suitable for ventilation systems where high temperature efficiency and low energy consumption are required. ERS 10 is normally used in homes with an area of up to approx. 300 m², ERS 20 to approx. 200 m².

- A** The warm room air is drawn into the air duct system.
- B** The warm room air is fed to ERS S10.
- C** The room air is released when it has passed ERS S10. The air temperature has then been reduced as ERS S10 has extracted the energy in the room air.
- D** ERS S10 ventilates your home and heats the supply air.
- E** Outdoor air is drawn into ERS S10.
- F** Air is blown out into rooms with supply air inlets.
- G** Air is transported from rooms with supply air inlets to rooms with exhaust air valves.

Good to know about ERS S10

Transport and storage Installation and positioning

ERS S10 should be transported and stored in the dry.

Supplied components

ERS 10

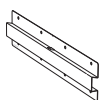

Rail for wall mounting

ERS 10 is installed using the enclosed rail on a solid wall. ERS 20 is installed in the roof using the enclosed roof brackets. Noise from the fans can be transferred to the brackets.

- Wherever the unit is located, walls to sound sensitive rooms should be fitted with sound insulation.
- Condensation comes from the ventilation heat exchanger. A condensation outlet with a water seal must be installed and routed to an internal drain.
- The ventilation heat exchanger's installation area should always have a temperature of at least 10 °C and max. 35 °C.

INSTALLATION AREA

ERS 10

Leave a free space of 800 mm in front of the product.

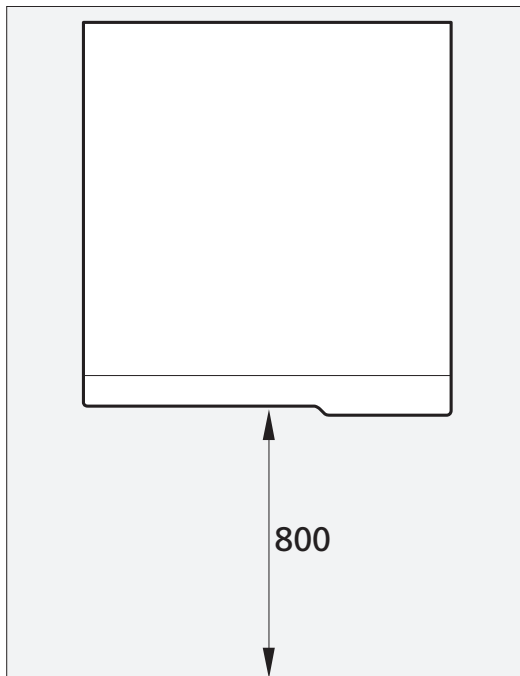

Ensure that there is necessary space (300 mm) above the exhaust ventilation heat exchanger for installing ventilation hoses.

Installation

Condensation water drain

ERS S10 can produce several litres of condensation water per day. It is therefore important for the condensation outlet to be correctly executed and for the ventilation heat exchanger to be installed horizontally.

Check that the water seal is airtight and firmly in position. The connection must be made so that the user can check and top up the water seal, without opening ERS S10.

The connection for the condensation outlet on ERS 20 measures $\varnothing 15$ mm. On ERS 10, the condensation outlet is adapted for the type of water seal that is traditionally used for a wash basin (connection G32).

Ventilation

- Connect ERS S10 so that all the exhaust air, except kitchen duct air (kitchen fan), passes through the heat exchanger in the product.
- The ventilation flow must comply with the applicable national standards.
- The supply air flow must be lower than the exhaust air flow to prevent over pressure in the house.
- The air duct system must be a minimum of air tightness class B.
- To prevent fan noise being transferred to the ventilation devices, silencers should be installed in the duct system. In the event of ventilation devices in noise-sensitive rooms, silencers must be installed.
- When the extract air and outdoor air temperature is/becomes cold, the extract air and outdoor air duct must be insulated using diffusion-proof material (at least PE30 or equivalent) along its entire length.
- Exhaust air ducts that are routed in cold areas must be insulated.
- All joints in the ducting must be sealed to prevent leakage.
- The air must be routed to the outdoor air duct through an outer wall grille in the facade. The outer wall grille must be installed so that it is protected from the weather and must be designed so that no rainwater and/or snow can penetrate the facade or follow the air into the duct.
- When positioning the outdoor air and extract air hood/grille, bear in mind that the two air flows must not short circuit to prevent the extract air from being drawn into ERS S10 again.
- A duct in a masonry chimney stack must not be used for extract air or outdoor air.
- If a stove or similar is installed, it must have airtight doors. It must also be able to take combustion air from outside.
- Incorrect adjustment of the ventilation may lead to reduced installation efficiency and thus poorer operating economy, and may cause moisture damage in the building

SETTING THE FAN CAPACITY

Select the ventilation capacity steplessly in the display.

Ventilation capacity ERS 10

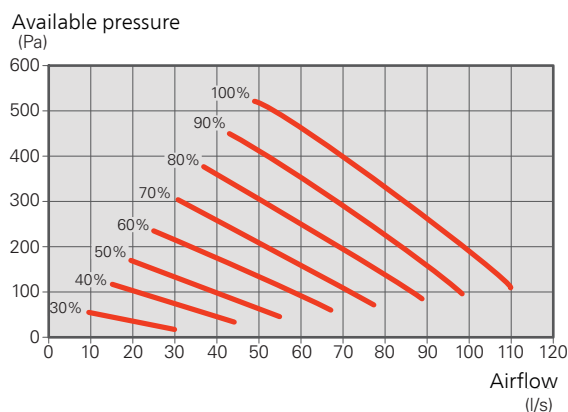

Fan output¹ ERS 10

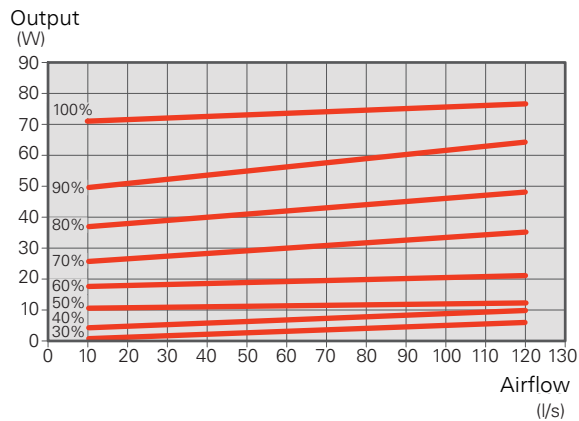

¹The diagram shows the power consumption per fan.

VENTILATION CONNECTIONS

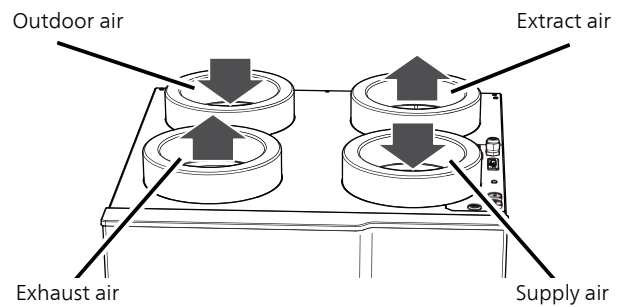

Electrical connections

- Disconnect ERS S10 before insulation testing the house wiring.
- To prevent interference, sensor cables to external connections must not be laid close to high voltage cables.
- If the supply cable is damaged, only NIBE, its service representative or similar authorised person may replace it to prevent any danger and damage.

ERS S10 is equipped with a communication cable from the factory (cable length 2.0 m), which is connected to a circuit board in the heat pump. It is also equipped with a supply cable with a plug (cable length 2.4 m).

Electrical installation and service must be carried out under the supervision of a qualified electrician. Electrical installation and wiring must be carried out in accordance with the stipulations in force.

Functions



Using the Internet and myUplink for the S-series and NIBE Uplink for the F-series, you can obtain a quick overview and the present status of the installation and the heating in your home. You can obtain a good overall view, allowing you to monitor and control the heating and hot water comfort efficiently. If the installation is affected by a malfunction, you receive a reliable alert via e-mail that allows you to react quickly.

myUplink / NIBE Uplink also gives you the opportunity to easily control the comfort in the home, no matter where you are.

You have access to different levels of service via myUplink / NIBE Uplink. A basic level that is free and a premium level where you can select different extended service functions for a fixed annual subscription fee (the subscription fee varies depending on the selected functions).

The service is also available as an app from App Store and Google Play.

Accessories

Detailed information about the accessories and complete accessories list available at nibe.se.

Electric air heater EAH

In cold weather, EAH heats the outdoor air slightly to prevent condensation in ERS S10 from freezing. Used mainly in colder climates.

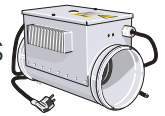

EAH 10-1800 (450-900 W)

Part no. 067 567

EAH 20-900 (300-900 W) EAH 20-1800 (300-1800 W)

Part no. 067 604

Part no. 067 603

Top cabinet

Top cabinet that conceals the ventilation ducts and reduces the sound to the installation room.

Height 245 mm Height 345 mm

Part no. 089 756 Part no. 089 757

Height 445 mm Height 385-635

Part no. 067 522 *mm*

Part no. 089 758

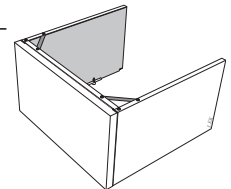

Technical data

Dimensions

ERS 10

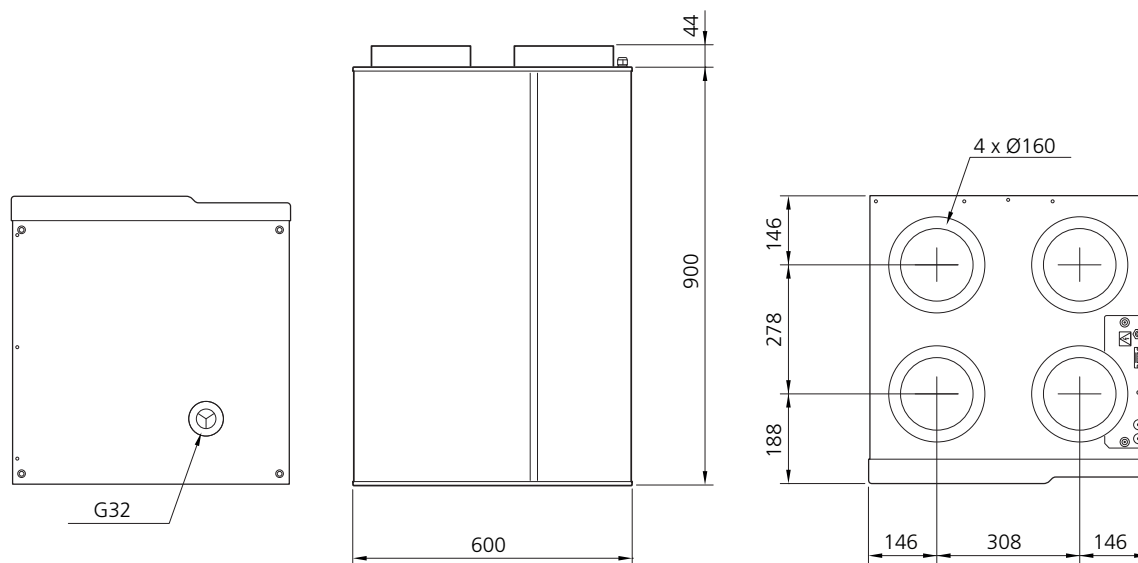

EAH 20

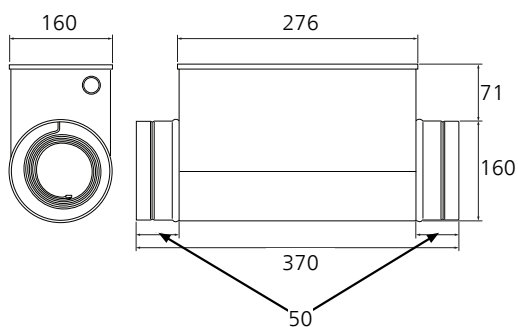

Technical specifications

Type		ERS S10
<i>Electrical data</i>		
Supply voltage	V	230 V ~ 50Hz
Fuse	A	10
Driving power fan	W	2 x 85
Enclosure class		IP X1
<i>Ventilation</i>		
Filter type, exhaust air filter		ISO Coarse
Filter type, supply air filter		ePM1 55%
<i>Sound levels</i>		
Sound power level ($L_{W(A)}$) ¹	dB(A)	47
Sound pressure level ($L_{P(A)}$) at 1 m ²	dB(A)	-
Sound pressure level ($L_{P(A)}$) at 1 m ³	dB(A)	-
<i>Pipe connections</i>		
Ventilation Ø	mm	160
Condensation water drain Ø	mm	G32
<i>Miscellaneous</i>		
Efficiency class ⁴		A
Length, supply cable	m	2.4
Length, control cable	m	2.0
Width	mm	600
Height	mm	900
Depth	mm	612
Weight	kg	40
Part No.		066 163

1 277 m³/h (77 l/s) at 50 Pa

2 105 m³/h at 50 Pa

3 250 m³/h at 140 Pa

4 Scale for efficiency class: A+ to G.

Dry temperature efficiency according to EN 308

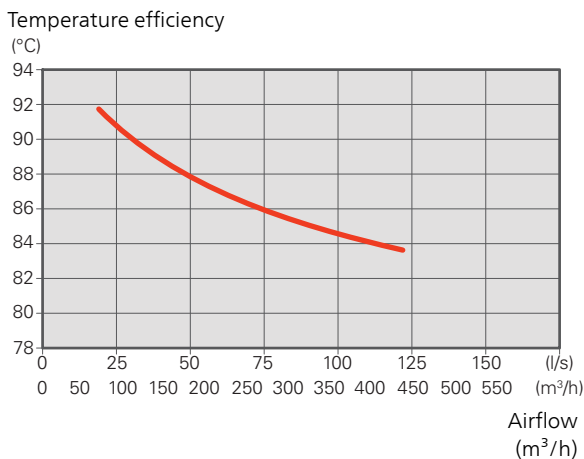

Outdoor air: 5 °C Exhaust air 25 °C RH exhaust air: <27.7 %



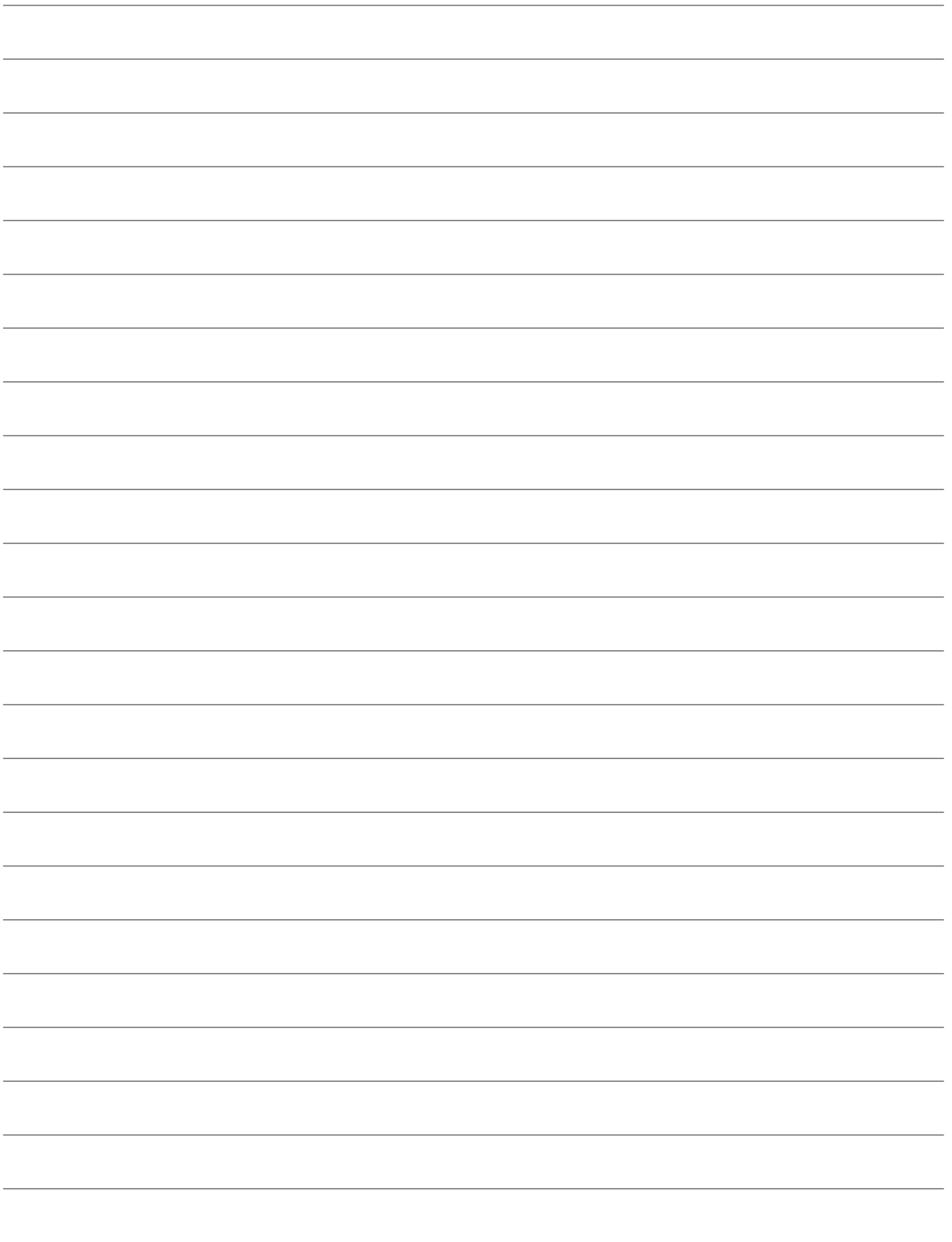

This product sheet is a publication from NIBE Energy Systems. All product illustrations, facts and data are based on current information at the time of the publication's approval. NIBE Energy Systems makes reservations for any factual or printing errors in this product sheet.